

**eduard**  
**Express Mask**

**XS 526**

# P-47 National Insignia 1942-43

FOR 1/72 KIT

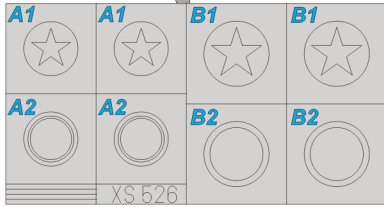

### REFERENCES:

AERO DETAIL # 14  
IN DETAIL & SCALE VOL.54

John M. Elliott  
THE OFFICIAL MONOGRAM  
US NAVY & MARINE CORPS  
AIRCRAFT COLOR GUIDE  
(vol.2 1940-1949)

1.)

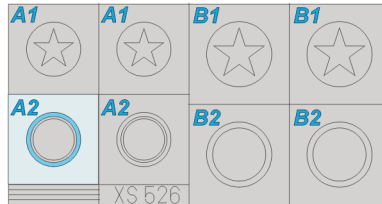
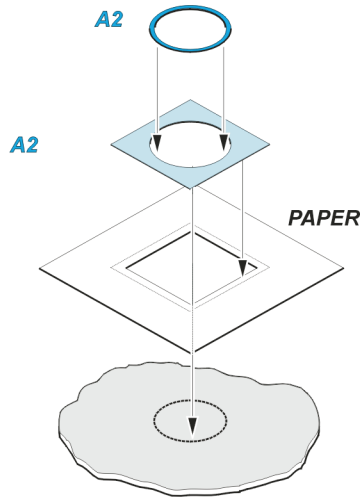

2.)

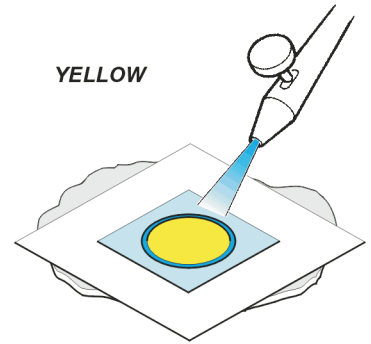

3.)

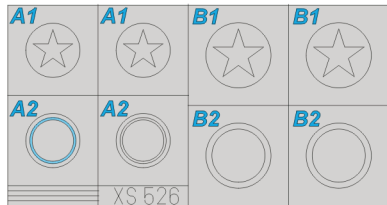
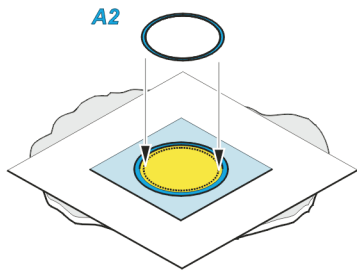

4.)

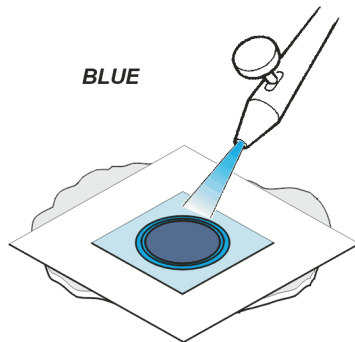

5.)

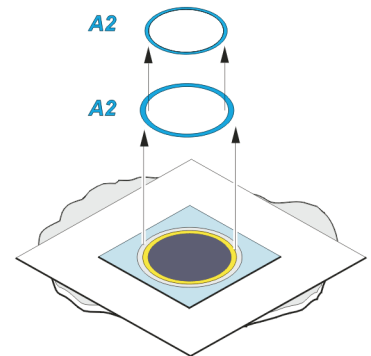

6.)

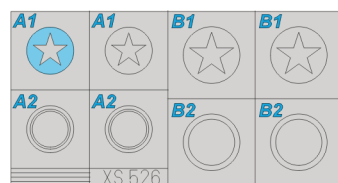
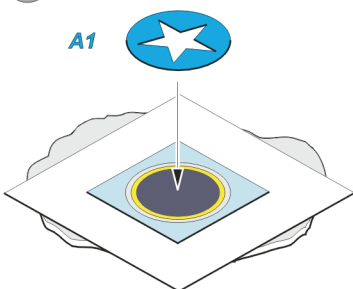

7.)

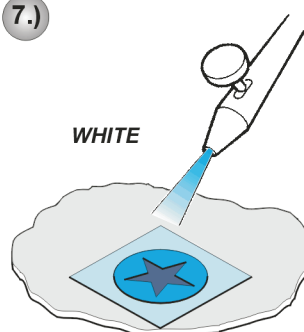

8.)

