

**eduard**  
**Express Mask**

**XS 252**

# A-6 Intruder

The die-cut mask for accurate canopy frame painting of the  
*KANGNAM 1/72 KIT*

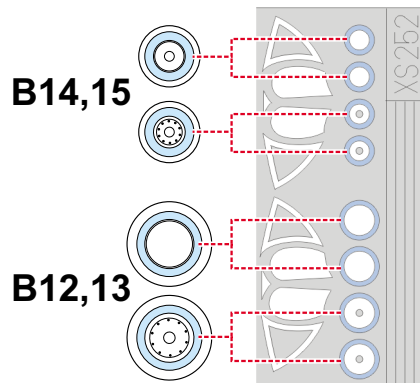
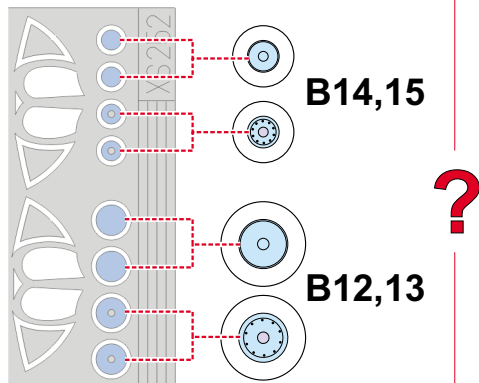
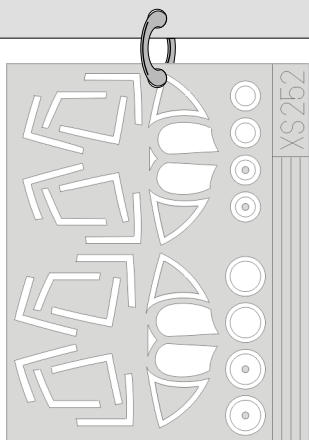

 - LIQUID MASK  
MASCOL

1.)

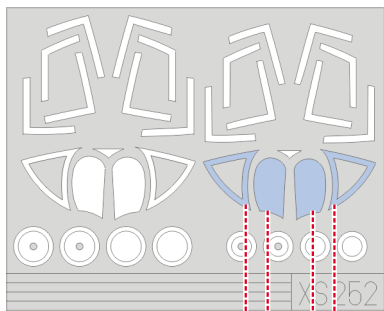

CANOPY

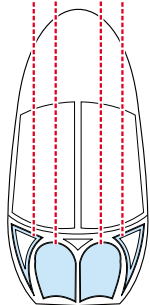

2.)

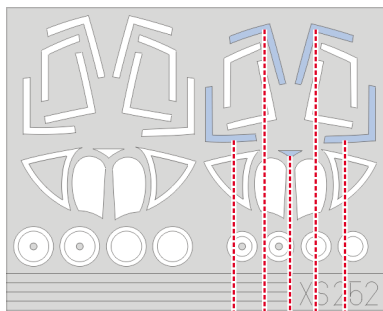

CANOPY

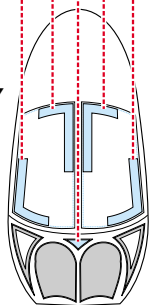

3.)

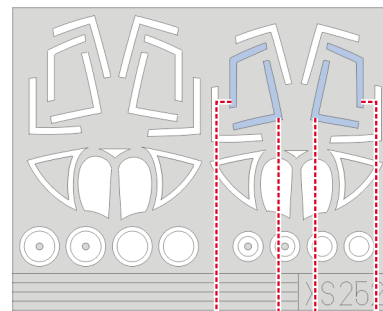

CANOPY

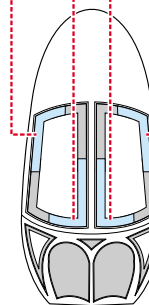

4.)

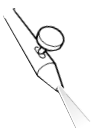

INTERIOR COLOR  
BARVA INTERIÉRU

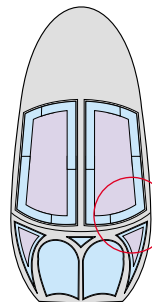

6.)

REMOVE MASK  
ODSTRANIT MASKU

5.)

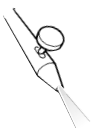

RUBBER COLOR  
BARVA GUMY

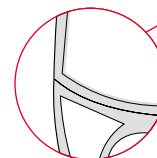
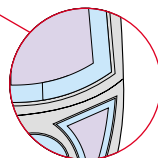

 - LIQUID MASK  
MASCOL

7.)

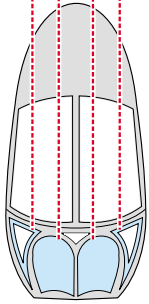
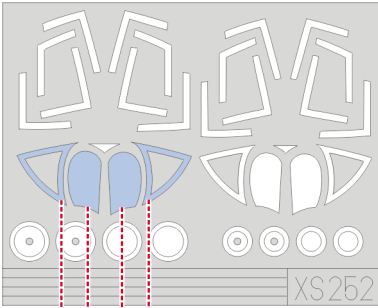

8.)

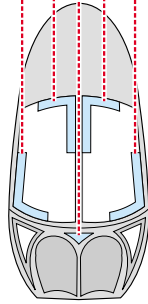
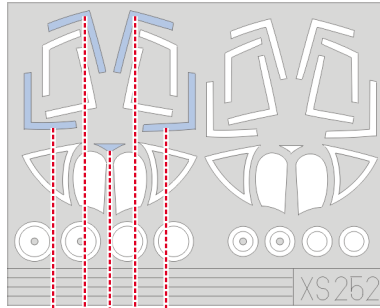

9.)

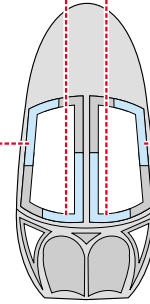
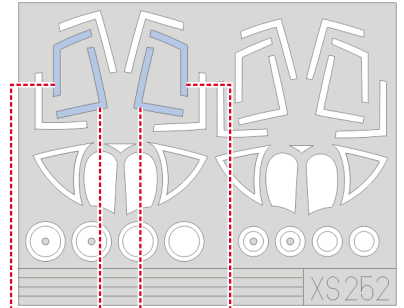

10.)



CAMOUFLAGE COLOR  
BARVA KAMUFLÁŽE

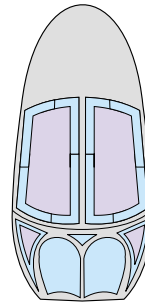

LIQUID MASK  
MASCOL

11.)

REMOVE MASK  
ODSTRANIT MASKU

