

eduard
Express Mask

B-25H Mitchell

The die-cut mask for accurate canopy frame painting of the
Hasegawa 1/72 KIT

XS 244

LIQUID
MASK



2pcs.
E7



2pcs.
E6



C21



2pcs.
K4



2pcs.
E7

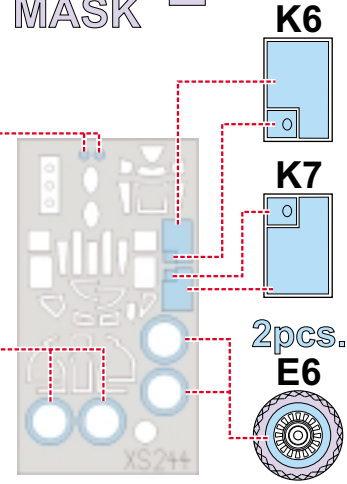

K6



K7



2pcs.
E6

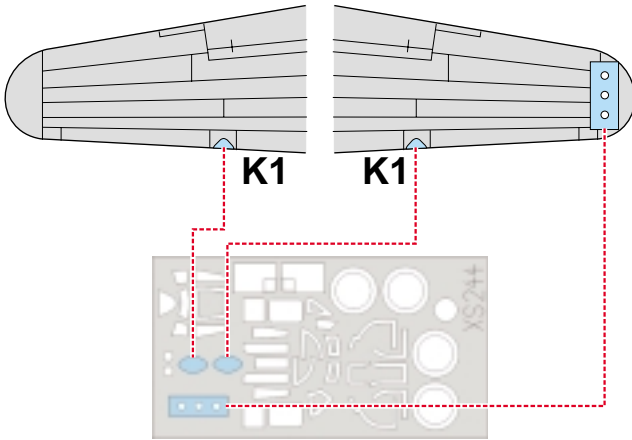

K1

K1

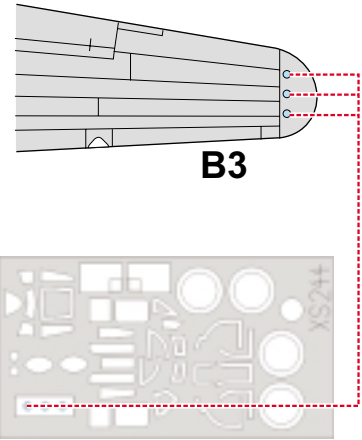

B3

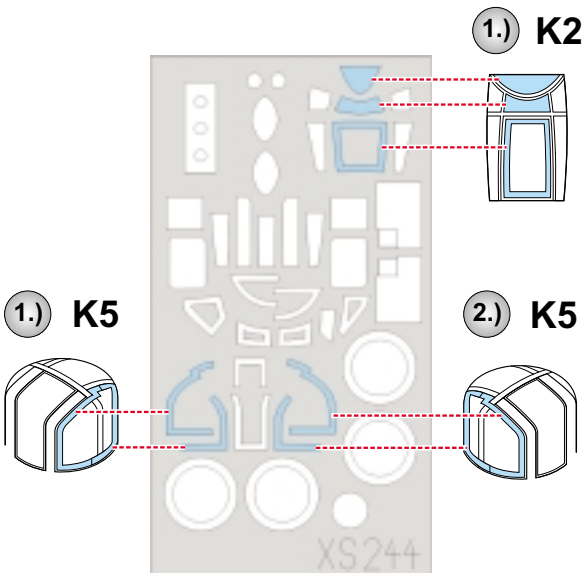

1.) K5

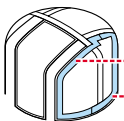

2.) K5

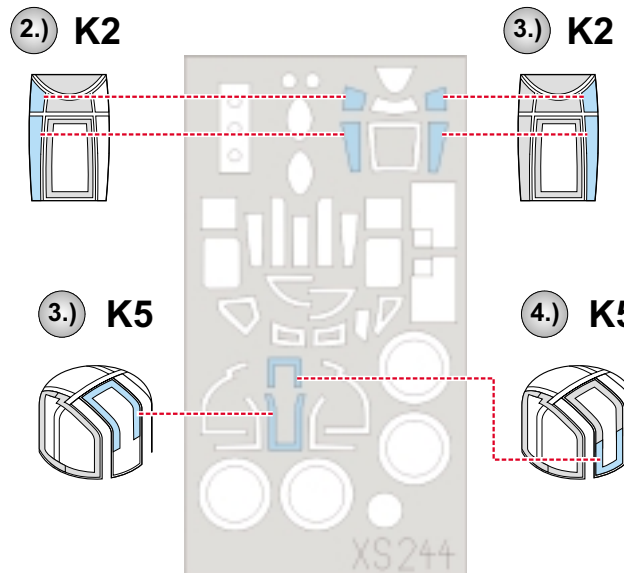
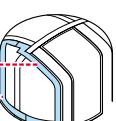

2.) K2

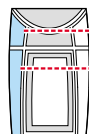

3.) K2

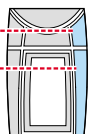

3.) K5

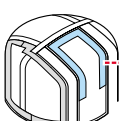

4.) K5

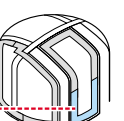

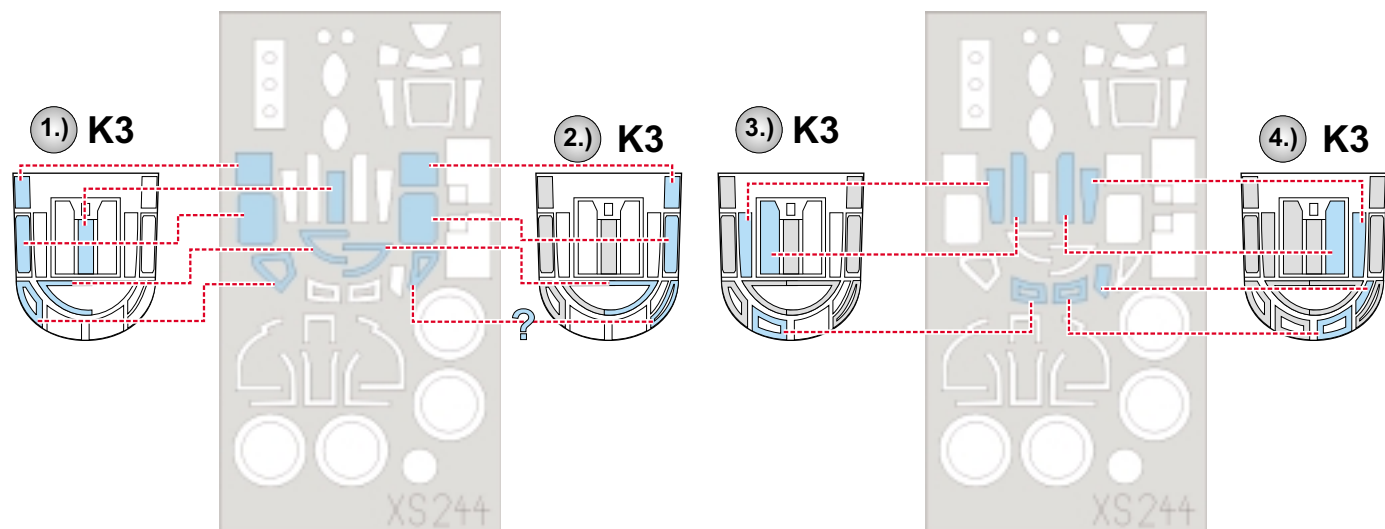

 - LIQUID MASK
MASCOL

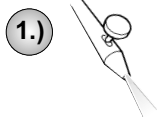

1.) INTERIOR COLOR
BARVA INTERIÉRU

K2

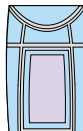

K3

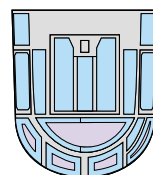

K5

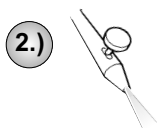
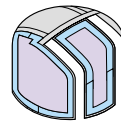

2.) CAMOUFLAGE COLOR
BARVA KAMUFLÁ E

K2

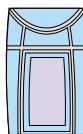

K3

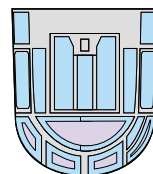

K5

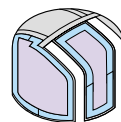

3.) REMOVE MASK
ODSTRANIT MASKU

K2

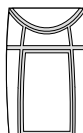

K3

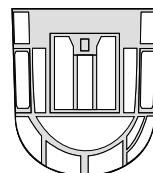

K5

