

eduard
Express Mask

XS 208

F-15 A/C

The die-cut mask for accurate canopy frame painting of the
Hasegawa 1/72 KIT

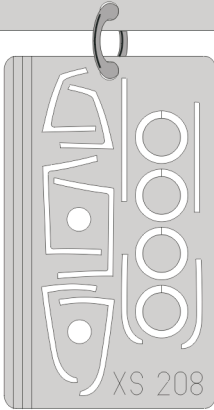

A18



A18

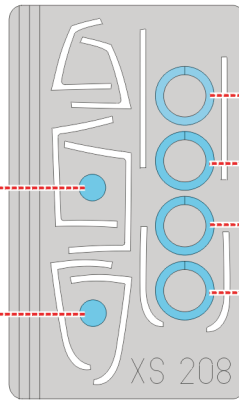

D19
2pcs.



D19
2pcs.

LIQUID MASK ■

1.)

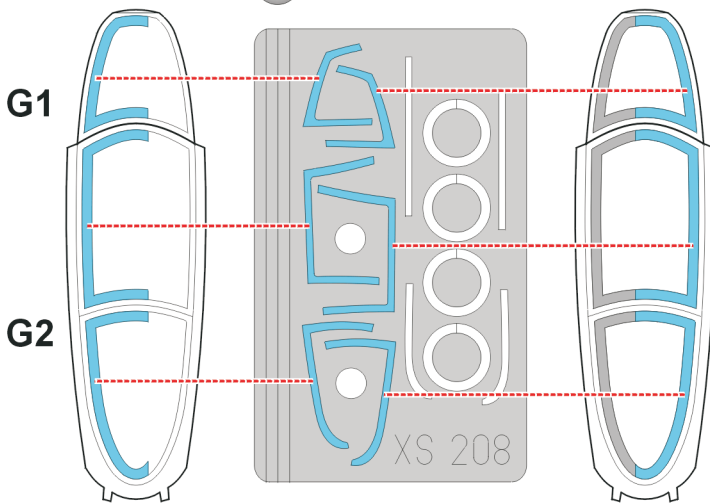

2.)

INTERIOR COLOR

3.)

CAMOUFLAGE COLOR

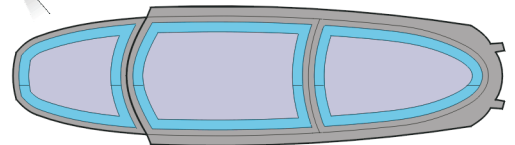

LIQUID MASK ■

4.)

REMOVE MASK

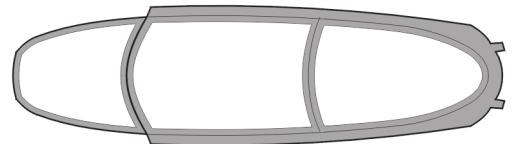

G1

G2

5.)

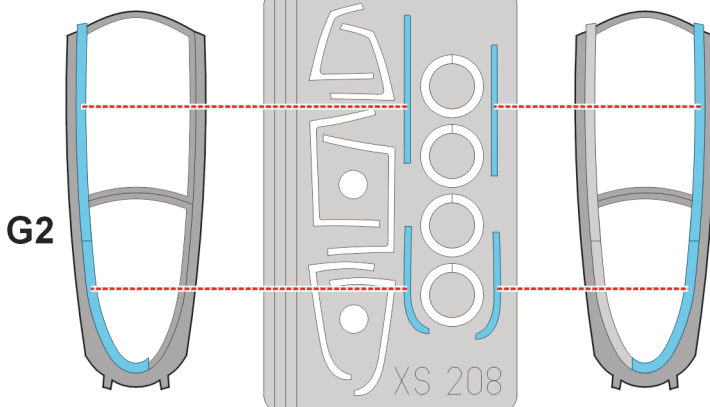

6.)

CAMOUFLAGE COLOR

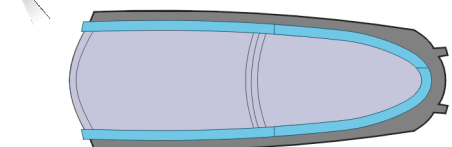

LIQUID MASK ■

7.)

REMOVE MASK



G2