

eduard
Express Mask

Tu-16

The die-cut mask for accurate canopy frame painting of the
Trumpeter 1/72 KIT

XS 111

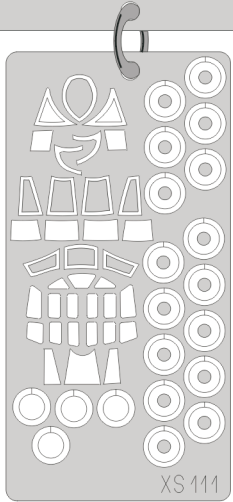

2x C1 15

LIQUID MASK

2x C1 14

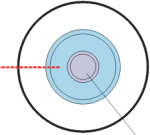
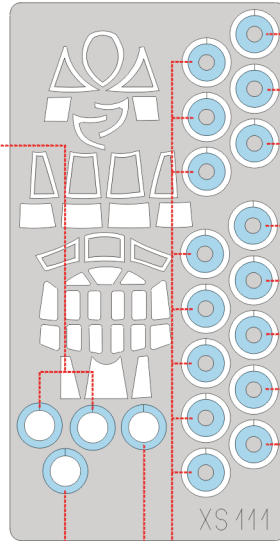

8x C1 26

LIQUID MASK

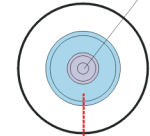

8x C1 27



2x C1 15

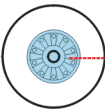

2x C1 14

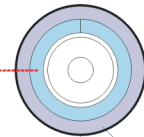
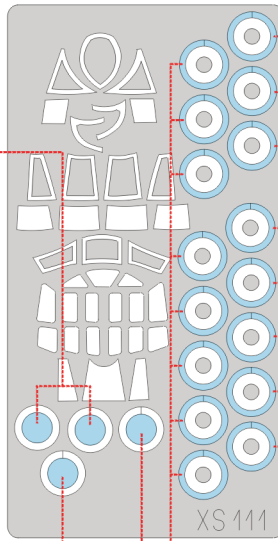
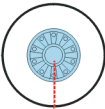

8x C1 26

LIQUID MASK

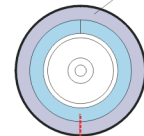

8x C1 27

1.)

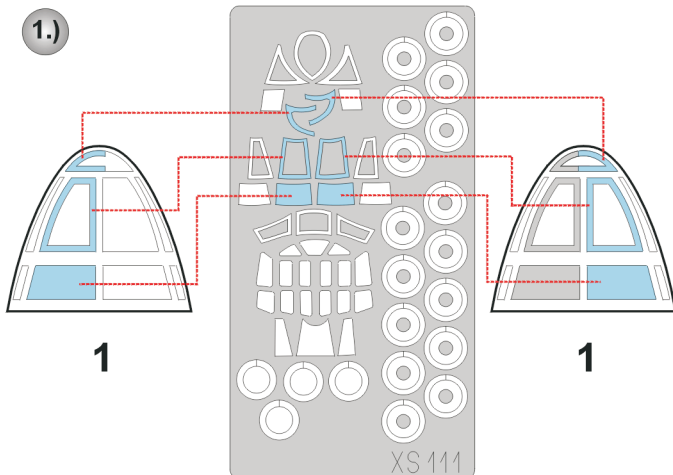

1

2.)

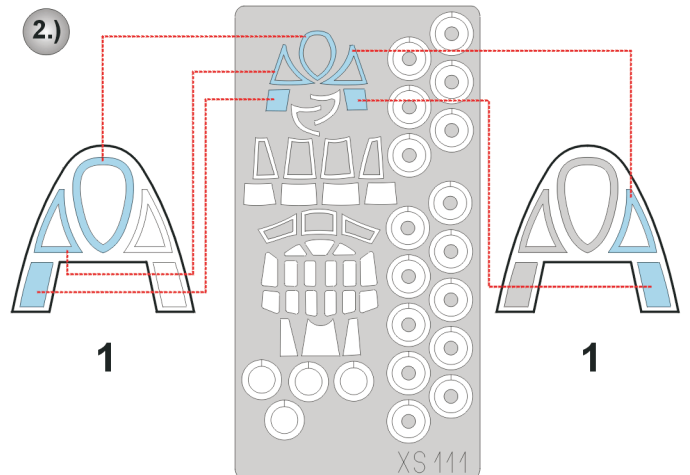

1

1

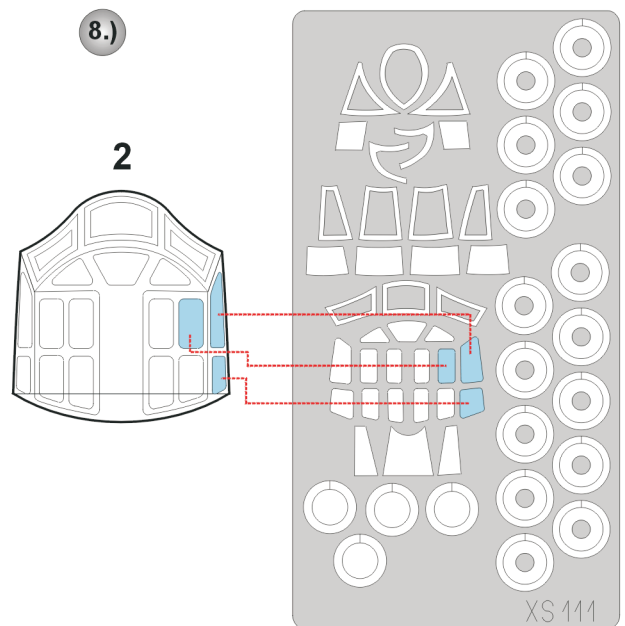
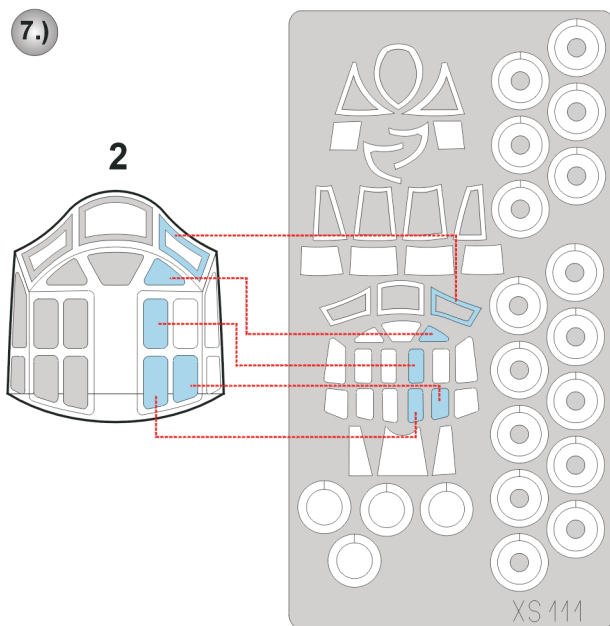
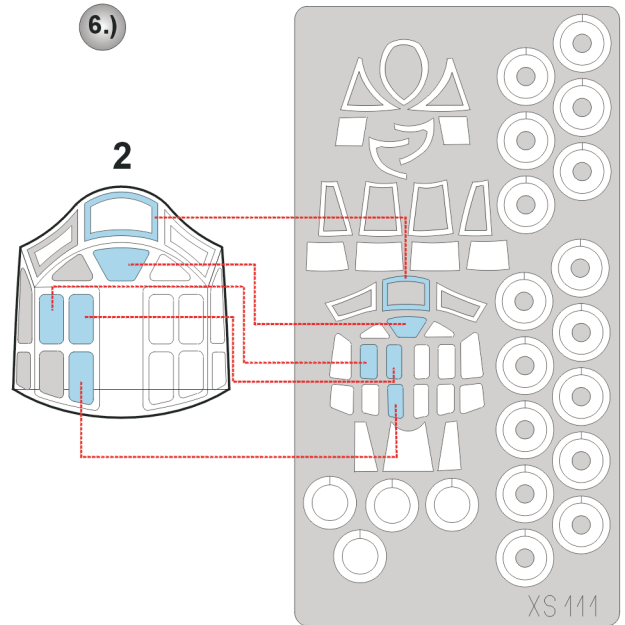
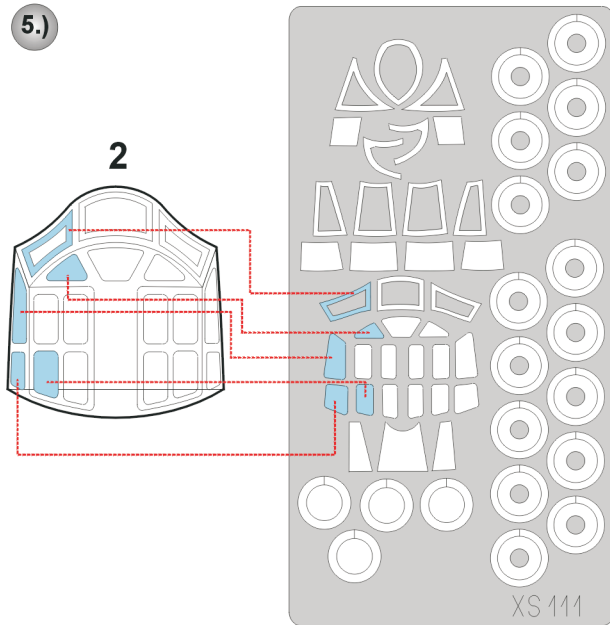
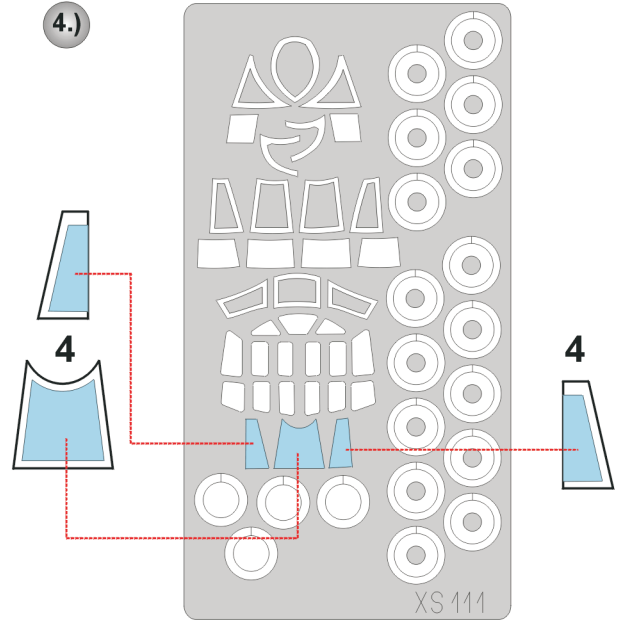
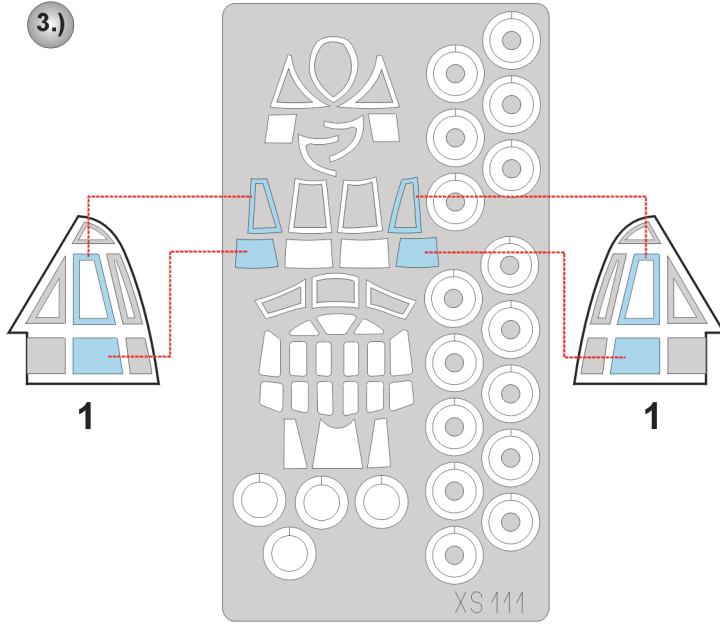

9.)



INTERIOR COLOR

LIQUID MASK

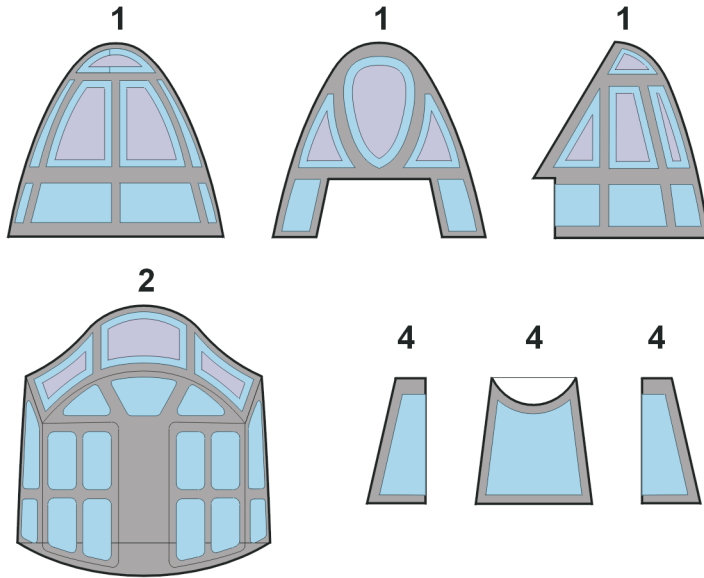

10.)



CAMOUFLAGE COLOR

LIQUID MASK

