

**eduard**  
**Express Mask**

**XF 542**

# F4F National Insignia red outline

FOR 1/48 KIT

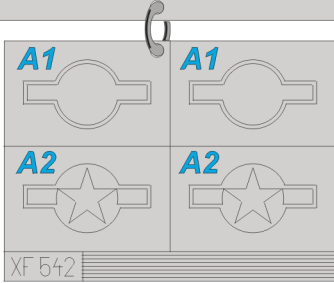

**2x**

### REFERENCES:

IN DETAIL & SCALE VOL.65  
John M. Elliott  
THE OFFICIAL MONOGRAM  
US NAVY & MARINE CORPS  
AIRCRAFT COLOR GUIDE  
(vol.2 1940-1949)

1.)

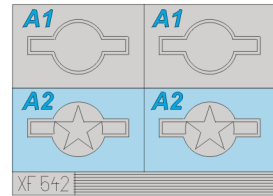
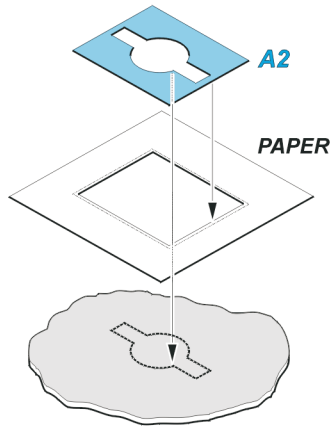

2.)

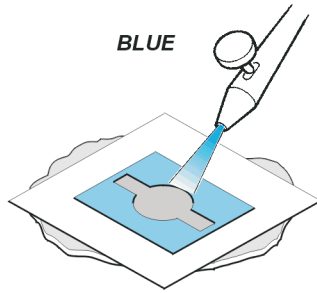

3.)

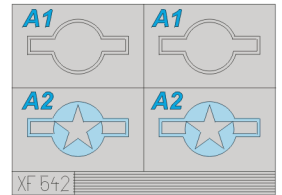
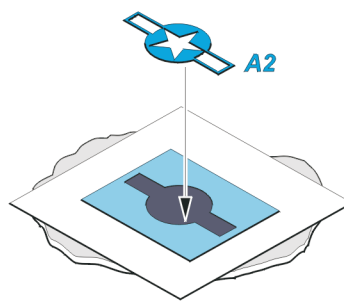

4.)

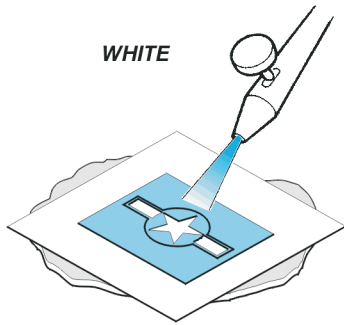

5.)

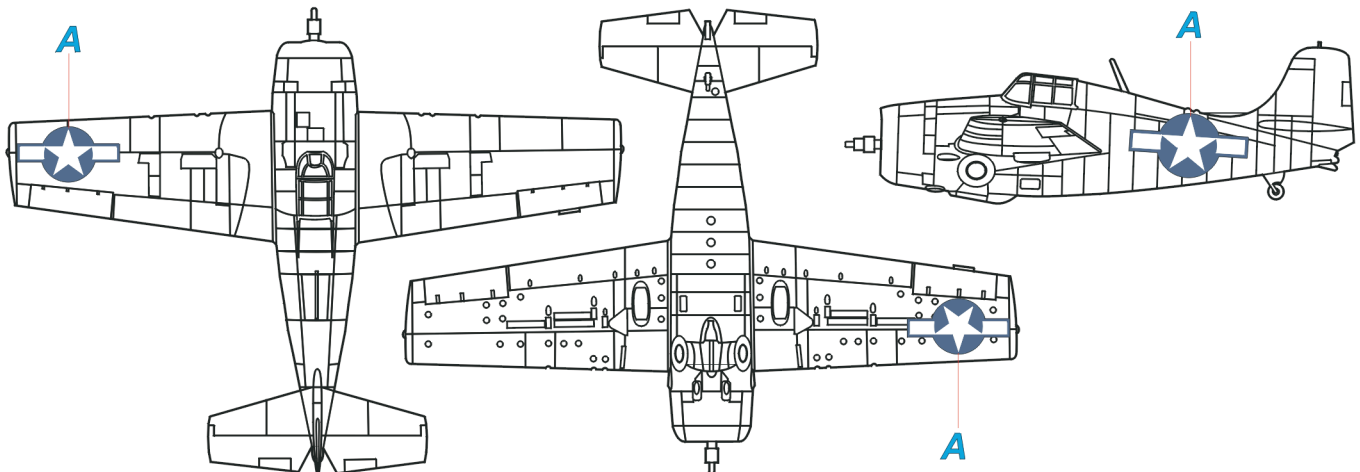
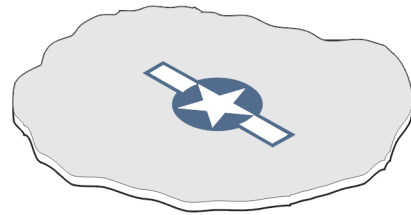

1.)

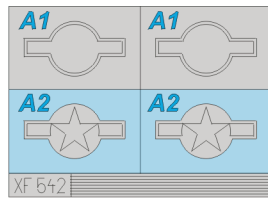
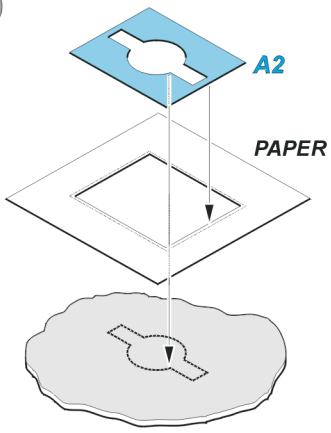

2.)

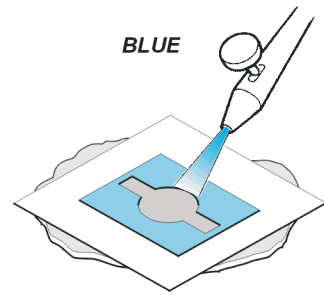

3.)

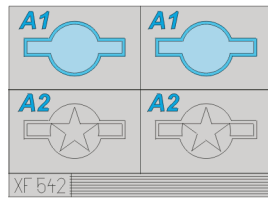
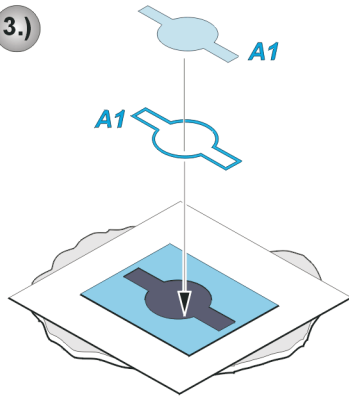

4.)

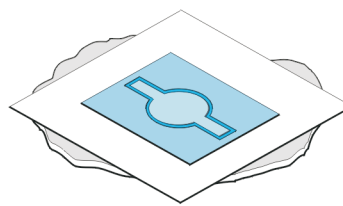

5.)

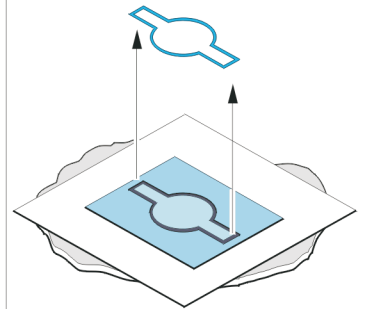

6.)

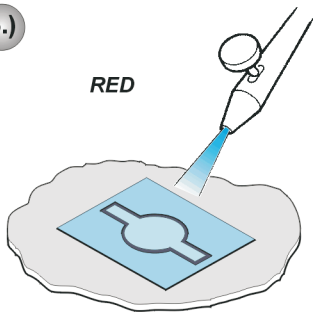

7.)

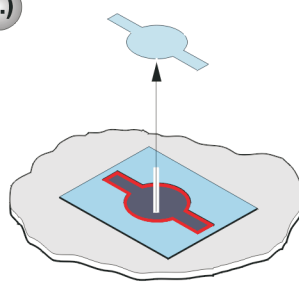

8.)

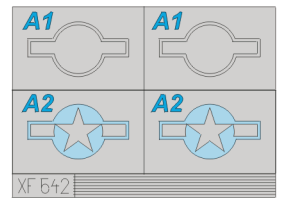
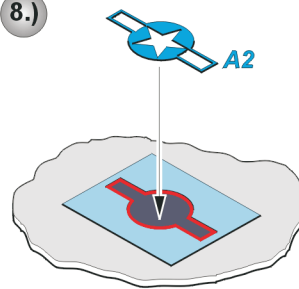

9.)

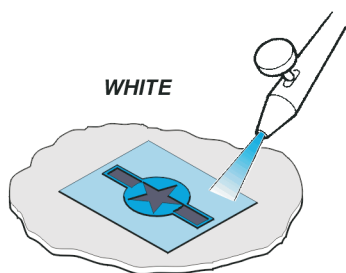

10.)

