

eduard
MASK

JX 072

Spitfire Mk.Vb 1/32

The die-cut mask for accurate canopy frame painting of the
Hasegawa scale 1/32 KIT

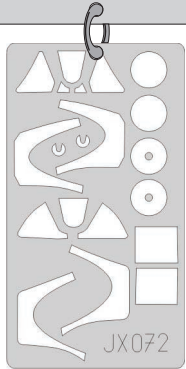

C21
LIQUID MASK

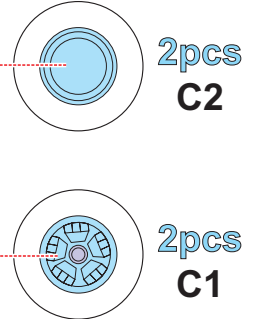
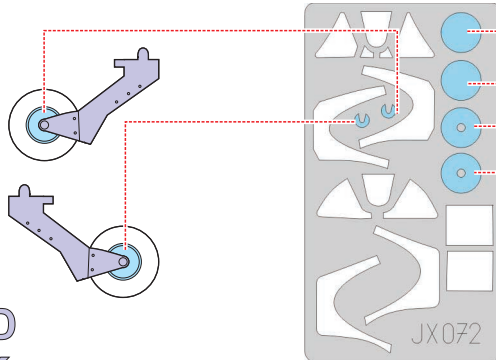

1.)

D1

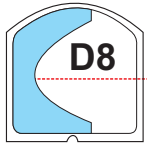

D8

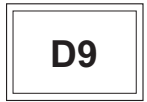

D9

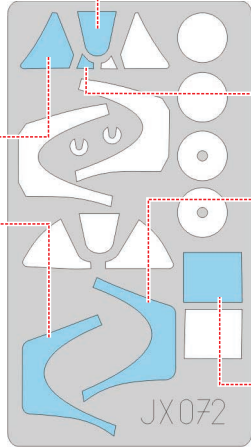

2.)

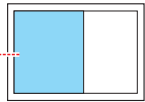
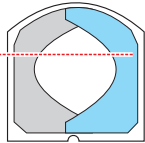
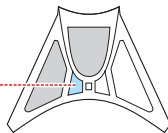

D1

D8

D9

3.)

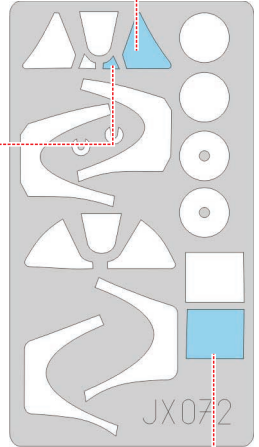
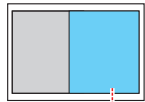
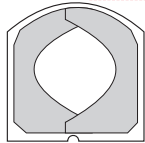
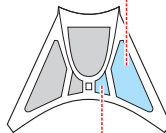

4.)

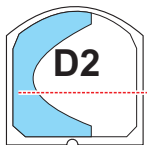

D2

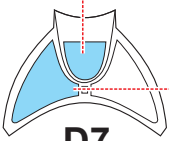

D7

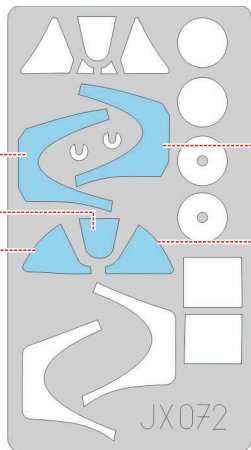

5.)

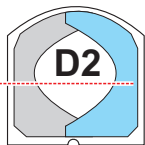

D2

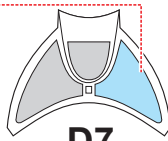

D7

6.)



INTERIOR COLOR

7.)



CAMOUFLAGE COLOR

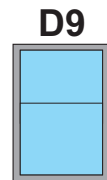

D9

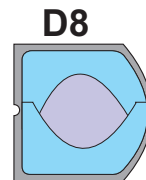

D8

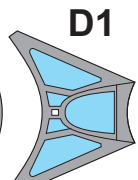

D1

LIQUID MASK

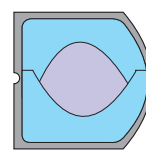

D2

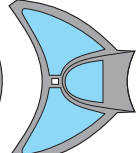

D7