









F-16D block 52+ interior S.A.



FE461

1/48 scale detail set for Kinetic kit • sada detailů pro model Kinetic 1/48



-  SYMMETRICAL ASSEMBLY
SYMETRICKÁ MONTÁŽ
-  REMOVE
ODSTRANIT
-  BEND
OHNOUT
-  REPLACE
NAHRADIT
-  GRIND
OBROUSIT
-  OPTION
VOLBA

 ORIGINAL KIT PARTS
PŮVODNÍ DÍLY STAVEBNICE

 PHOTO-ETCHED PARTS
LEPTANÉ DÍLY

 PARTS TO BE REMOVED
DÍLY K ODSTRANĚNÍ

 FILL
TMELIT

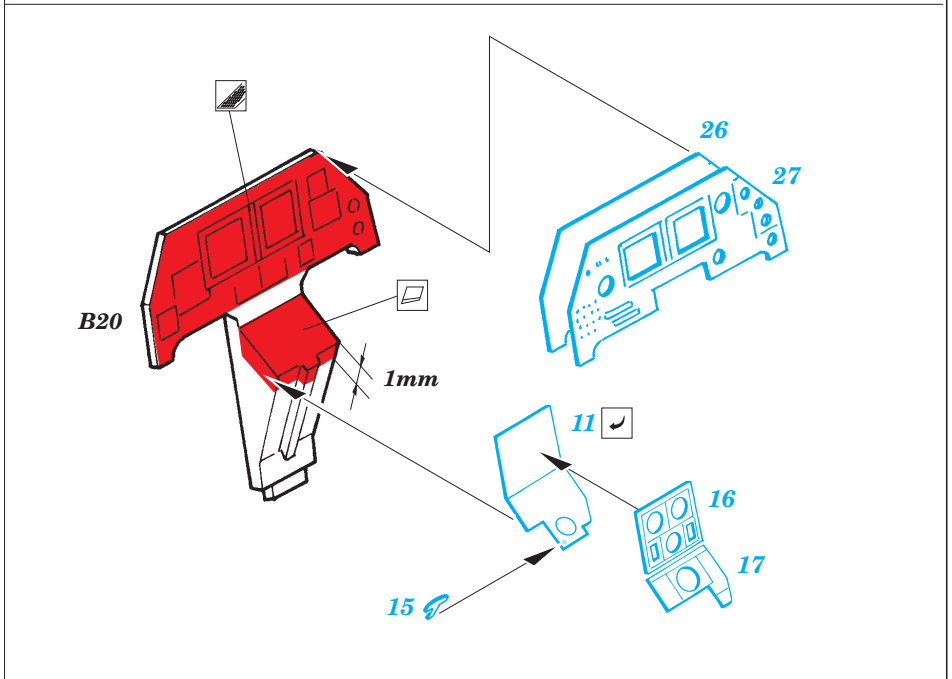
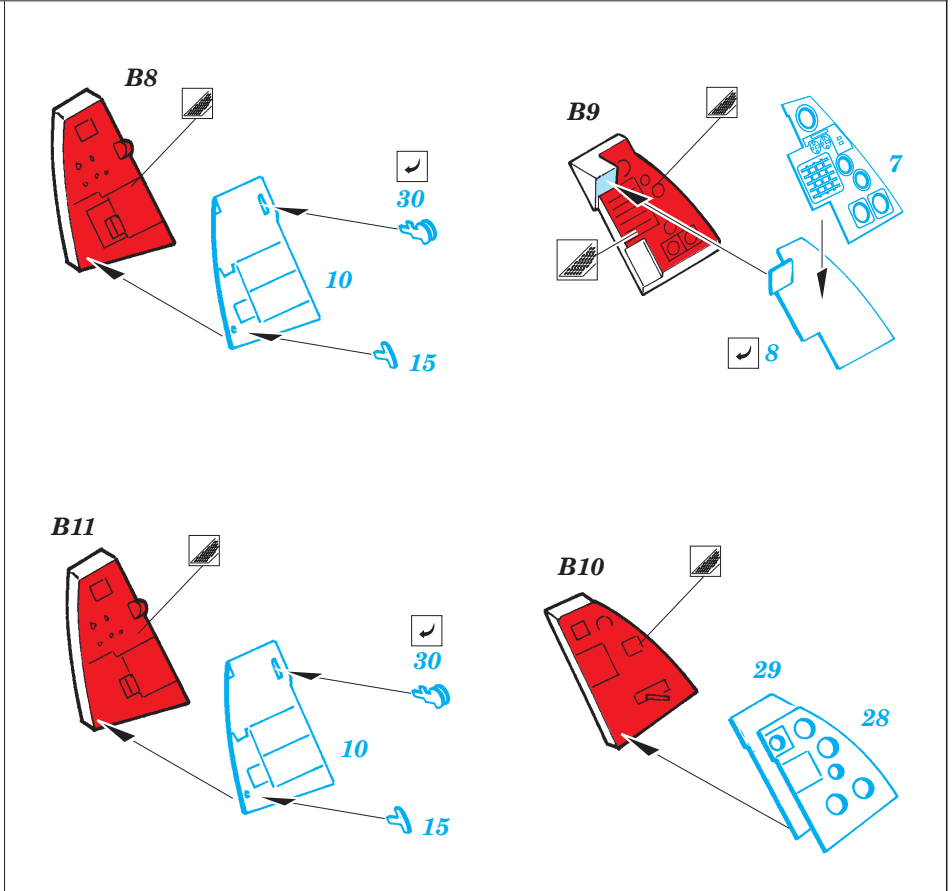
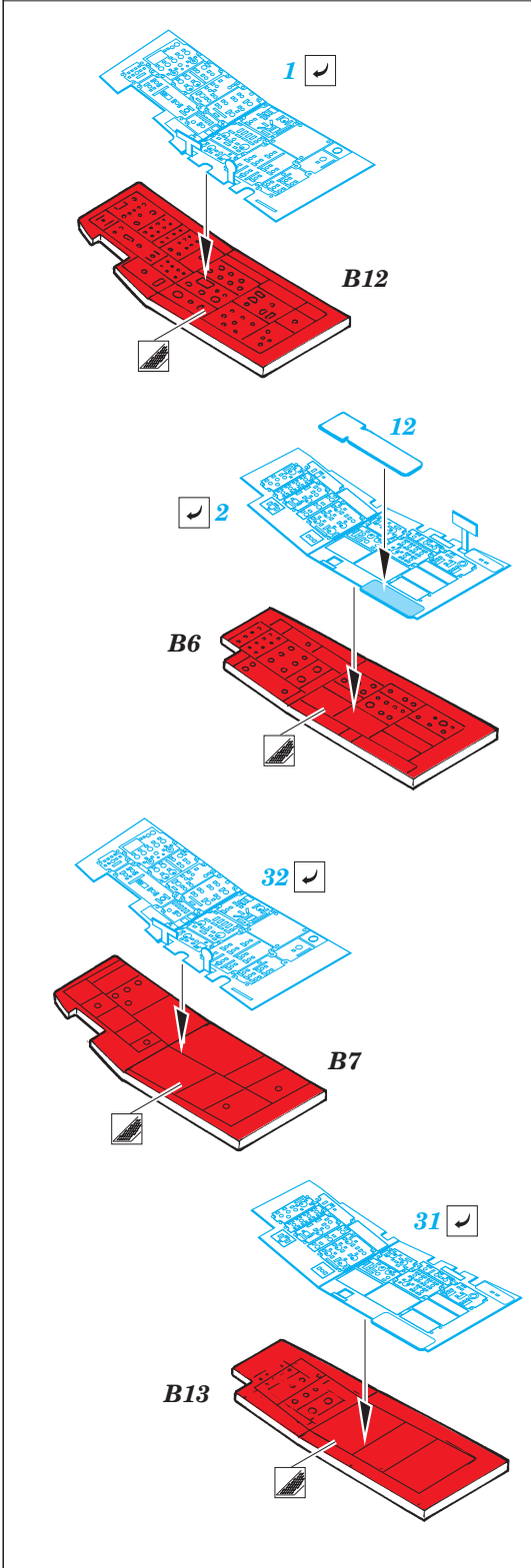

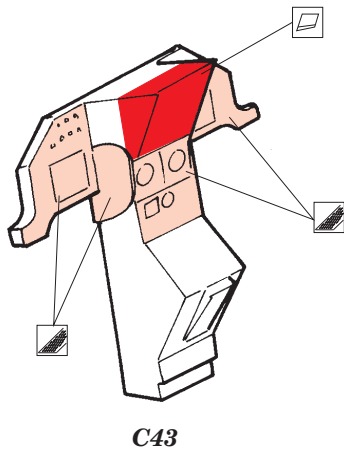

C43

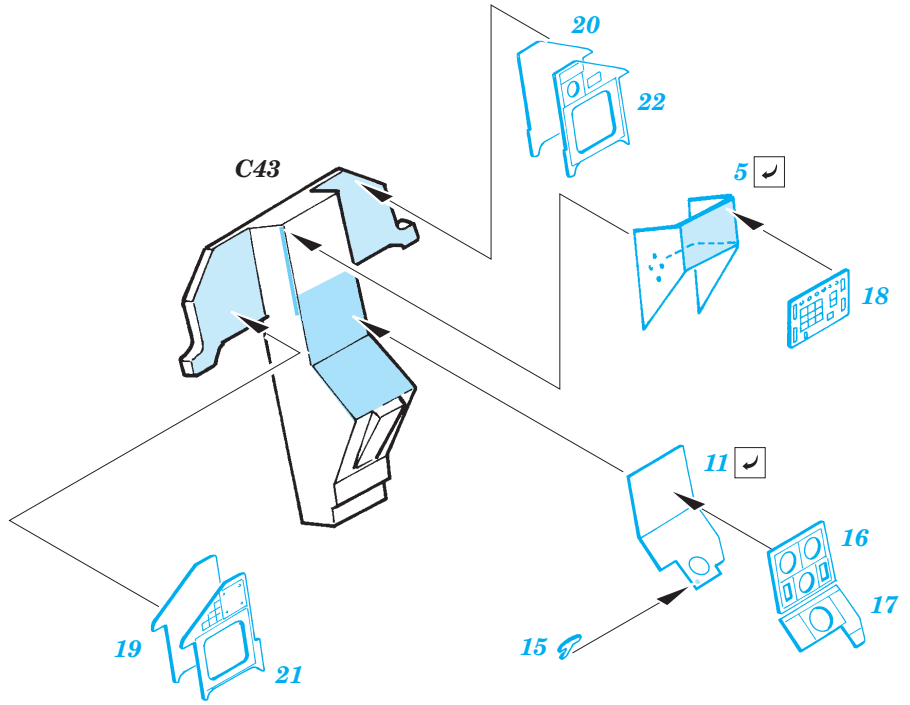

C43

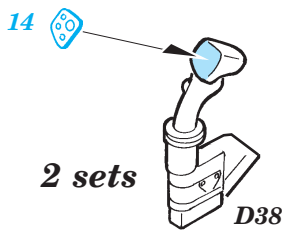

2 sets

D38

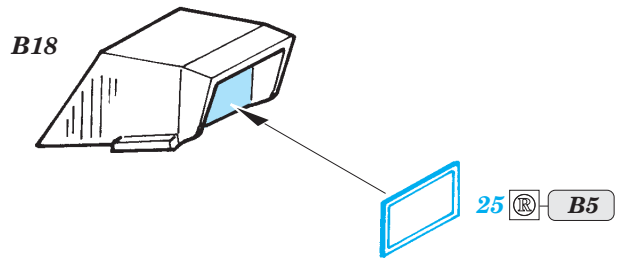

B18

25

B5

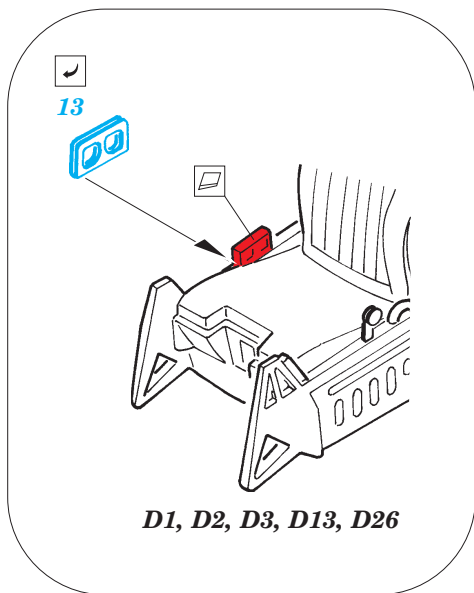

D1, D2, D3, D13, D26

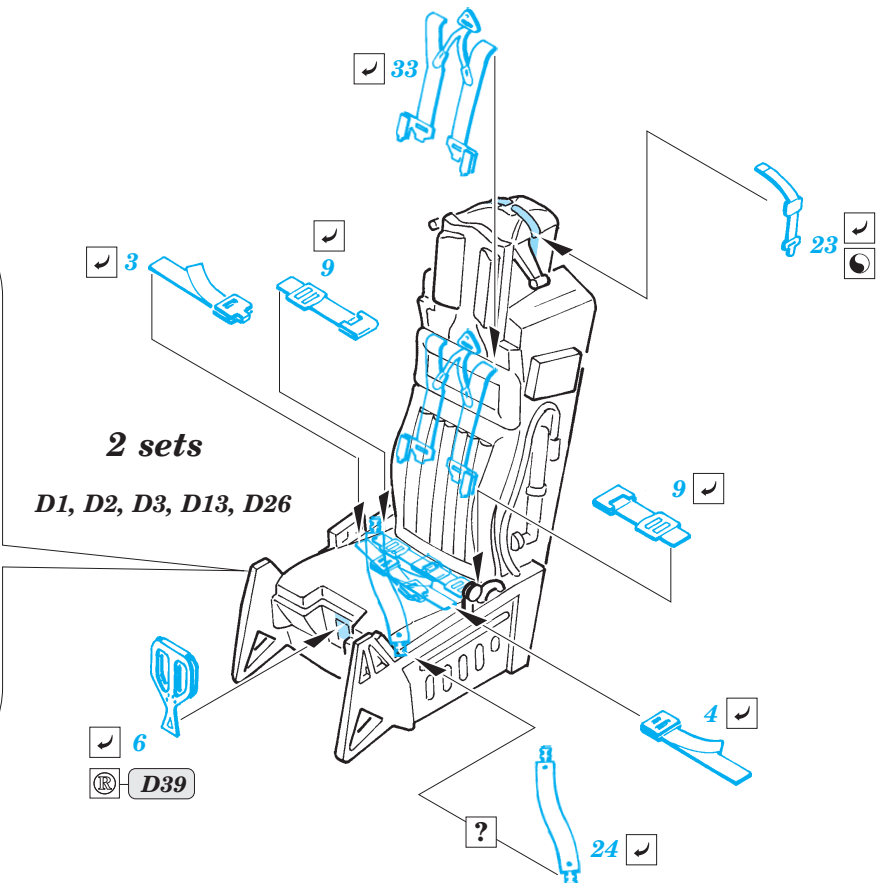

2 sets

D1, D2, D3, D13, D26

FE 461**F-16D interior block 52+ S.A.**

1/48 scale detail set for Kinetic kit • sada detailů pro model Kinetic 1/48

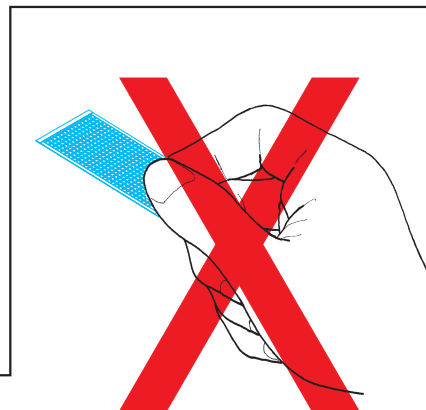
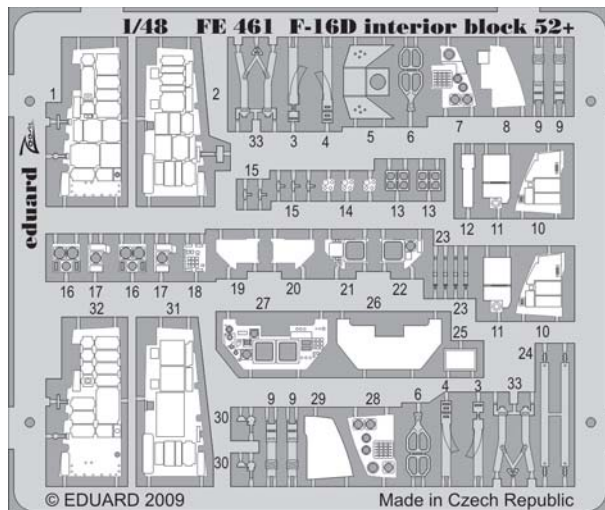

1. Separate the etched components from their frames on the protective paper. Removal from the paper is done only after separation of the parts from the frames.

1. Samolepicí díly oddělujte od rámečku na podkladovém papíře. Po oddělení je sejměte z krycího papíru.

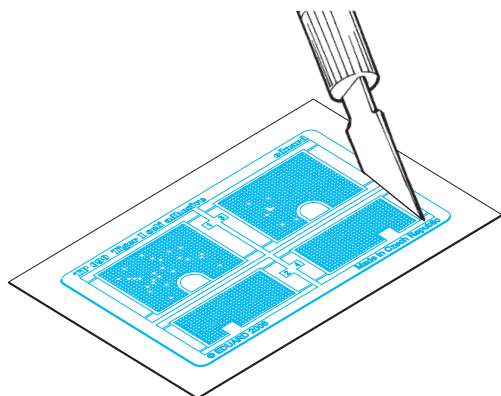

2. Do not inadvertently place etched components on an unwanted surface. Attempts to remove will result in damage to your part.

2. Nepokládejte samolepicí díly na volné plochy. Pokud je omylem přilepíte, při pokusu o odlepení dojde k poškození dílu.

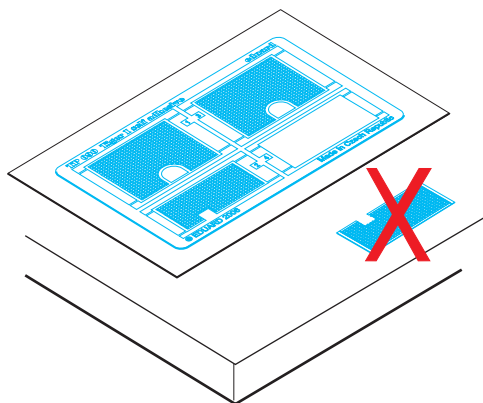

3. Do not touch the adhesive areas of the etched components.

3. Nesahejte na části dílů, na kterých je nanášeno lepidlo.

4. Hold the parts by the edges, or at areas free of adhesive.

4. Samolepicí díly berte za hrany nebo za části, na kterých není nanášené lepidlo.

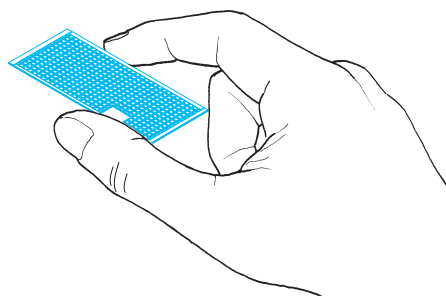

5. Lightly place the component in the desired location and position. Adjust as required. The component will be permanently affixed when pressed onto its intended location, its location can be adjusted.

5. Díl lehce položte do pozice, ve které má být nalepen. Upravte přesnou pozici a přimáčkněte. Díl dokonale přilne až po přimáčknutí, před přimáčknutím lze dílem opatrně manipulovat.

