









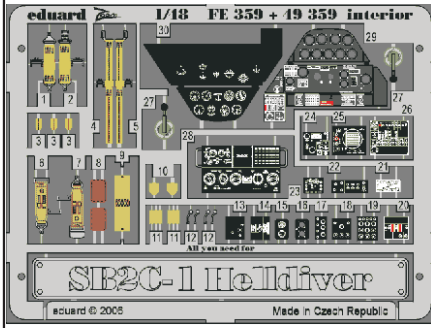

SB2C-1 Helldiver interior



1/48 scale detail set for **REVELL** kit • sada detailů pro model **REVELL** 1/48
MONOGRAM **ACCURATE MINIATURES**

FE359



-  APPLY EXPRESS MASK AND PAINT BEFORE GLUING
POUŽIT EXPRESS MASK NABARVIT PŘED SLEPENÍM
-  SYMMETRICAL ASSEMBLY
SYMETRICKÁ MONTÁŽ
-  REMOVE
ODSTRANIT
-  GRIND
OBROUSIT
-  DRILL HOLE
VRTAT OTVOR
-  BEND
OHNOUT
-  OPTION
VOLBA
-  REPLACE
NAHRADIT



ORIGINAL KIT PARTS
PŮVODNÍ DÍLY STAVEBNICE



PHOTO-ETCHED PARTS
LEPTANÉ DÍLY



PARTS TO BE REMOVED
DÍLY K ODSTRANĚNÍ



FILL
TMELIT

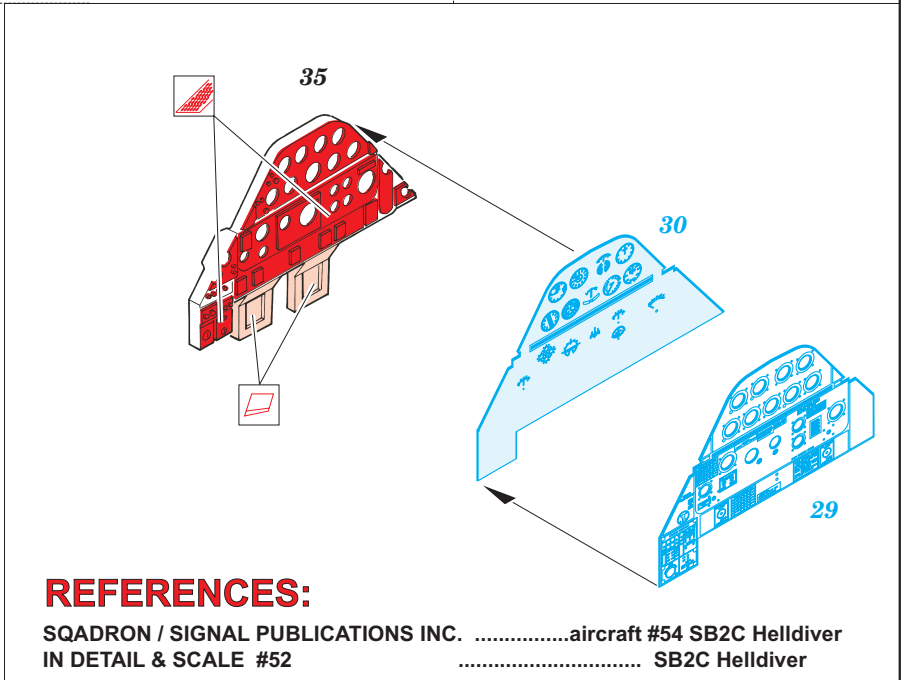
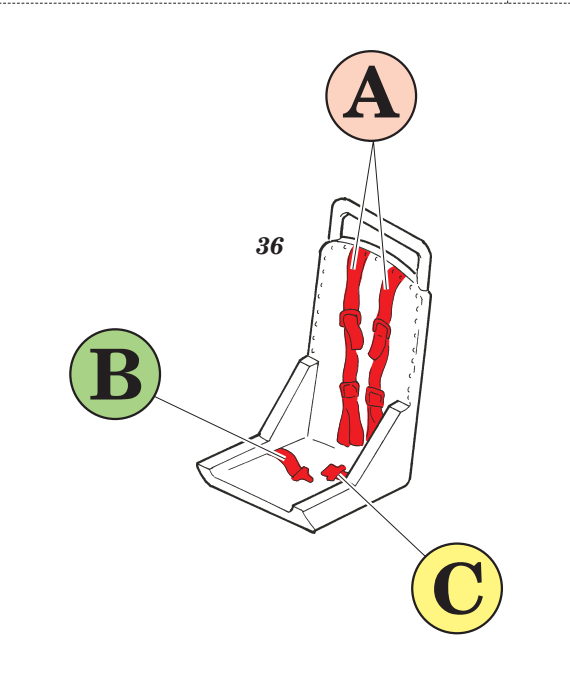
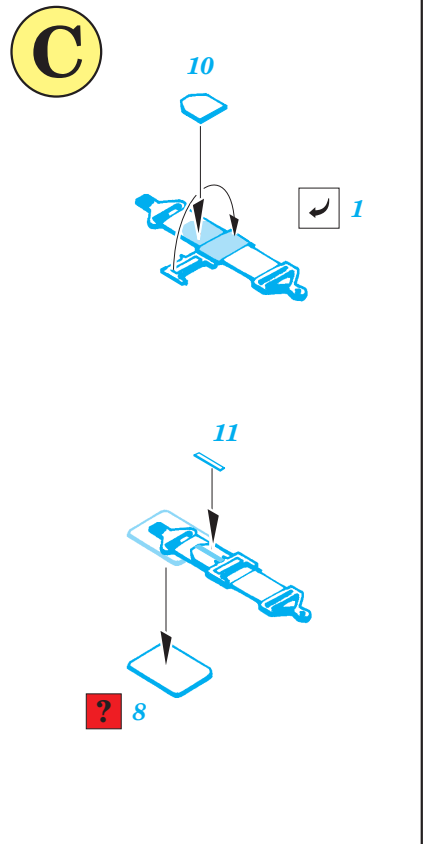
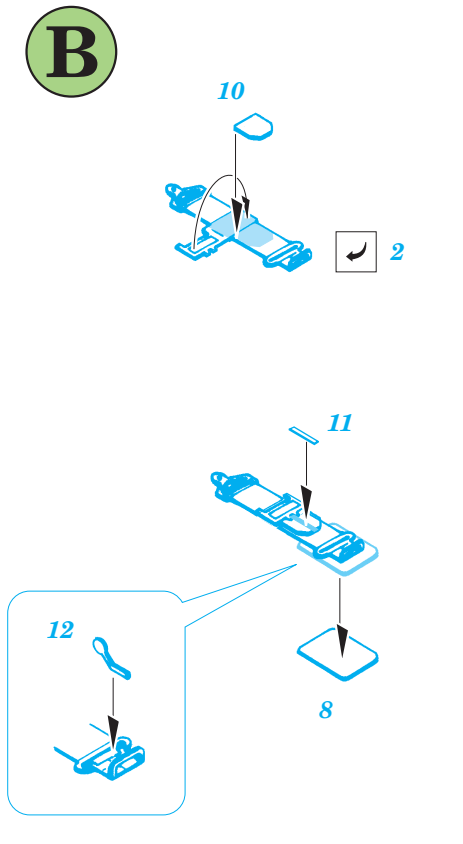
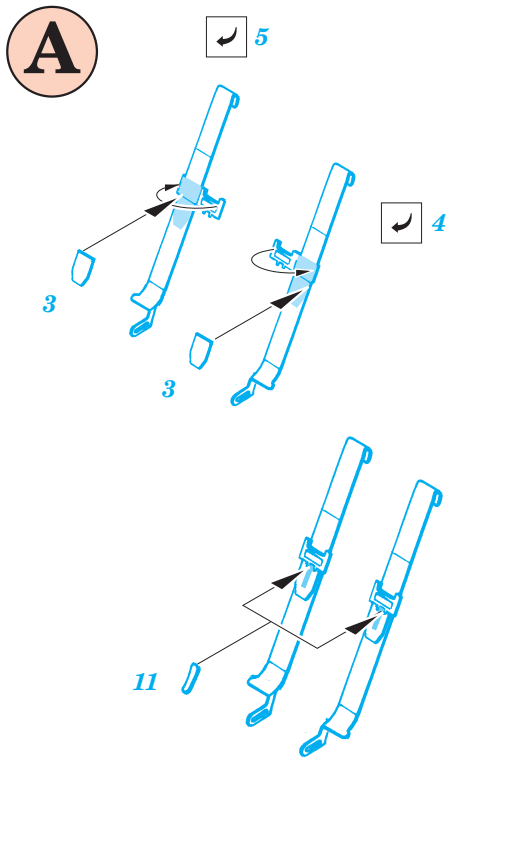

REFERENCES:

SQADRON / SIGNAL PUBLICATIONS INC.aircraft #54 SB2C Helldiver
 IN DETAIL & SCALE #52 SB2C Helldiver

