

INFORMATION FOR DISTRIBUTORS

JUNE 2024

Dear friends,
I would like to inform you about new releases coming up in June 2024.

THE KITS

The new kits for June were also partly chosen in connection with the upcoming 80th anniversary of the Allied invasion of Normandy as part of Operation Overlord.

The primary June new release will be the MARAUDER kit, issued in the Limited Edition at 1/72nd scale. It is based on Hasegawa mouldings and will encompass the B-26F and G versions. Alongside the customary masks and pre-painted photo-etched parts, it will also incorporate resin undercarriage wheels. The decal sheet will enable the construction of one of eight machines from the European and Mediterranean theatre of operations.

Another new addition to the Weekend series will be a 1/48th scale Spitfire Mk.Vb kit, focusing on the Spitfires deployed during Operation Overlord. While Spitfires IX played a major role in the Royal Air Force during the Normandy invasion, Spitfires V of various versions also participated in this historic operation. Represented will be the US Navy Cruiser Scouting Squadron Seven (VCS-7), operating over the battlefield in the role of artillery spotters for the warships. Additionally, No. 401 Squadron RAF with F/O Rick R. Richards' machine, the legendary Cdt. J.M. Accart of the French No. 345 Squadron, and the selection is rounded off by No. 64 Squadron with F/Lt Tony Cooper's machine.

In the June release of the ProfiPACK edition, we will introduce our new Bf 109G-6 kit in 1/72 scale. This kit enables the construction of a scale model with a standard canopy and an older type of rudder. It offers the option to build one of six machines. The first is the legendary aircraft with the red tulip on the nose, flown by Major Hermann Graf, commander of Jagdgeschwader 50. Non-standard undercarriage covers will be included in the photo-etched set in the kit for this decal variant. The other machines were flown by Oblt. Weissenberger of II./JG 5 in winter camouflage on the Eastern Front, as well as the commanders Hptm. Hackl of III./JG 11, Maj. Franzisket of I./JG 27, Lt. Alfred Hammer of 6./JG 53, and Oblt. Brock of 8./JG 54 „Grünherz“.

In addition, the ProfiPACK reissue will feature a 1/48 scale kit of the Fw 190A-2 fighter aircraft.

The 80th anniversary of Operation Overlord presents another exceptional trading opportunity. In addition to the new releases mentioned above, we offer several other Invasion-themed items in our kit selection. Consider taking advantage of them during this spring and summer, when the anniversary of the Invasion will be in the spotlight, not only for modelers. Below is a list

of Operation Overlord-themed kits:

8281 Spitfire Mk. IXc late version 1/48 ProfiPACK

82122 Tempest Mk. V series 2 1/48 ProfiPACK

84172 P-51D-5 1/48 Weekend

84183 Spitfire Mk.IXc 1/48 Weekend

84195 Tempest Mk. V Series 1 1/48 Weekend

7466 Spitfire Mk. IXc 1/72 Weekend

May new release: 11181: D-Day Mustangs; P-51B Mustang Dual Combo

P-51D MUSTANG - ROYAL CLASS IN 1/72 SCALE

In the next few days, we will provide you with information about the upcoming new tool P-51D Mustang in 1/72 scale. Similar to the 1/48th scale P-51B, we will release the 1/72nd scale P-51D first in a revived Royal Class (Dual Combo) edition, which will be available for pre-order only. In August 2024, the 1/72 P-51D will be released as an additional item in a Limited edition, also as a Dual Combo. This kit will also be available as a stock item.

BRASSIN

Among the most interesting June new products made by direct 3D printing are the engines for the Beaufort Mk.I in 1/48 scale from our Ukrainian colleagues at ICM. These engines are very easy to work with and pleasant to assemble.

Another intriguing new item is a parachute for the F-4E Phantom II in 1/48 scale by Meng. We've dedicated significant time to developing this item, and after careful consideration for the stability of the model, we've opted for the form of the parachute that is partially deployed and gently touches the airfield surface. It's a visually striking item that has generated considerable interest from customers during presentations at model shows and competitions. I highly recommend mentioning it in your promotional materials.

The main theme of the June Brassin series will feature the 1/48 scale P-51B/C Mustang by Eduard. June's offerings will include several smaller sets, encompassing three types of wheels, two types of propellers, 108-gallon drop tanks, and bazookas. Additionally, larger sets will follow in July and August, such as the engine, cockpit, and gun bays.

I'd also like to mention the 1/48 scale cockpit for the F-35B by Tamiya. Furthermore, we will release two more BIGSIN sets for kits from this company in June: one set containing both engines for the P-38J Lightning (1/48) and another featuring a weapons set for the F-35A (1/72). In the LööK series, we will introduce four 1/48 scale sets: the F4U-1A Corsair (Magic Factory), P-47D-30 (Miniart), I-16 Type 24 (Eduard), and FM-1 Wildcat (Tamiya). As for the LööKplus extended sets, they will comprise settings for the Gannet AS.1/AS.4 (1/48, Airfix), Bf 109G-2, and Bf 109G-4 (1/72, Eduard).

ACCESSORY SETS - PHOTO-ETCHED PARTS, MASK AND DECALS

In 1/32 scale, for the A-20J/K and Boston Mk.IV kits, we will release photo-etched sets for the cockpit&nose interior, bomb bay, wheel wells, along with the usual seat belt sets and Zoom sets.

For the 1/350 scale USS Sangamon CVE-26 escort aircraft carrier kit by Trumpeter, we will offer a second photo-etched set in June.

In the BIG ED line, sets for the F-35B (1/48, Tamiya), Gannet AS.1 and AS.4 (1/48, Airfix), and Hurricane Mk.IIb (1/48, Arma Hobby) sets will be available for June.

Additionally, the photo-etched set, seat belt set, and Zoom set will be released in an unusual 1/35 scale for the Nakajima B5N Kate bomber kit from Border Model.

Finally, we will release the Zoom, the seat belt set, as well as the classic pre-painted photo-etched set in June for the TBD-1 Devastator kit in 1/48 scale from Hobby Boss.

A Zoom set, seat belts, and a larger photo-etched set for cockpit and engine details will be released for the 1/48 scale B-24J Liberator kit by Hobby Boss.

A separate set of 1/72 scale etchings will be prepared for the interior and exterior of the SM.79 Sparviero bomber by Italeri, and we will also produce a Zoom set for it.

In the Space 3D decal series, we will release a 1/35 scale set for the Japanese B5N Kate bomber by Border Model, and 1/32 scale sets for the A-20J/K and Boston Mk.IV (HKM). In 1/48 scale, there are sets for the B-24J Liberator and TBD-1 (Hobby Boss), Fw 190A-2 (Eduard), and of course the B-26B Marauder (ICM). In 1/72 scale, there will be sets for the iconic SM.79 bomber Sparviero (Italeri) and B-26 Marauder (Hasegawa/Eduard). Flags will be available in 1/350 scale for US Navy ship models. The decals can be shaped well on the model and are printed as double-sided.

In the Eddie the Riveter 3D decal series, we have double round rivets in 1/32, 1/48, and 1/72 scale for June.

SHIPPING OF MAY ITEMS AND PRE-ORDERS OF JUNE NEW RELEASES

As is customary each month, I kindly request that you submit your **pre-orders for the June releases, preferably by Tuesday, April 30, 2024**. Based on your pre-orders, we will determine the quantity of items to produce. Please note that **if we do not receive your pre-order, we cannot guarantee the availability of all items** for your future orders, particularly for LIMITED series items. Shipments of the May new releases will start on Wednesday 17 April.

Should you require assistance with marketing materials, please do not hesitate to contact me directly.

Thank you for your attention and continued support!
Jan Bobek

Product previews are subject of change.

Instruction sheets,
more pictures and information
can be found on www.eduard.com

This leaflet can be downloaded from on www.eduard.com

eduard

PLASTIC KITS

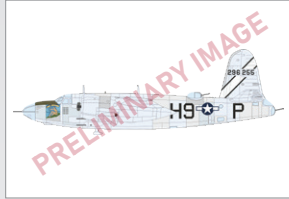

2146 **MARAUDER**
1/72 Limited

DETAIL



84200 **Spitfire Mk.Vb**
OVERLORD 1/48 Weekend

DETAIL



70159 **Bf 109G-6**
1/72 ProfiPACK

DETAIL



82146 **Fw 190A-2**
1/48 ProfiPACK **Re-release**

DETAIL

MASKS

JX324	A-20J/K	1/32	HKM
JX325	A-20J/K TFace	1/32	HKM
JX326	B5N2 TFace	1/32	Border Model
EX1041	B-24J	1/48	Hobby Boss
EX1042	B-24J TFace	1/48	Hobby Boss
EX1043	B-24J US national insignia	1/48	Hobby Boss
EX1044	B-26B Marauder	1/48	ICM
EX1045	B-26B Marauder TFace	1/48	ICM
EX1046	B-26B Marauder national insignia	1/48	ICM
EX1047	TBD-1 TFace	1/48	Hobby Boss

SPACE

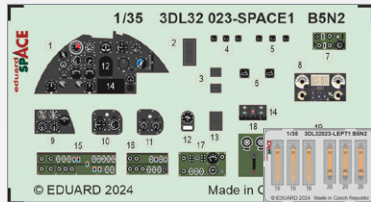

3DL32023 **B5N2 SPACE**
1/35 Border Model
(2 parts)

DETAIL

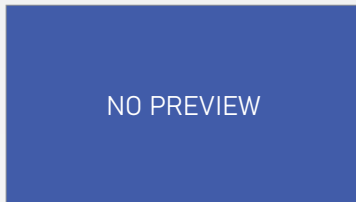

3DL32024 **A-20J/K SPACE**
1/32 HKM
(2 parts)

DETAIL

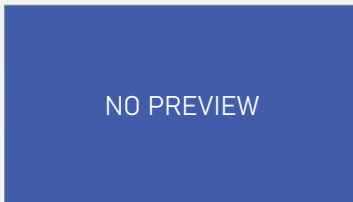

3DL32025 **Boston Mk.IV SPACE**
1/32 HKM
(2 parts)

DETAIL

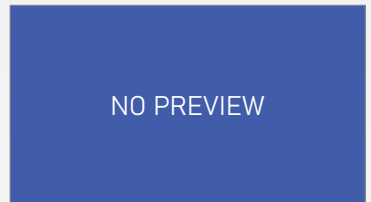

3DL48180 **B-24J SPACE**
1/48 Hobby Boss
(2 parts)

DETAIL



3DL48181 **TBD-1 SPACE**
1/48 Hobby Boss
(2 parts)

DETAIL



3DL48182 **Fw 190A-2 SPACE**
1/48 Eduard
(2 parts)

DETAIL

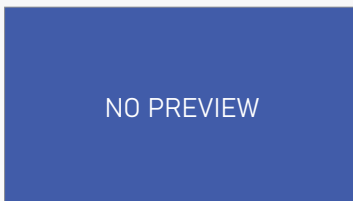

3DL48183 **B-26B Marauder SPACE**
1/48 ICM
(2 parts)

DETAIL

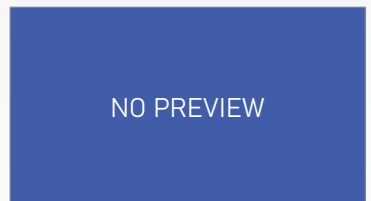

3DL72032 **SM.79 SPACE**
1/72 Italeri
(2 parts)

DETAIL

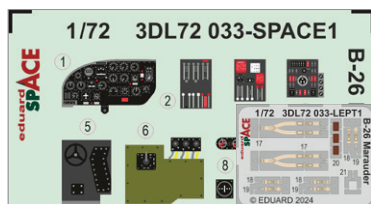

3DL72033 **B-26 Marauder SPACE**
1/72 Eduard
(2 parts)

DETAIL



3DL53014 **US Navy WW2 ensign flag**
for CVL, CVE, CL & DD SPACE 1/350
(1 part)

DETAIL

PHOTO-ETCHED SETS

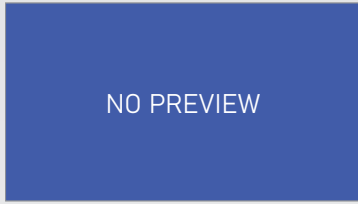

53310 USS Sangamon CVE-26 island
1/350 Trumeter
(1 part)

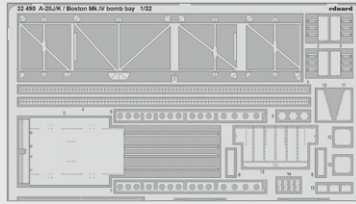

32490 A-20J/K / Boston Mk.IV bomb
bay 1/32 HKM
(1 part)

DETAIL

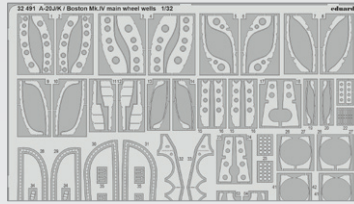

32491 A-20J/K / Boston Mk.IV main
wheel well 1/32 HKM
(1 part)

DETAIL

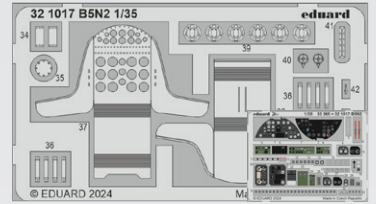

321017 B5N2
1/35 Border Model
(2 parts)

DETAIL

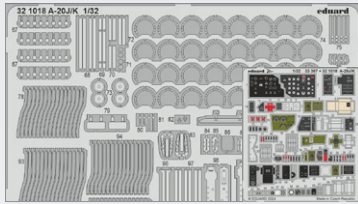

321018 A-20J/K
1/32 HKM
(2 parts)

DETAIL

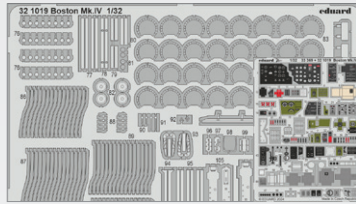

321019 Boston Mk.IV
1/32 HKM
(2 parts)

DETAIL

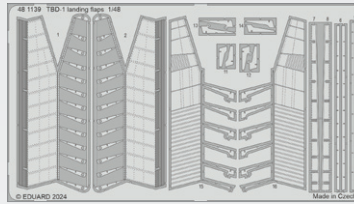

481139 TBD-1 landing flaps
1/48 Hobby Boss
(1 part)

DETAIL

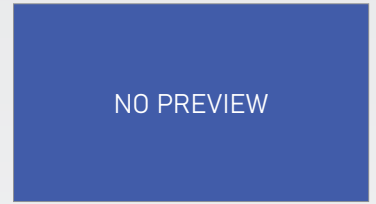

491450 B-24J cockpit & engines
1/48 Hobby Boss
(2 parts)

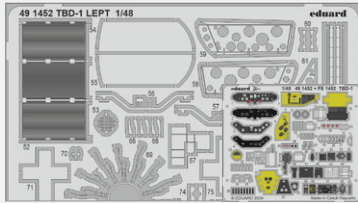

491452 TBD-1
1/48 Hobby Boss
(2 parts)

DETAIL

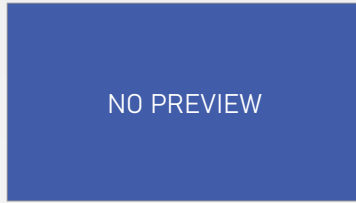

491454 B-26B Marauder cockpit
& nose interior 1/48 ICM
(2 parts)

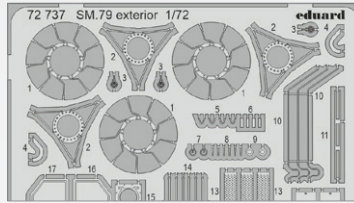

72737 SM.79 exterior
1/72 Italeri
(1 part)

DETAIL

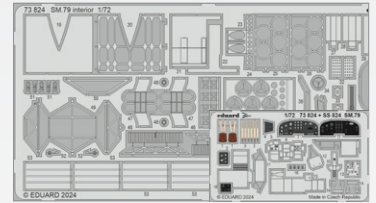

73824 SM.79 interior
1/72 Italeri
(2 parts)

DETAIL

PHOTO-ETCHED SETS

ZOOM

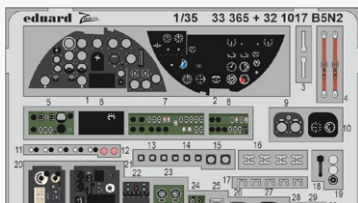

33365 B5N2
1/35 Border Model
(1 part)

DETAIL

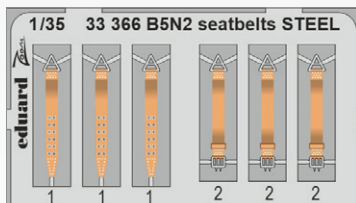

33366 B5N2 seatbelts STEEL
1/35 Border Model
(1 part)

DETAIL

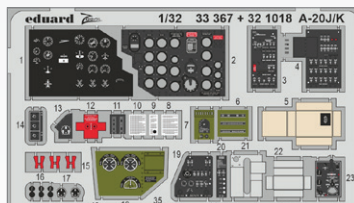

33367 A-20J/K
1/32 HKM
(1 part)

DETAIL

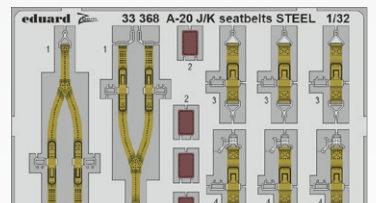

33368 A-20J/K seatbelts STEEL
1/32 HKM
(1 part)

DETAIL

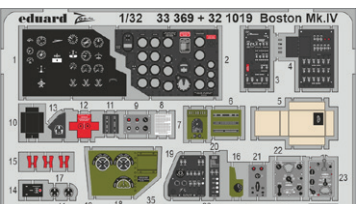

33369 Boston Mk.IV
1/32 HKM
(1 part)

DETAIL

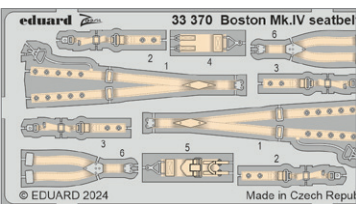

33370 Boston Mk.IV seatbelts STEEL
1/32 HKM
(1 part)

DETAIL

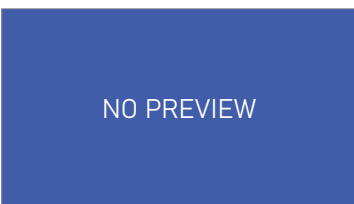

FE1450 B-24J
1/48 Hobby Boss
(1 part)

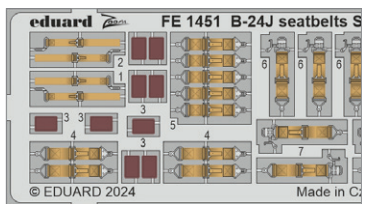

FE1451 B-24J seatbelts STEEL
1/48 Hobby Boss
(1 part)

DETAIL

PHOTO-ETCHED SETS

ZOOM

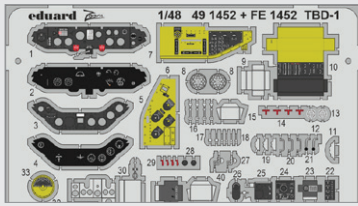

FE1452 TBD-1
1/48 Hobby Boss
(1 part)

DETAIL

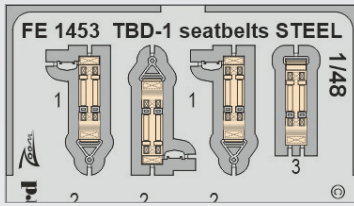

FE1453 TBD-1 seatbelts STEEL
1/48 Hobby Boss
(1 part)

DETAIL

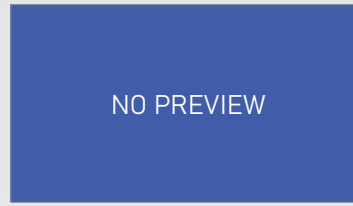

FE1454 B-26B Marauder
1/48 ICM
(1 part)

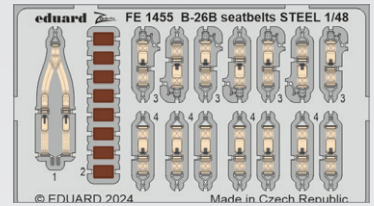

FE1455 B-26B Marauder seatbelts
STEEL 1/48 ICM
(1 part)

DETAIL

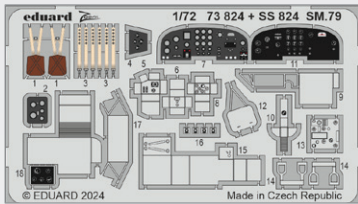

SS824 SM.79
1/72 Italeri
(1 part)

DETAIL

BIG ED SETS

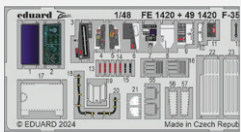

BIG49406 F-35B
1/48 Tamiya

DETAIL



BIG49407 Gannet AS.1
1/48 Airfix

DETAIL



BIG49408 Gannet AS.4
1/48 Airfix

DETAIL

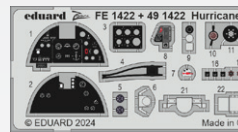

BIG49409 Hurricane
Mk.IIb 1/48 Arma Hobby

DETAIL

EDDIE THE RIVETER

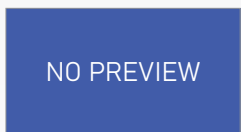

ER32006 Double radial
rows 1/32

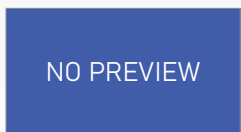

ER48011 Double radial
rows 1/48

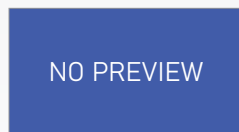

ER72006 Double radial
rows 1/72

BRASSIN



644264 F4U-1A LööK
1/48 Magic Factory

DETAIL



644269 P-47D-30 LööK
1/48 MINIART

DETAIL



644270 I-16 Type 24 LööK
1/48 Eduard

DETAIL

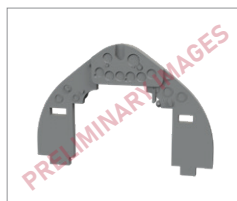

644271 FM-1 LööK
1/48 Tamiya

DETAIL

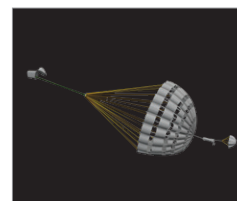

648910 F-4E parachute
PRINT 1/48 Meng

DETAIL



648983 Beaufort Mk.I
engines PRINT 1/48 ICM

DETAIL

BRASSIN

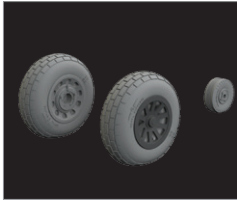

648989 P-51B/C wheels block tread 1/48 Eduard

DETAIL



648990 P-51B/C wheels diamond tread 2 1/48 Eduard

DETAIL



648991 P-51B/C wheels block tread 2 1/48 Eduard

DETAIL

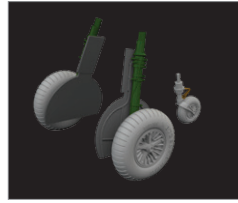

648998 Bf 108 wheels spoked 1/48 Eduard

DETAIL

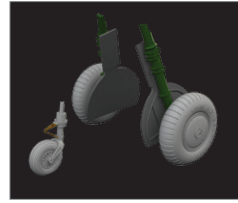

648999 Bf 108 wheels 1/48 Eduard

DETAIL



6481000 F-35B cockpit **PRINT** 1/48 Tamiya

DETAIL

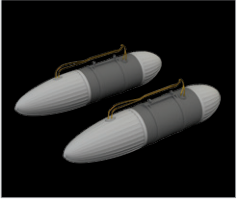

6481001 P-51B/C 108gal drop tanks **PRINT** 1/48 Eduard

DETAIL

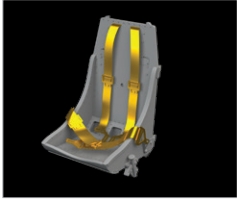

6481003 P-51B/C seat Type 2 **PRINT** 1/48 Eduard

DETAIL

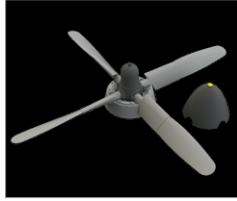

6481006 P-51B/C Hamilton Standard propeller 1/48 Eduard

DETAIL

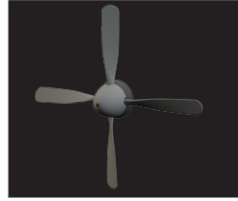

6481007 P-51B/C Hamilton Standard propeller uncuffed 1/48 Eduard

DETAIL

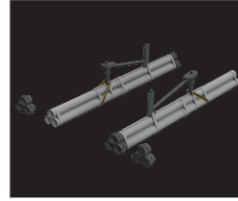

6481008 P-51B/C bazooka rocket launcher 1/48 Eduard

DETAIL

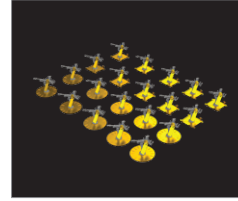

653019 IJN Type 96 25mm AA gun (single) **PRINT** 1/350

DETAIL

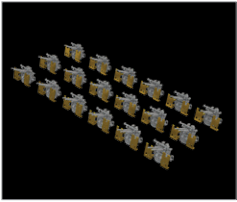

653020 IJN Type 96 25mm AA gun (double) **PRINT** 1/350

DETAIL

LööKplus

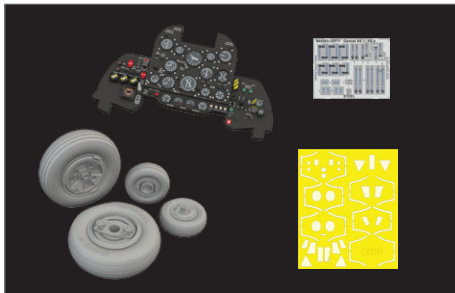

644272 Gannet AS.1/AS.4 **LööKplus** 1/48 Airfix

DETAIL

LööKplus

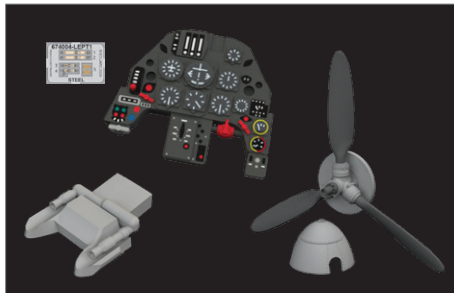

674008 Bf 109G-2 **LööKplus** 1/72 Eduard

DETAIL

LööKplus

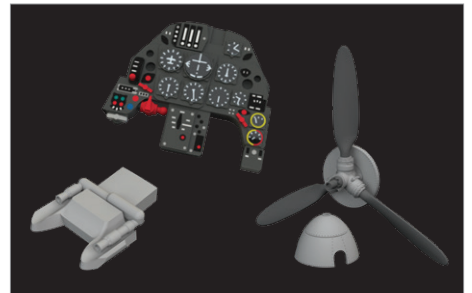

674009 Bf 109G-4 **LööKplus** 1/72 Eduard

DETAIL

BIGSIN

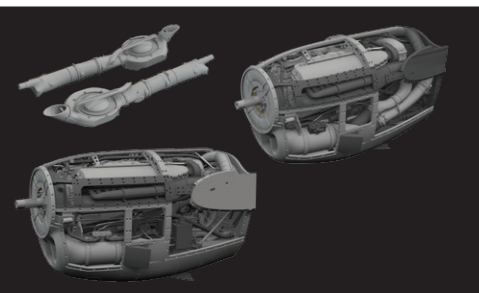

SIN648126 P-38J engines 1/48 Tamiya

DETAIL

BIGSIN

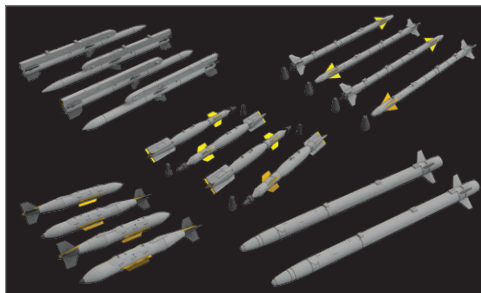

SIN67224 F-35A armament 1/72 Tamiya

DETAIL

Limited edition kit of WWII US medium bomber aircraft B-26F/G in 1/72 scale. In the box are machines from the MTO, ETO and PTO.

BASIC INFO:

NAME: **MARAUDER**

CAT. NO.: 2146

SCALE: 1/72

EDITION: Limited

CONTENTS:

SPRUES: Hasegawa

PE-SETS: Yes, pre-painted

PAINTING MASK: Yes

MARKING OPTIONS: 8

BRASSIN: Yes, wheels

RELATED PRODUCTS:

- 72703 B-26 Marauder upgrade set (PE-Set)
- 73007 Ammunition Belts US Cal.0.50 (PE-Set)
- 672038 US 250lb bombs (Brassin)
- 672039 US 500lb bombs (Brassin)
- 672241 B-26 Marauder wheels (Brassin)
- 672242 B-26 Marauder engines (Brassin)
- 672244 US 1000lb bombs (Brassin)
- 3DL72033 B-26 Marauder SPACE (3D Decal Set)

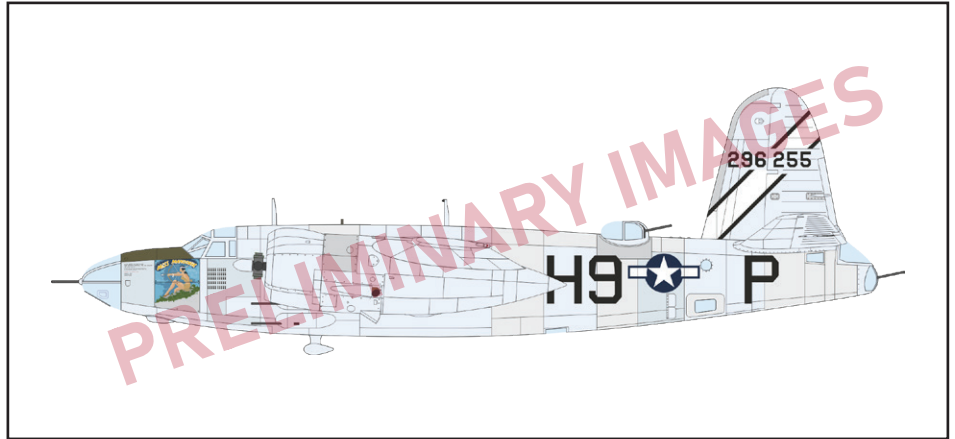

KIT PARTS

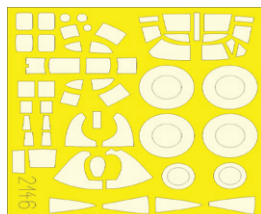
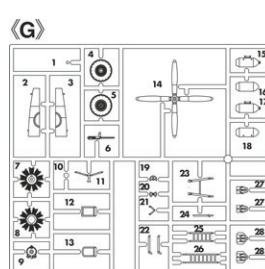
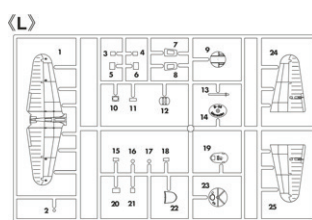
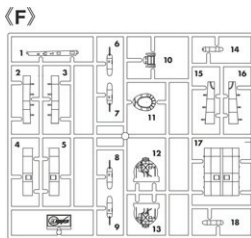
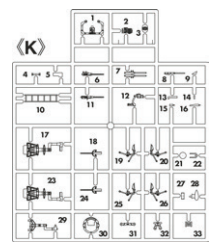
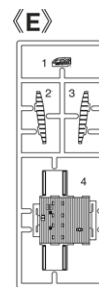
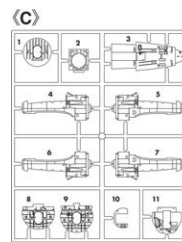
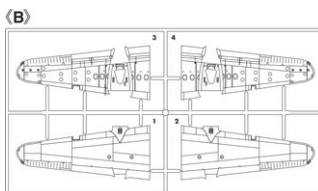
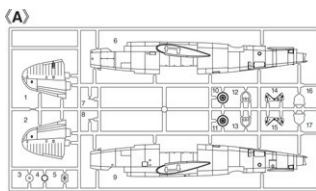

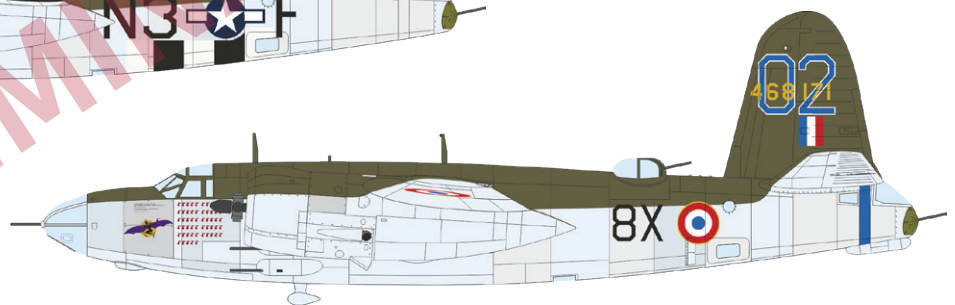
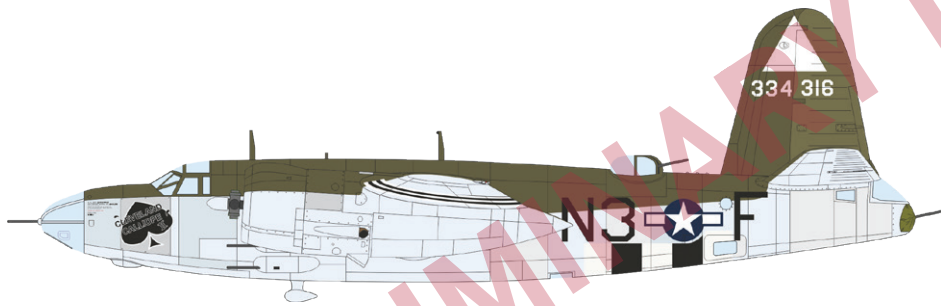
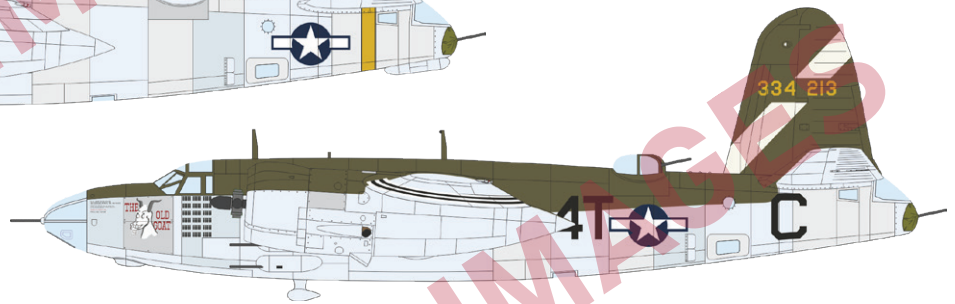
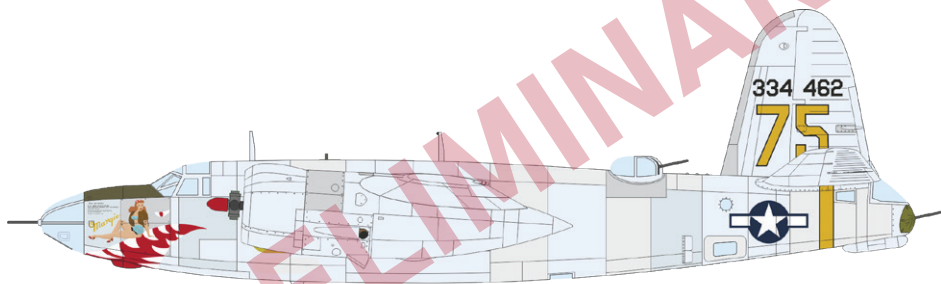
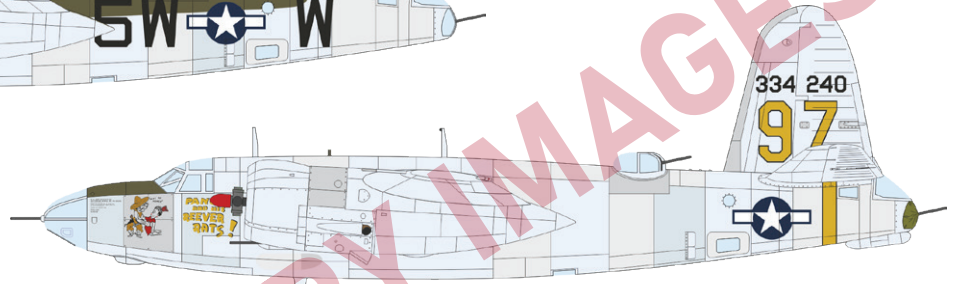
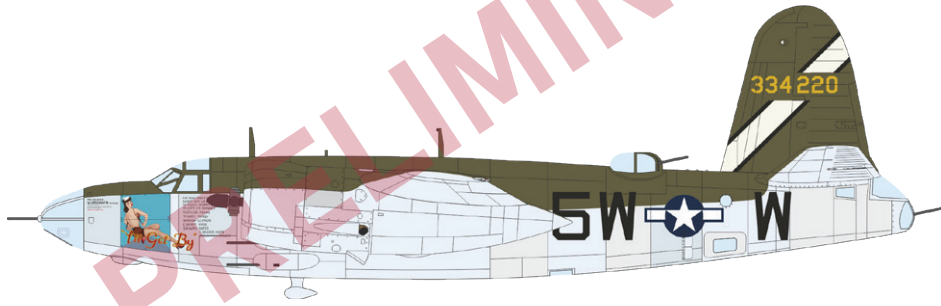
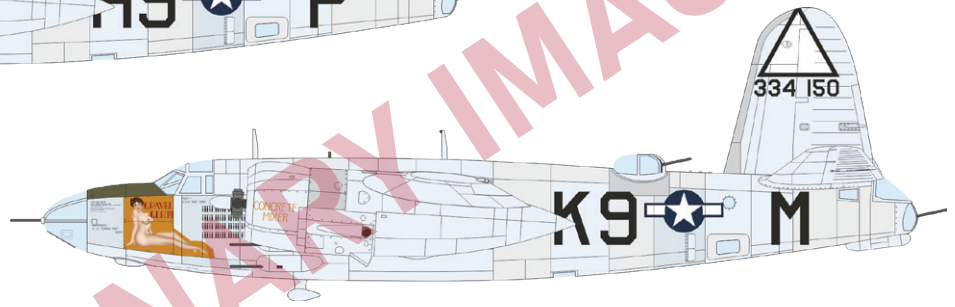
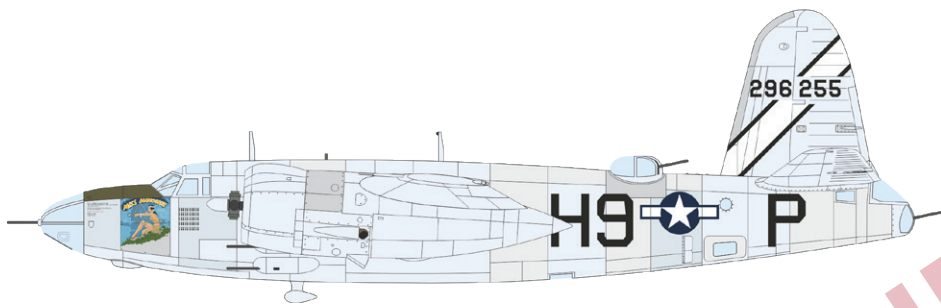

PRELIMINARY IMAGES

The Weekend edition kit of British fighter aircraft Spitfire Mk.Vb in 1/48 scale. The kit presents Spitfires used during Operation Overlord.

BASIC INFO:

NAME: **Spitfire Mk.Vb OVERLORD**

CAT. NO.: 84200

SCALE: 1/48

EDITION: Weekend

CONTENTS:

SPRUES: Eduard

PE-SETS: Yes

PAINTING MASK: No

MARKING OPTIONS: 4

BRASSIN: No

RELATED PRODUCTS:

481065 Spitfire Mk.V landing flaps (PE-Set)

FE1207 Spitfire Mk.V seatbelts STEEL (PE-Set)

FE1322 Spitfire Mk.Vb Weekend (PE-Set)

644113 Spitfire Mk.V LööK (Brassin)

648640 Spitfire Mk.V engine (Brassin)

648663 Spitfire Mk.V cockpit (Brassin)

648664 Spitfire Mk.V wheels (Brassin)

648665 Spitfire Mk.Vb gun bays (Brassin)

648667 Spitfire Mk.V three-stacks exhausts rounded (Brassin)

648668 Spitfire Mk.V three-stacks exhausts fishtail (Brassin)

648669 Spitfire Mk.V six-stacks exhausts fishtail (Brassin)

648738 Spitfire Mk.V landing flaps PRINT (Brassin)

SIN64886 Spitfire Mk.Vb ADVANCED (Brassin)

3DL48031 Spitfire Mk.V SPACE (3D Decal Set)

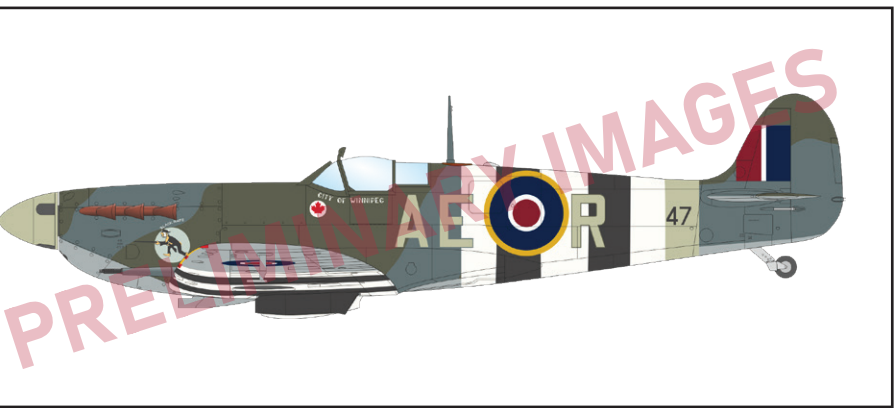

KIT PARTS

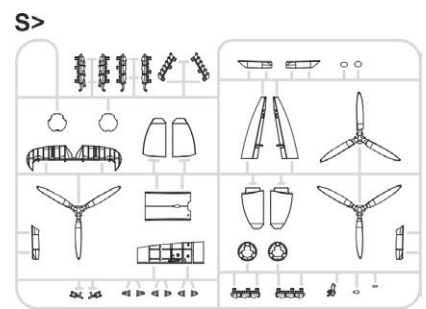
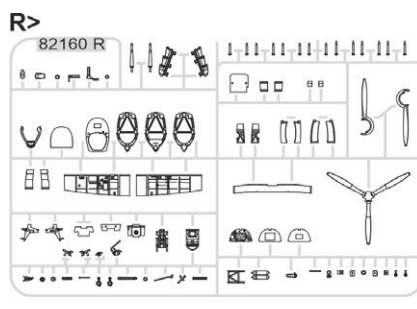
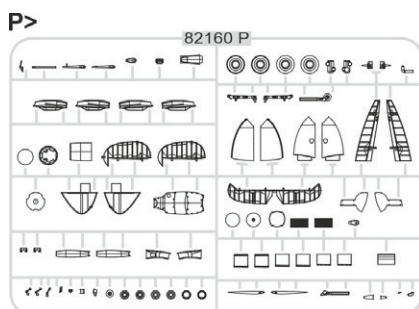
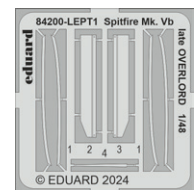
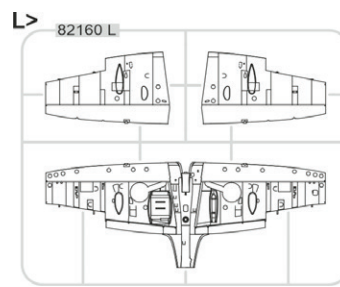
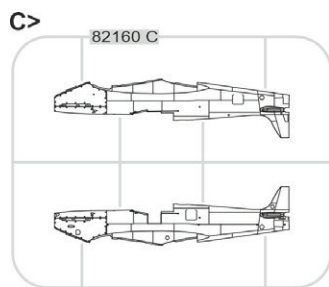
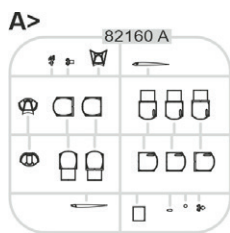

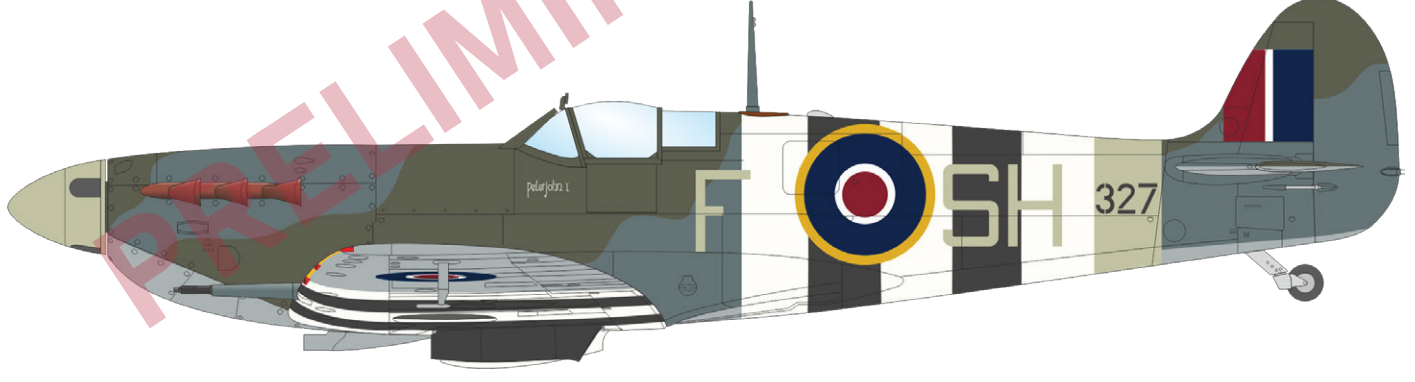
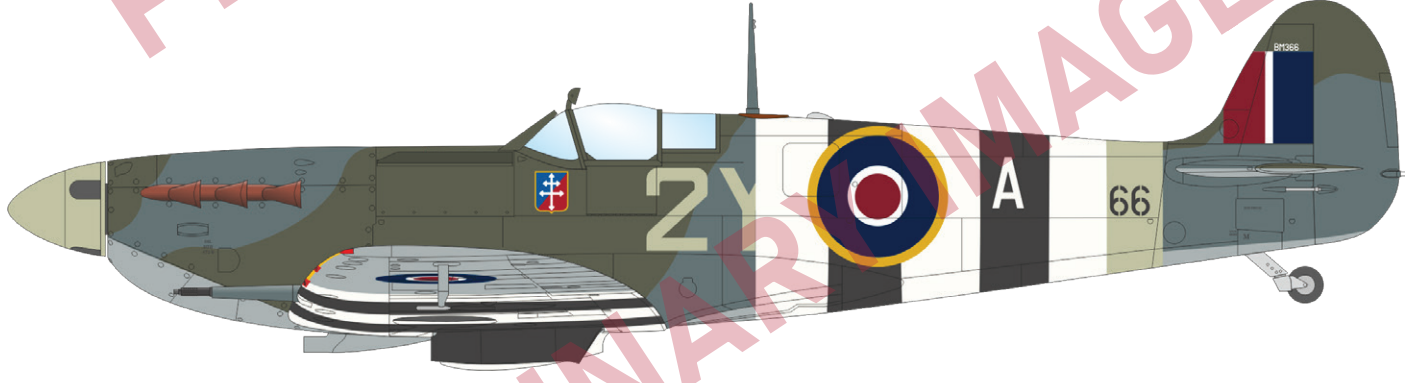
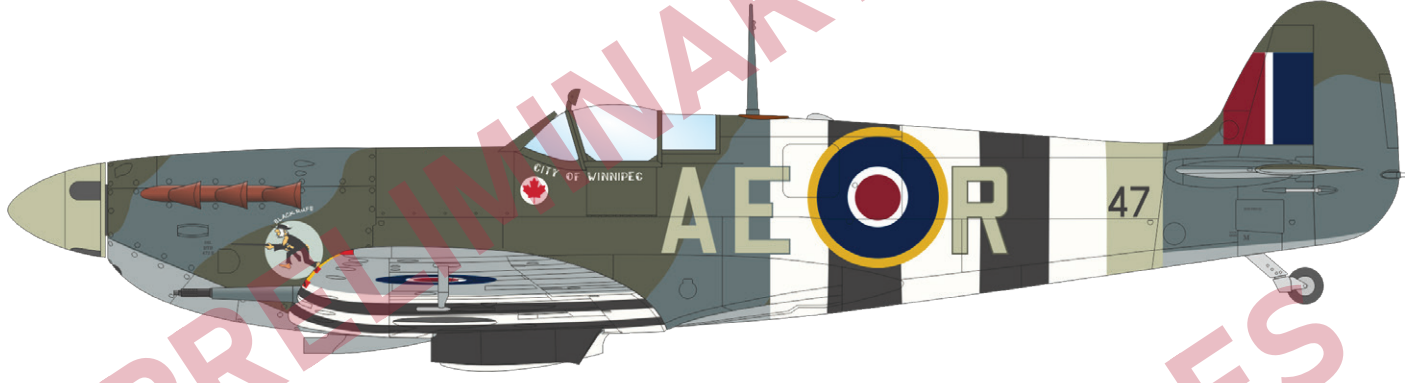
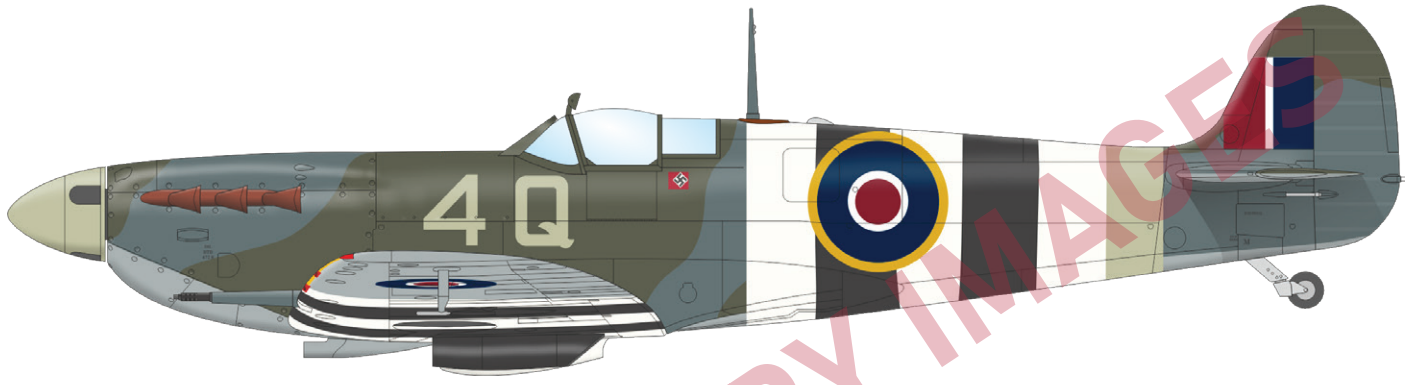

PRELIMINARY IMAGES

The ProfiPACK edition kit of the German fighter plane Bf 109G-6 in 1/72 scale. From the kit it is possible to build Messerschmitts with standard canopy and standard rudder.

BASIC INFO:

NAME: **Bf 109G-6**

CAT. NO.: 70159

SCALE: 1/72

EDITION: ProfiPACK

CONTENTS:

SPRUES: Eduard

PE-SETS: Yes, pre-painted

PAINTING MASK: Yes

MARKING OPTIONS: 6

BRASSIN: No

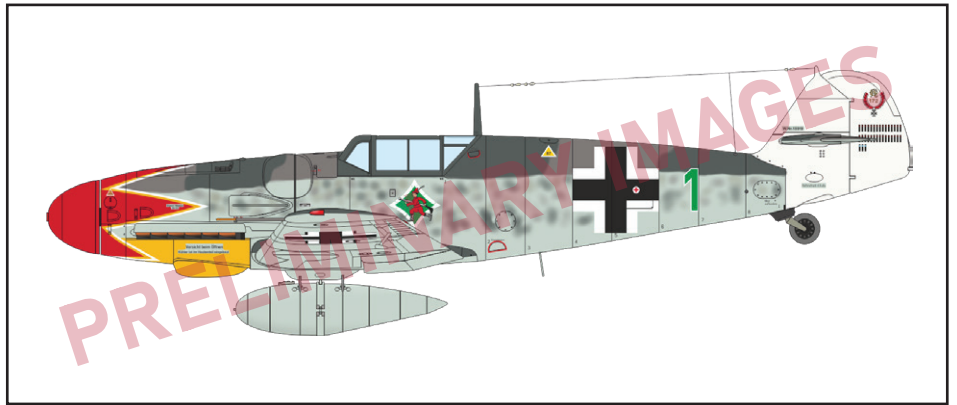

RELATED PRODUCTS:

- 674006 Bf 109G-6 LööK (Brassin)
- 672292 Luftwaffe rudder pedals PRINT (Brassin)
- 672324 Bf 109 SC250 bomb (Brassin)
- 672329 Bf 109 balance weights PRINT (Brassin)
- 672338 Bf 109G undercarriage legs BRONZE (Brassin)
- 672344 Bf 109G radio compartment PRINT (Brassin)
- 672346 Bf 109G propeller PRINT (Brassin)
- 672347 Bf 109G-5/G-6 cockpit PRINT (Brassin)
- 672348 Bf 109G-5/G-6 wheels PRINT (Brassin)
- 672352 Bf 109G-6 engine PRINT (Brassin)
- 672355 Bf 109G-5/G-6 gun barrels PRINT (Brassin)

KIT PARTS

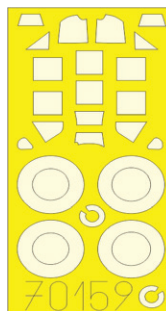
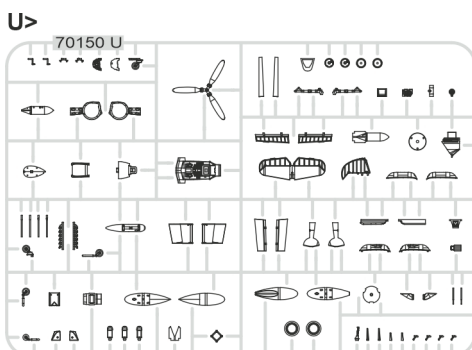
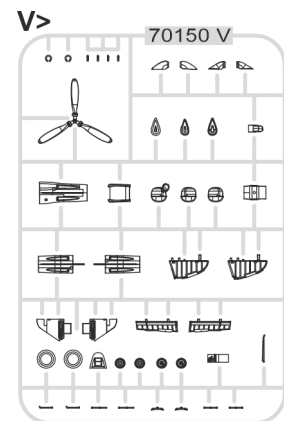
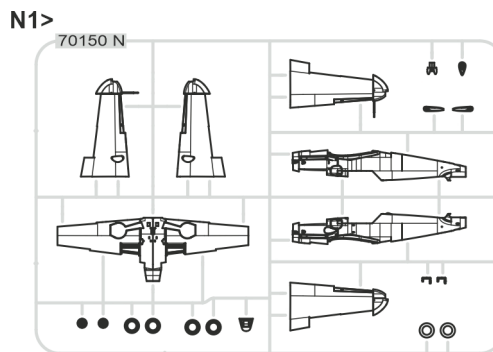
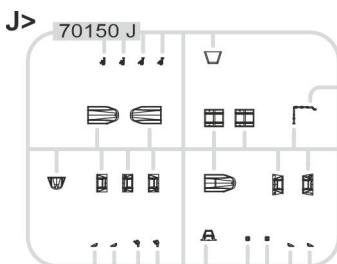

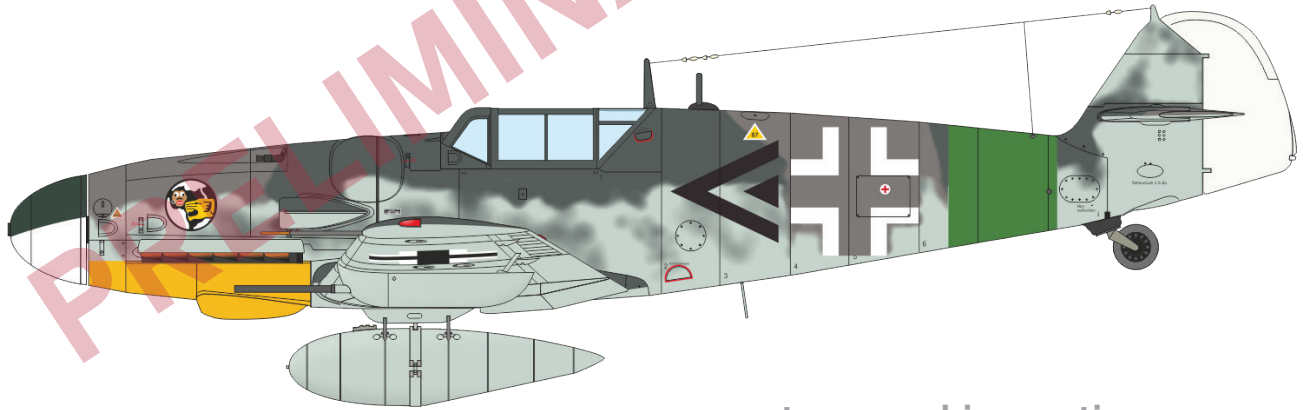
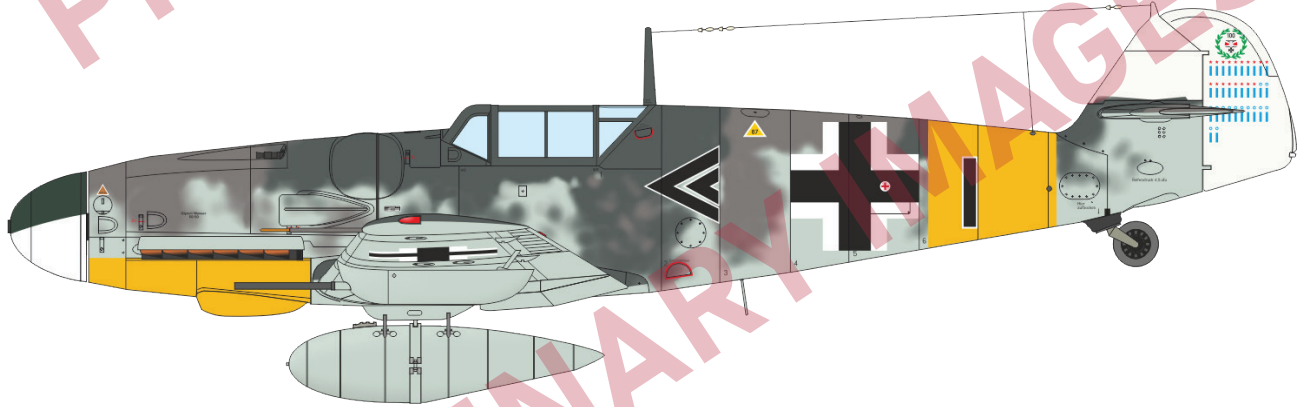
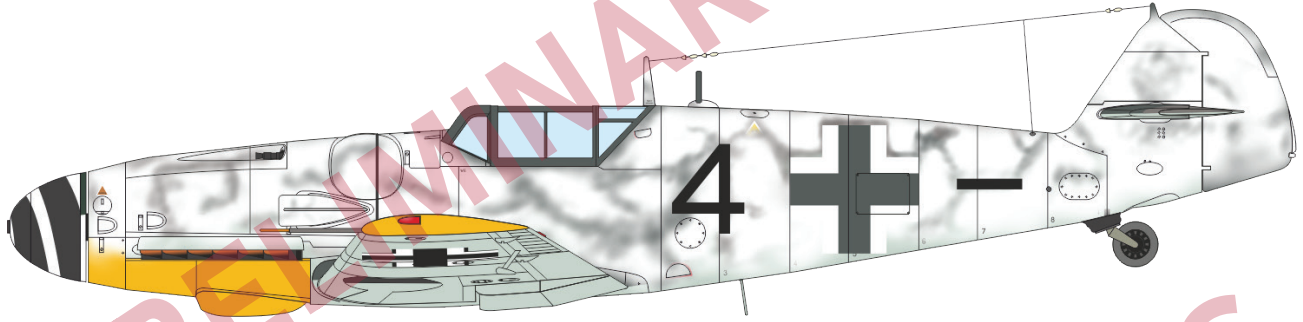
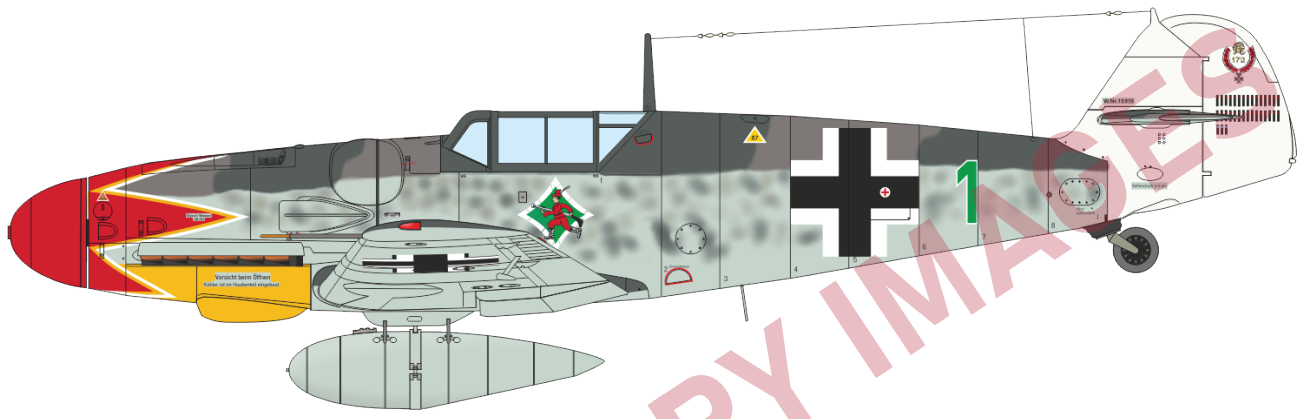

+ two marking options

ProfiPACK edition kit of German WWII fighter aircraft Fw 190A-2 in 1/48 scale. The kit offers the aircraft with two-cannon as well as four-cannon wings.

BASIC INFO:

NAME: **Fw 190A-2 Re-release**

CAT. NO.: 82146

SCALE: 1/48

EDITION: ProfiPACK

CONTENTS:

SPRUES: Eduard

PE-SETS: Yes, pre-painted

PAINTING MASK: Yes

MARKING OPTIONS: 5

BRASSIN: Yes, wheel bay doors

RELATED PRODUCTS:

648356 Fw 190A wingroot gun bays (Brassin)

648366 Fw 190A propeller (Brassin)

648371 Fw 190A control surfaces early (Brassin)

648381 Fw 190A exhaust stacks (Brassin)

648736 Fw 190A landing flaps PRINT (Brassin)

3DL48182 Fw 190A-2 SPACE (3D Decal Set)

D48040 Fw 190A-2 national insignia (Decal Set)

EX587 Fw 190A TFace (Mask)

Re-release

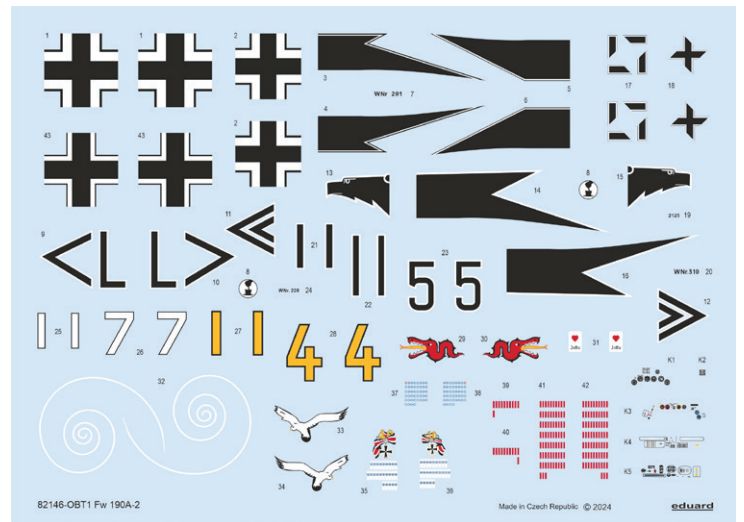

KIT PARTS

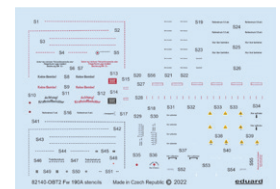
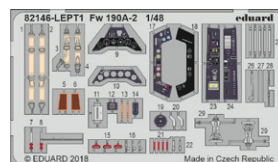
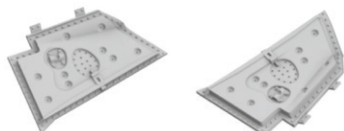
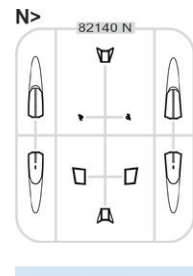
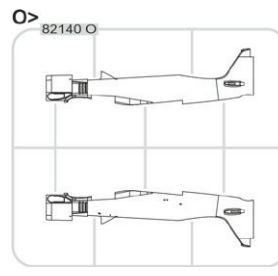
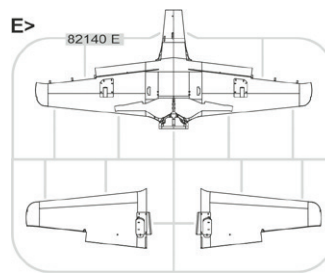
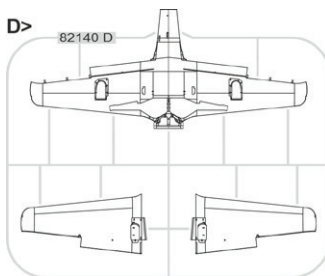
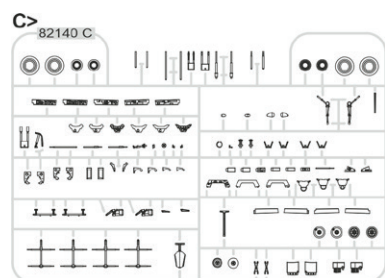
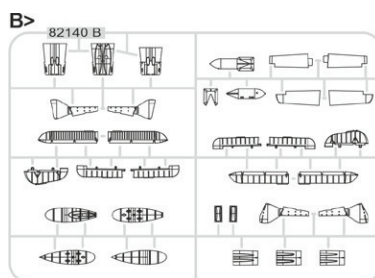
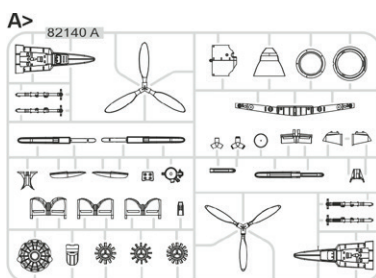

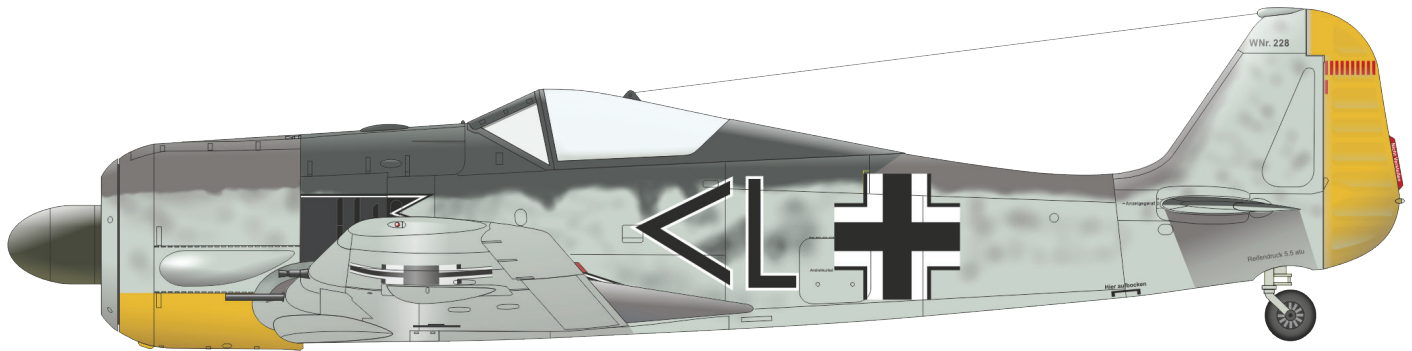

WNr. 0125228, Ofw. Erwin Leibold, Stab I./JG 26,
St. Omer-Arques, France, July 1942

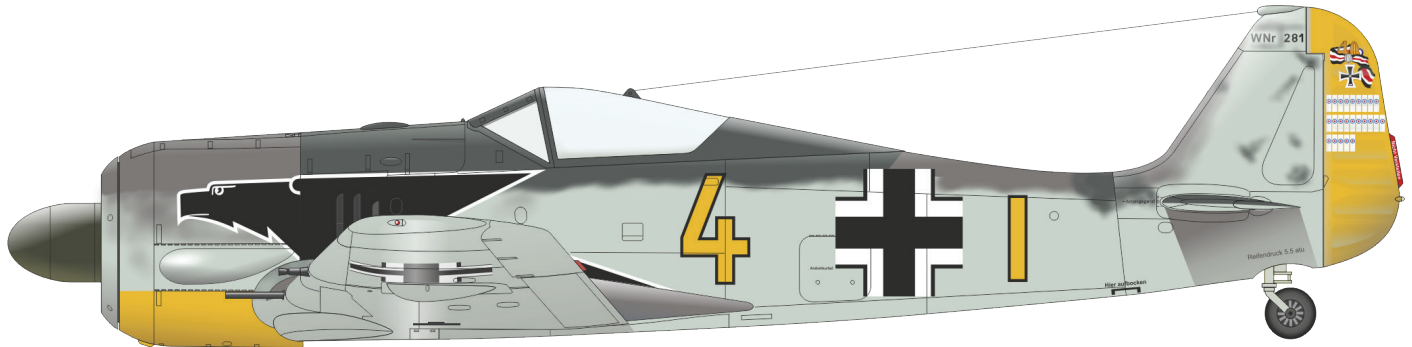

WNr. 0125281, Oblt. Siegfried Schnell, CO of 9./JG 2,
Théville, France, June 1942

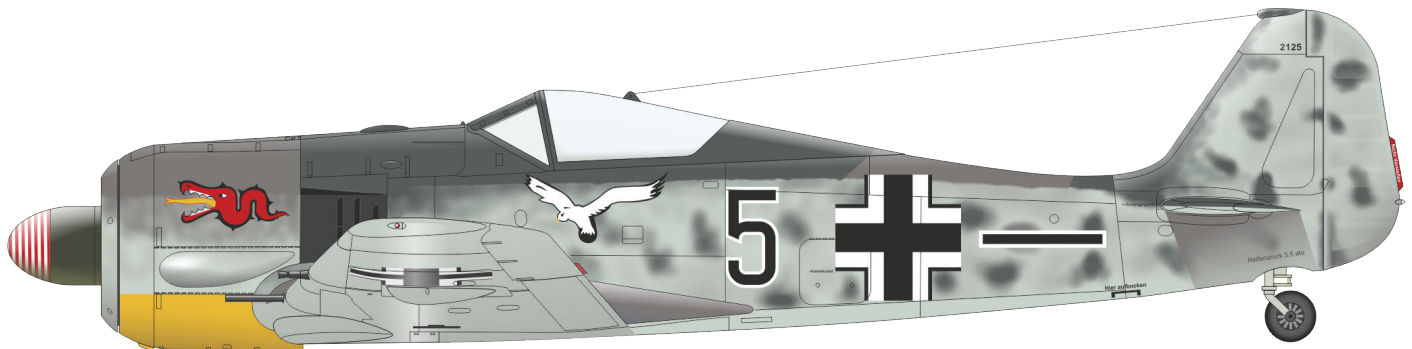

WNr. 0122125, Oblt. Max Buchholz, CO of 5./JG 1, Katwijk,
the Netherlands, Summer 1942

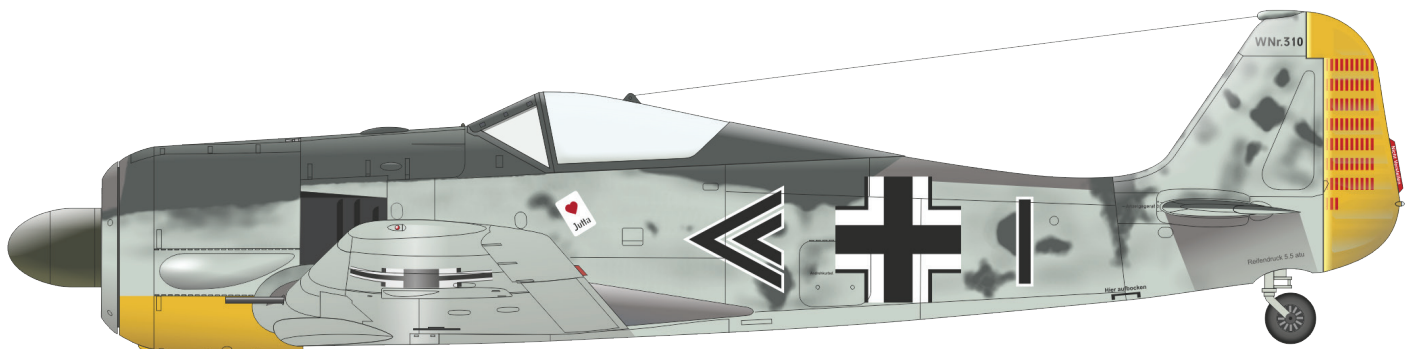

WNr. 0125310, Hptm. Josef Priller, CO of III./JG 26,
Wevelghem, Belgium, June 1942

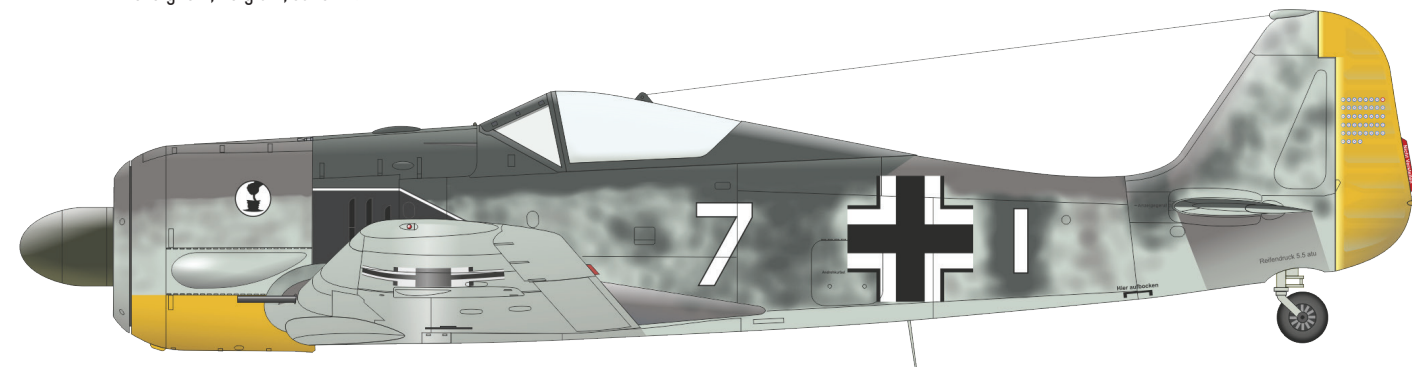

Oblt. Egon Mayer, CO of 7./JG 2, Théville, France, Summer 1942

32490 A-20J/K / Boston Mk.IV bomb bay
1/32 HKM

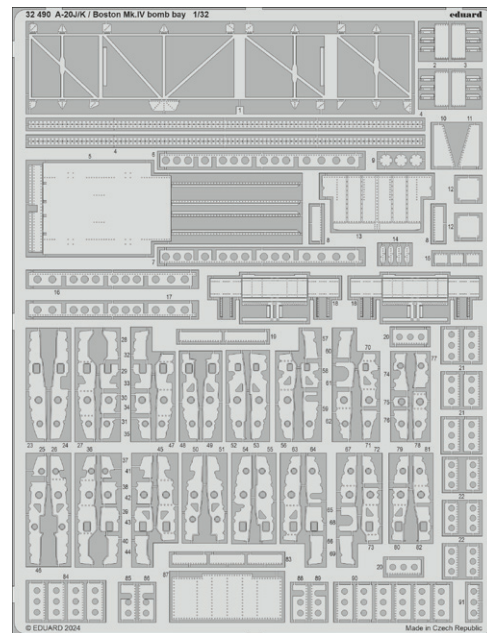

32491 A-20J/K / Boston Mk.IV main wheel well
1/32 HKM

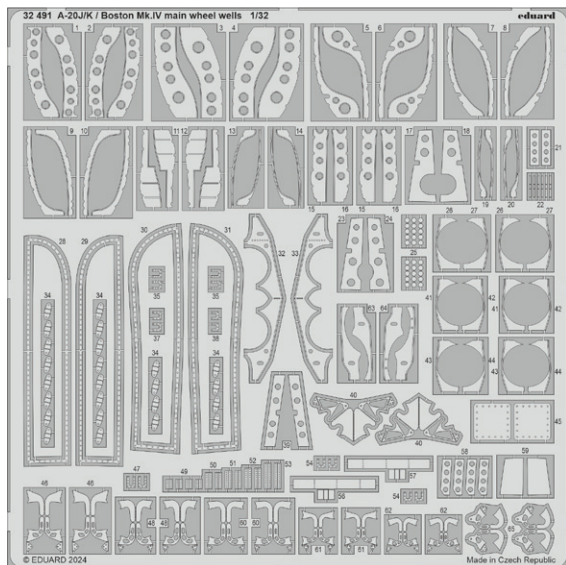

32107 B5N2
1/35 Border Model

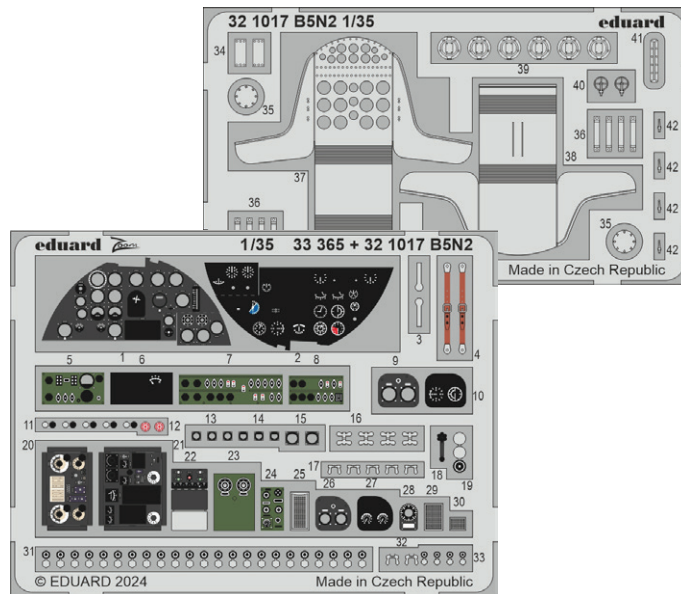

321018 A-20J/K
1/32 HKM

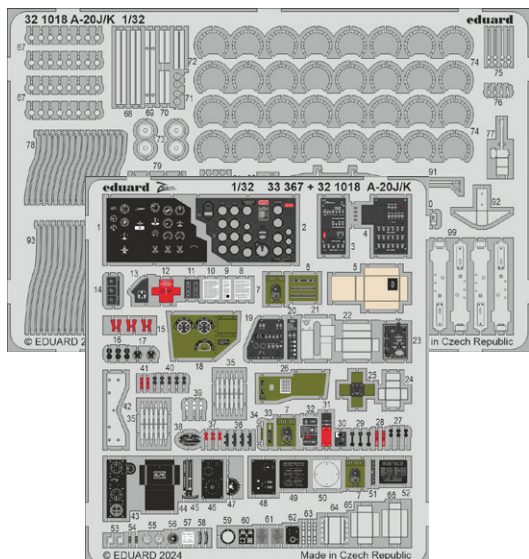

321019 Boston Mk.IV
1/32 HKM

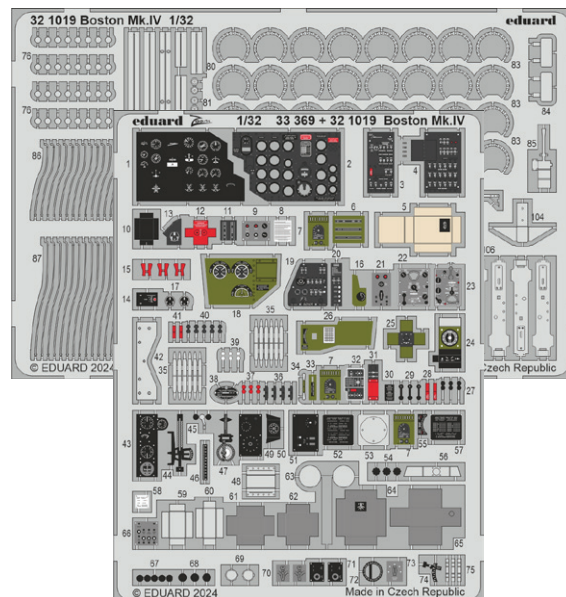

481139 TBD-1 landing flaps
1/48 Hobby Boss

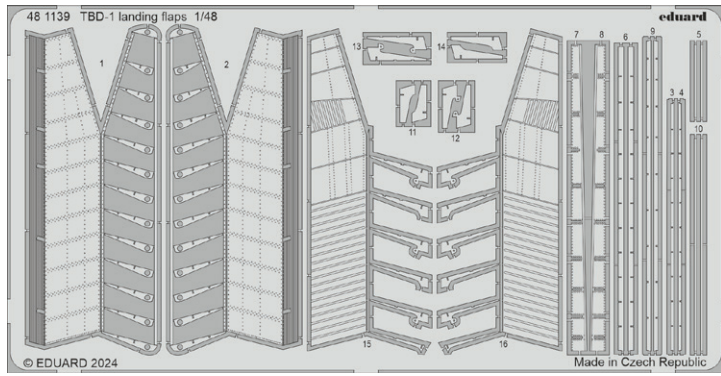

491452 TBD-1
1/48 Hobby Boss

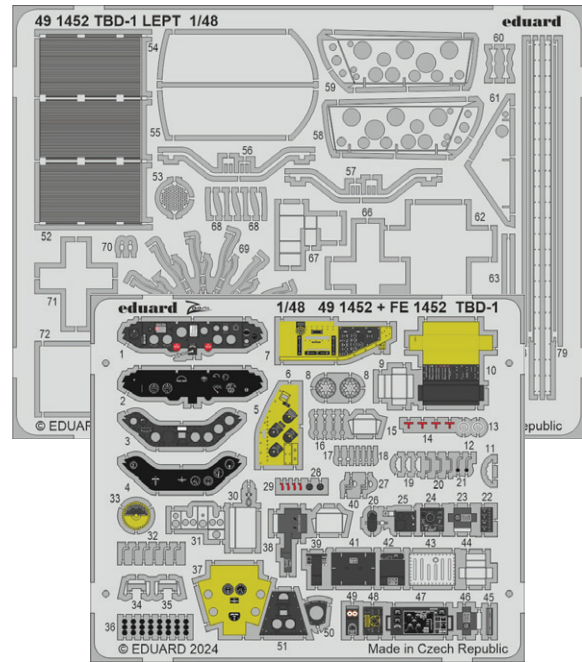

72737 SM.79 exterior
1/72 Italeri

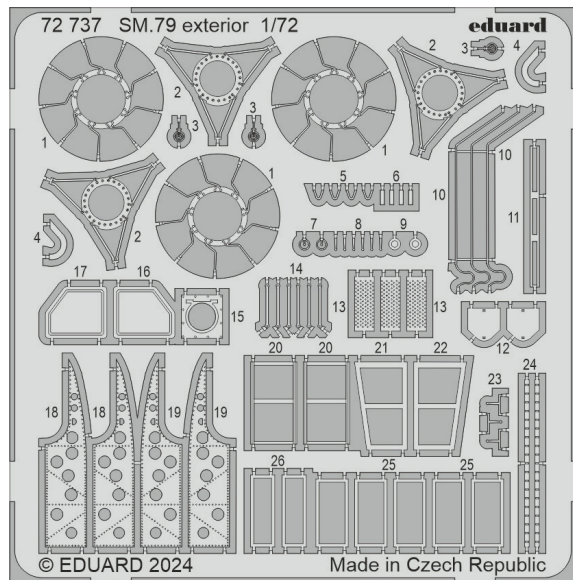

73824 SM.79 interior
1/72 Italeri

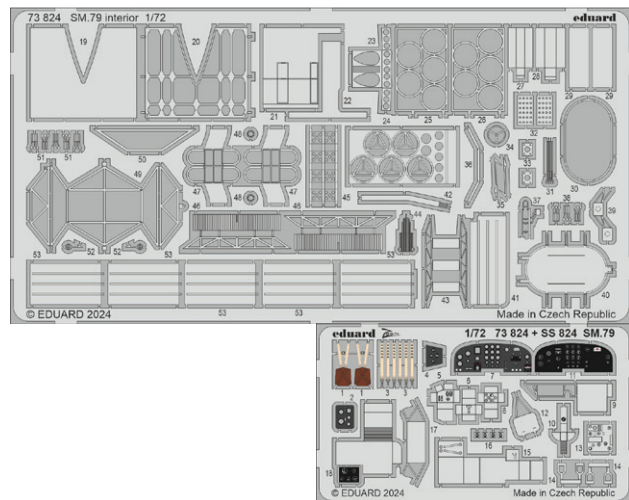

33365 B5N2
1/35 Border Model

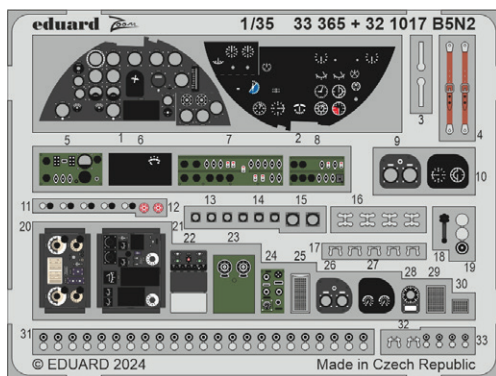

33366 B5N2 seatbelts STEEL
1/35 Border Model

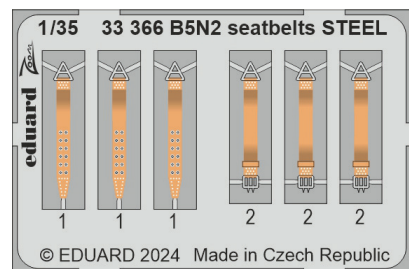

33367 A-20J/K
1/32 HKM

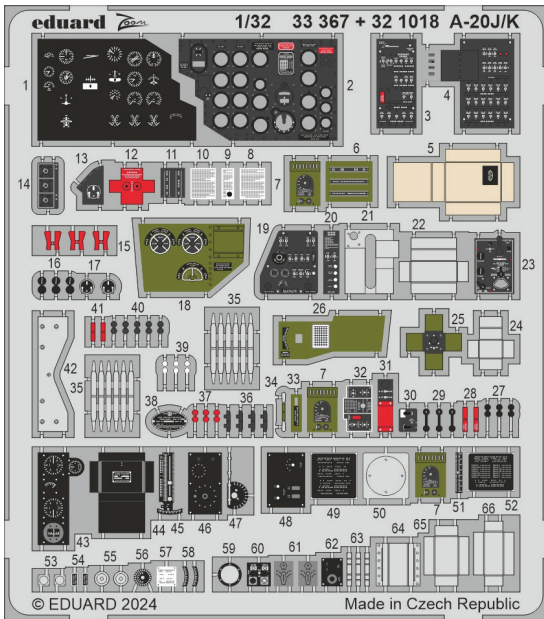

33368 A-20J/K seatbelts STEEL
1/32 HKM

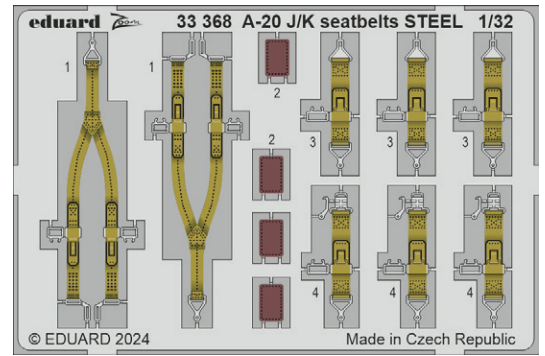

33369 Boston Mk.IV
1/32 HKM

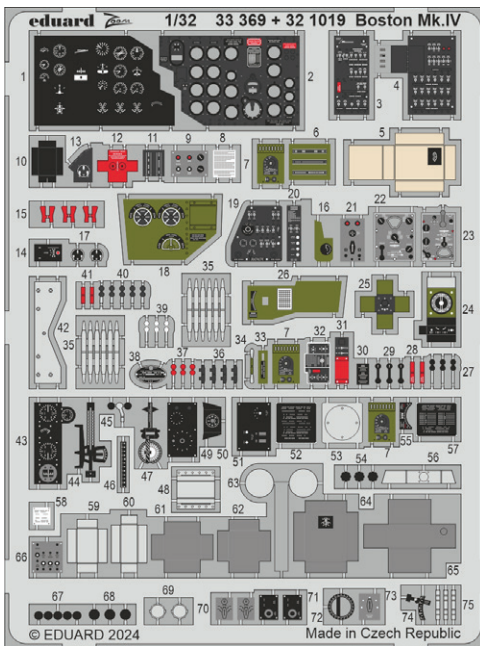

33370 Boston Mk.IV seatbelts STEEL
1/32 HKM

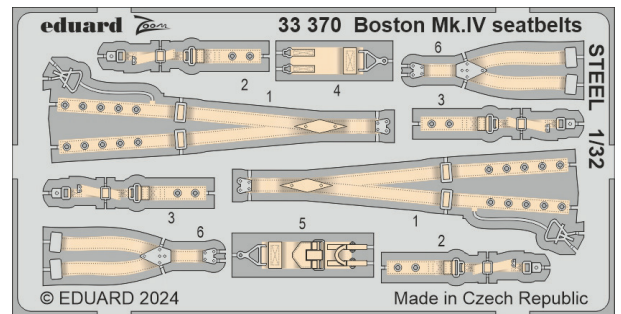

FE1451 B-24J seatbelts STEEL
1/48 Hobby Boss

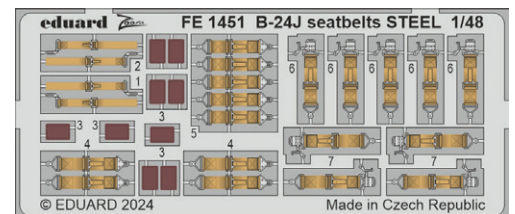

FE1452 TBD-1
1/48 Hobby Boss

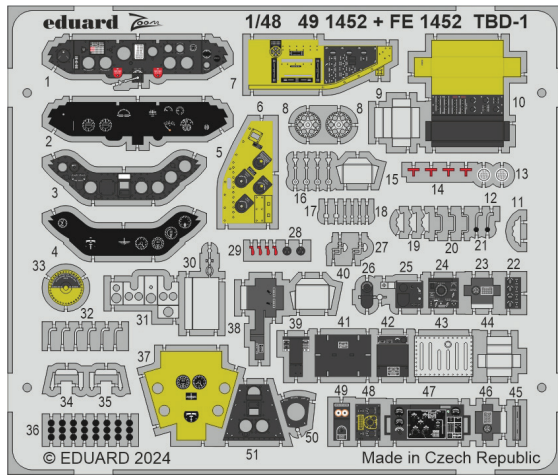

FE1453 TBD-1 seatbelts STEEL
1/48 Hobby Boss

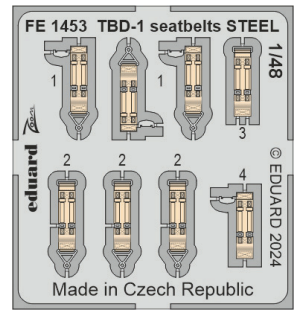

FE1455 B-26B Marauder seatbelts STEEL
1/48 ICM

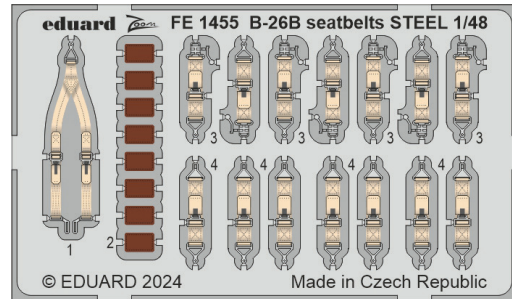

SS824 SM.79
1/72 Italeri

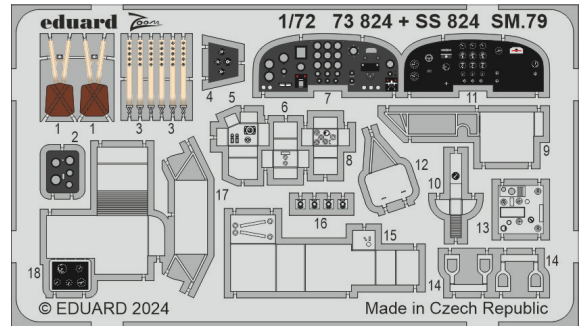

3DL32023 B5N2 SPACE
1/35 Border Model

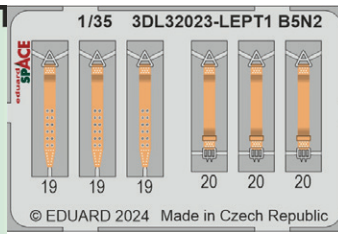
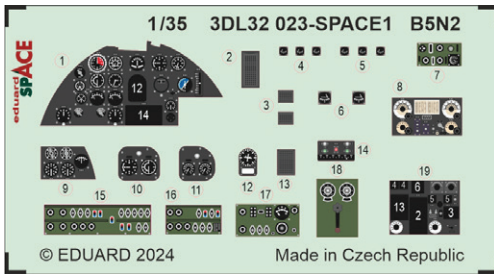

3DL48181 TBD-1 SPACE
1/48 Hobby Boss

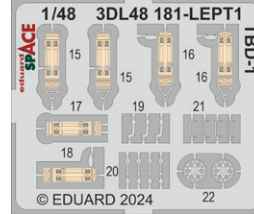
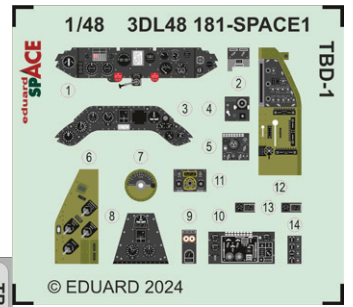

3DL48182 Fw 190A-2 SPACE
1/48 Eduard

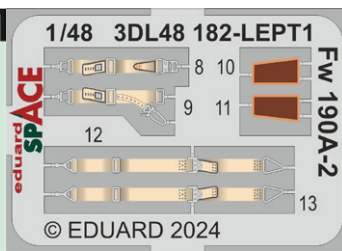
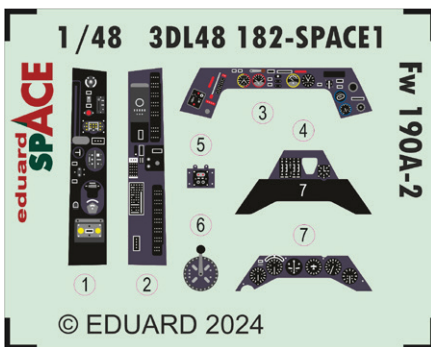

3DL72033 B-26 Marauder SPACE
1/72 Eduard

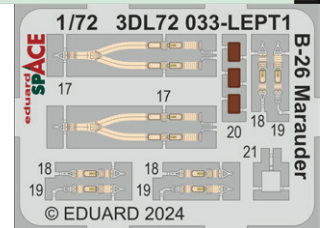
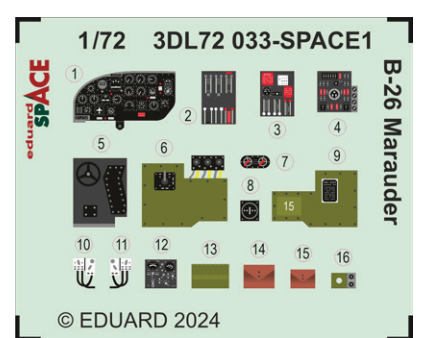

3DL53014 US Navy WW2 ensign flag
for CVL, CVE, CL & DD SPACE 1/350



644264 F4U-1A Löök 1/48 Magic Factory

Löök set - Brassin pre-painted dashboard and STEEL seatbelts for F4U-1A in 1/48 scale.
Easy to assemble, replaces plastic parts.
Recommended kit: Magic factory

Set contains:

- resin: 1 part
- decals: no
- photo-etched details: yes, pre-painted
- painting mask: no

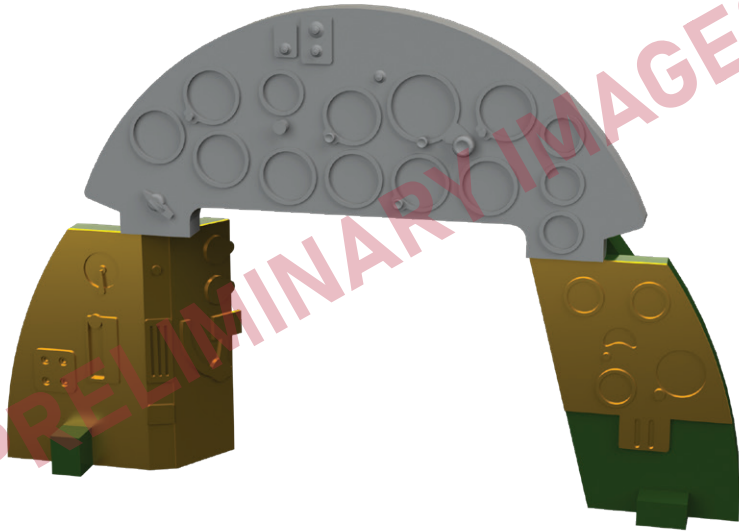

644269 P-47D-30 Löök 1/48 MINIART

Löök set - Brassin pre-painted dashboard and STEEL seatbelts for P-47D-30 in 1/48 scale.
Easy to assemble, replaces plastic parts.
Recommended kit: Miniart

Set contains:

- resin: 2 parts
- decals: no
- photo-etched details: yes, pre-painted
- painting mask: no

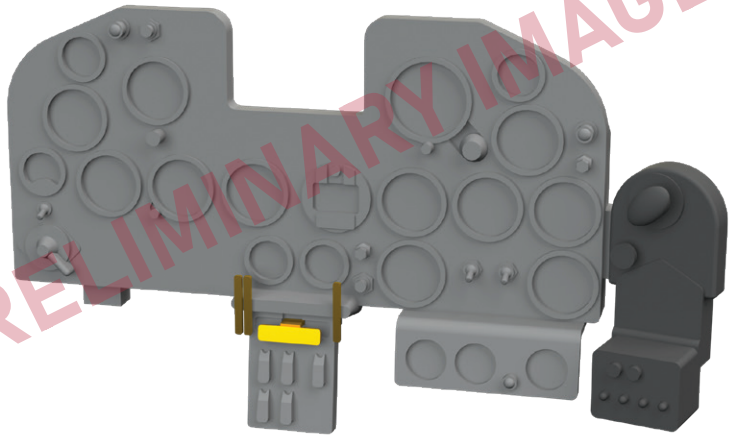

644270 I-16 Type 24 Löök 1/48 Eduard

Löök set - Brassin pre-painted dashboard and STEEL seatbelts for I-16 Type 24 in 1/48 scale.
Easy to assemble, replaces plastic parts.
Recommended kit: Eduard

Set contains:

- resin: 1 part
- decals: no
- photo-etched details: yes, pre-painted
- painting mask: no

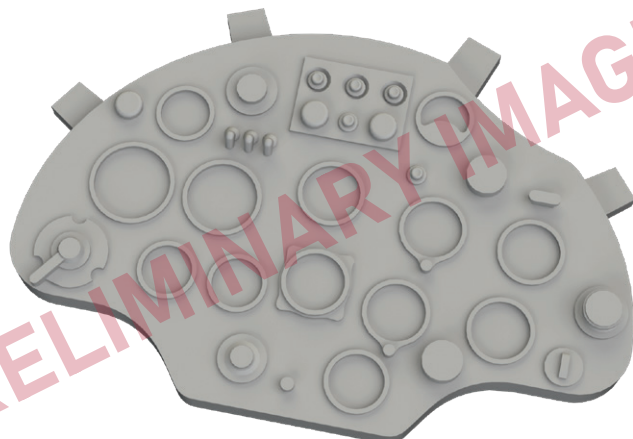

644271 FM-1 LööK 1/48 Tamiya

LööK set - Brassin pre-painted dashboard and STEEL seatbelts for FM-1 in 1/48 scale. Easy to assemble, replaces plastic parts. Recommended kit: Tamiya

Set contains:

- resin: 1 part
- decals: no
- photo-etched details: yes, pre-painted
- painting mask: no

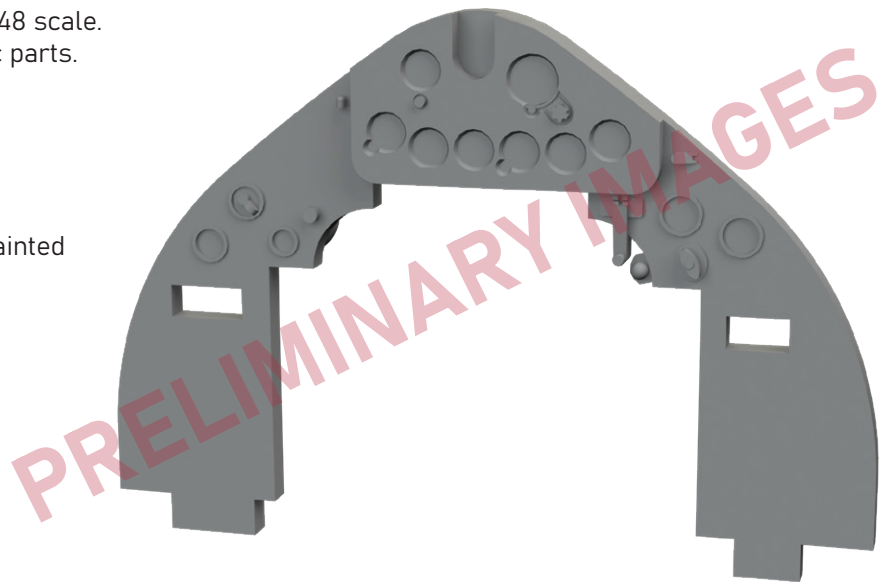

648910 F-4E parachute PRINT 1/48 Meng

Brassin set - a deployed parachute for F-4E in 1/48 scale. Made by direct 3D printing. Recommended kit: Meng

Set contains:

- 3D print: 4 parts
- decals: no
- photo-etched details: yes
- painting mask: no

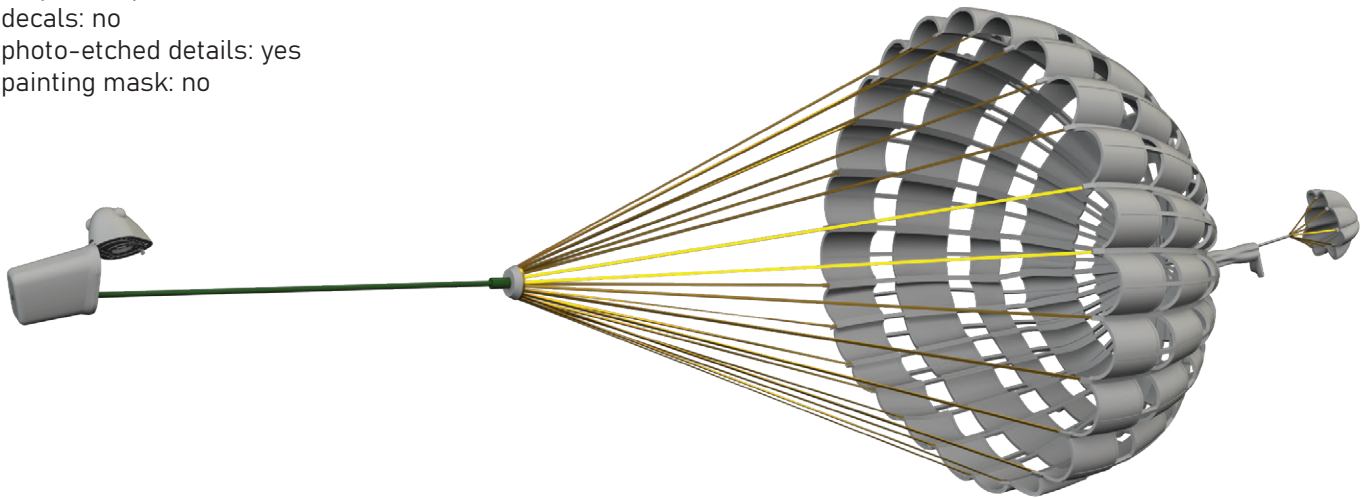

648983 Beaufort Mk.I engines PRINT 1/48 ICM

Brassin set - both engines for Beaufort Mk.I in 1/48 scale. Made by direct 3D printing. Recommended kit: Airfix

Set contains:

- 3D print: 16 parts
- decals: no
- photo-etched details: no
- painting mask: no

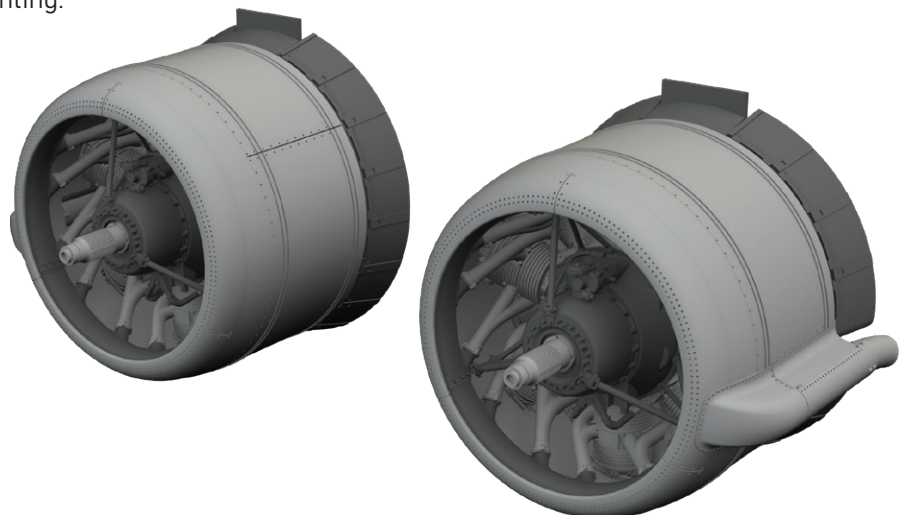

648989 P-51B/C wheels block tread 1/48 Eduard

Brassin set - the undercarriage wheels for P-51B or P-51C in 1/48 scale. The set consists of the main wheels and a tail wheel. Easy to assemble, replaces plastic parts. Recommended kit: Eduard

Set contains:

- resin: 3 parts
- 3D print: 2 parts
- decals: no
- photo-etched details: no
- painting mask: yes



648990 P-51B/C wheels diamond tread 2 1/48 Eduard

Brassin set - the undercarriage wheels for P-51B or P-51C in 1/48 scale. The set consists of the main wheels and a tail wheel. Easy to assemble, replaces plastic parts. Recommended kit: Eduard

Set contains:

- resin: 3 parts
- 3D print: 2 parts
- decals: no
- photo-etched details: no
- painting mask: yes



648991 P-51B/C wheels block tread 2 1/48 Eduard

Brassin set - the undercarriage wheels for P-51B or P-51C in 1/48 scale. The set consists of the main wheels and a tail wheel. Easy to assemble, replaces plastic parts. Recommended kit: Eduard

Set contains:

- resin: 3 parts
- 3D print: 2 parts
- decals: no
- photo-etched details: no
- painting mask: yes



648998 Bf 108 wheels spoked 1/48 Eduard

Brassin set - the undercarriage wheels for Bf 108 in 1/48 scale. The set consists of the main wheels and a tail wheel. Easy to assemble, replaces plastic parts. Recommended kit: Eduard

Set contains:

- resin: 5 parts
- decals: no
- photo-etched details: no
- painting mask: yes

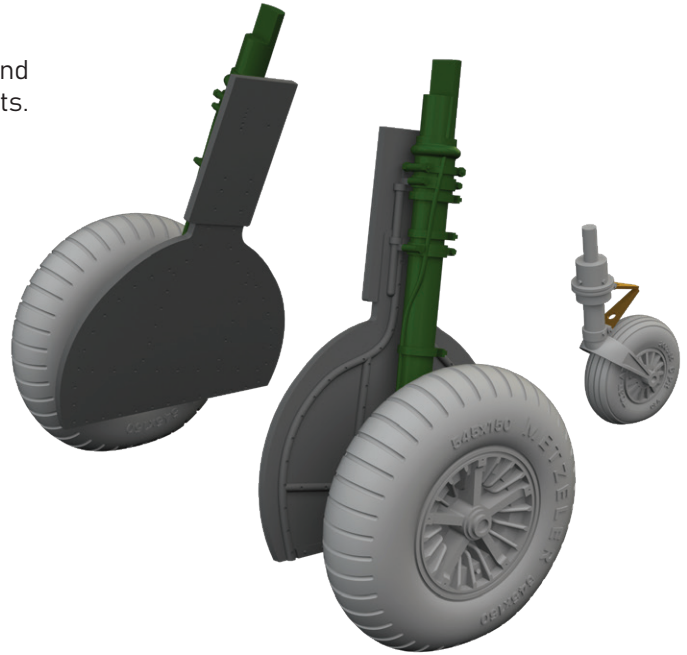

648999 Bf 108 wheels 1/48 Eduard

Brassin set - the undercarriage wheels for Bf 108 in 1/48 scale. The set consists of the main wheels and a tail wheel. Easy to assemble, replaces plastic parts. Recommended kit: Eduard

Set contains:

- resin: 5 parts
- decals: no
- photo-etched details: no
- painting mask: yes

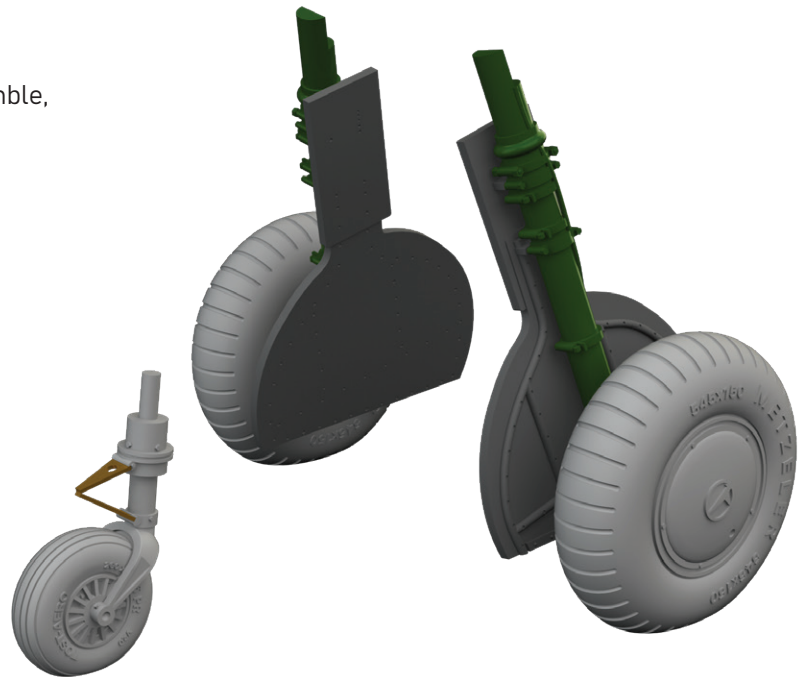

6481000 F-35B cockpit PRINT 1/48 Tamiya

Brassin set - cockpit for F-35B in 1/48 scale. Made by direct 3D printing. Recommended kit: Tamiya

Set contains:

- 3D print: 16 parts
- decals: yes
- photo-etched details: yes, pre-painted
- painting mask: no

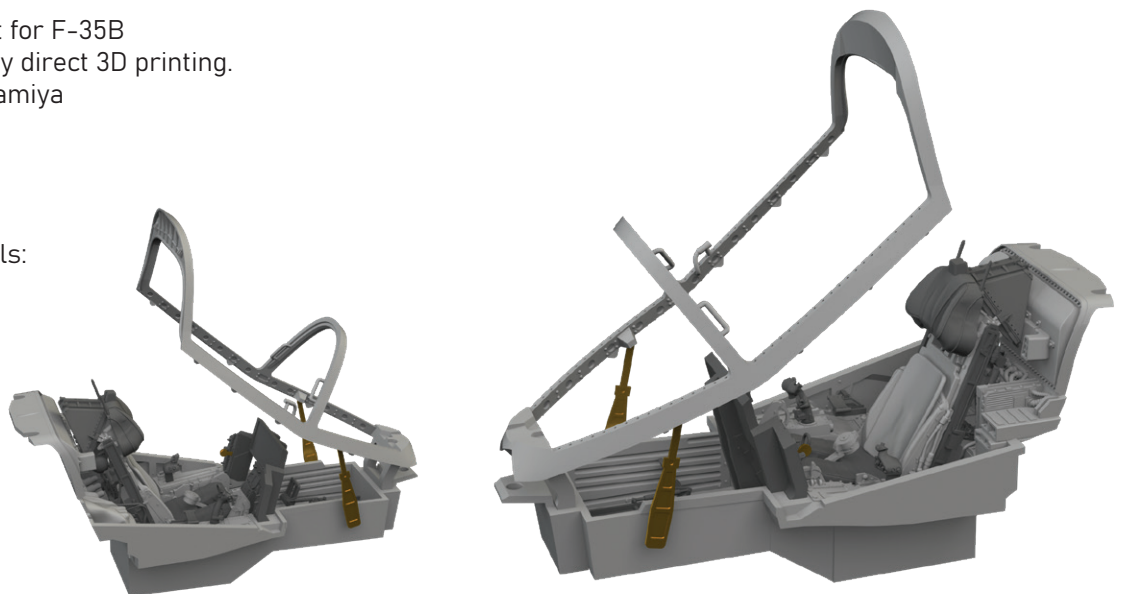

6481001 P-51B/C 108gal drop tanks PRINT 1/48 Eduard

Brassin set - fuel drop tanks for P-51B or P-51C in 1/48 scale. Made by direct 3D printing. Easy to assemble, replaces plastic parts. Recommended kit: Eduard

Set contains:

- 3D print: 6 parts
- decals: yes
- photo-etched details: yes
- painting mask: no

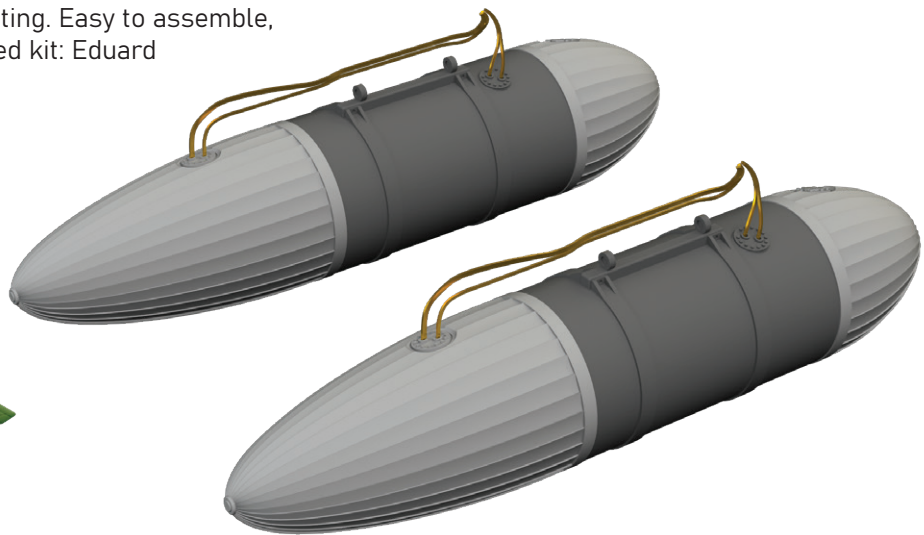
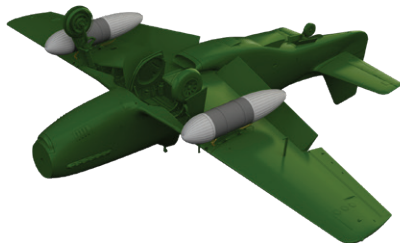

6481003 P-51B/C seat Type 2 PRINT 1/48 Eduard

Brassin set - pilot seat for P-51B or P-51C in 1/48 scale. Made by direct 3D printing. Easy to assemble, replaces plastic parts. Recommended kit: Eduard

Set contains:

- 3D print: 1 part
- decals: no
- photo-etched details: yes, pre-painted
- painting mask: no

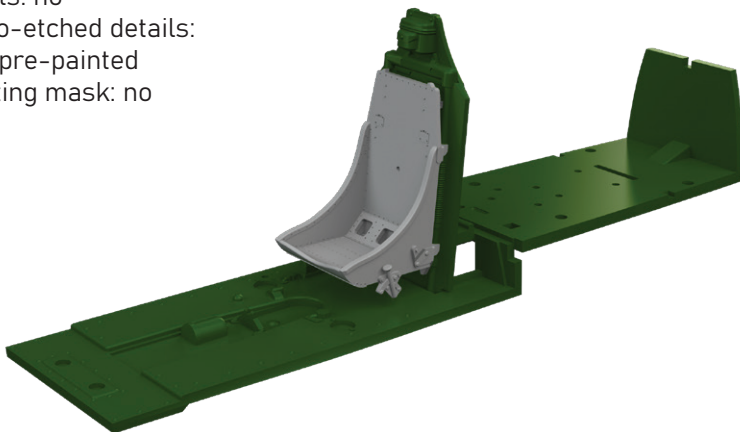

6481006 P-51B/C Hamilton Standard propeller 1/48 Eduard

Brassin set - propeller for P-51B or P-51C in 1/48 scale. Easy to assemble, replaces plastic parts. Recommended kit: Eduard

Set contains:

- resi: 9 parts
- decals: no
- photo-etched details: yes
- painting mask: no

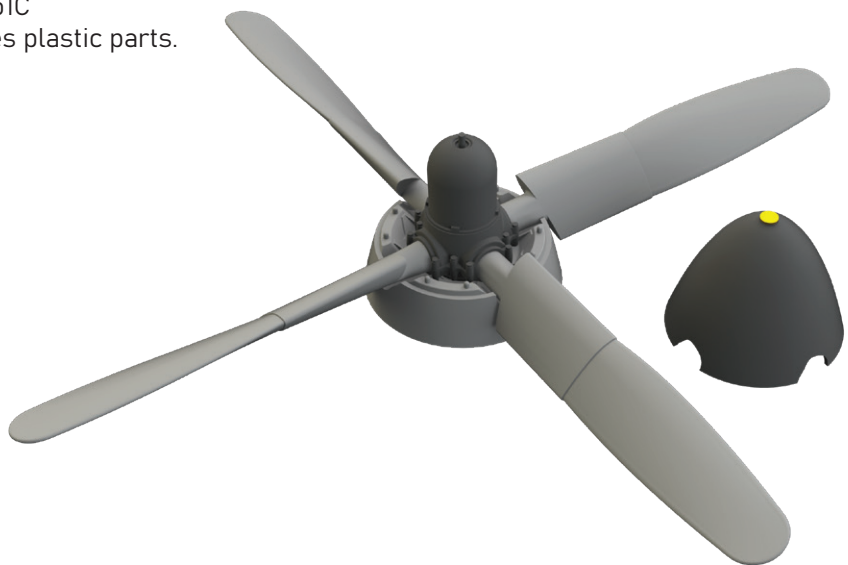
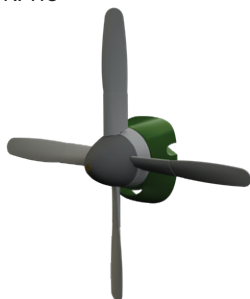

6481007 P-51B/C Hamilton Standard propeller uncuffed 1/48 Eduard

Brassin set - propeller for P-51B or P-51C in 1/48 scale. Easy to assemble, replaces plastic parts. Recommended kit: Eduard

Set contains:

- resi: 9 parts
- decals: no
- photo-etched details: yes
- painting mask: no

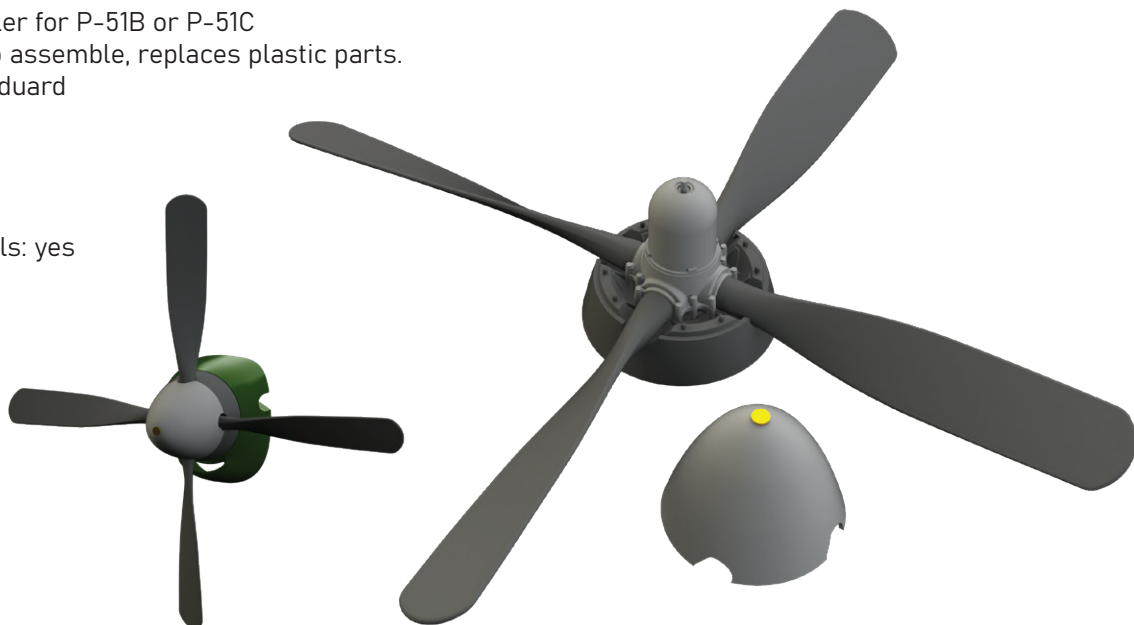

6481008 P-51B/C bazooka rocket launcher 1/48 Eduard

Brassin set - bazooka type rocket launchers for P-51B or P-51C in 1/48 scale. Recommended kit: Eduard

Set contains:

- resin: 8 parts
- decals: no
- photo-etched details: yes
- painting mask: no

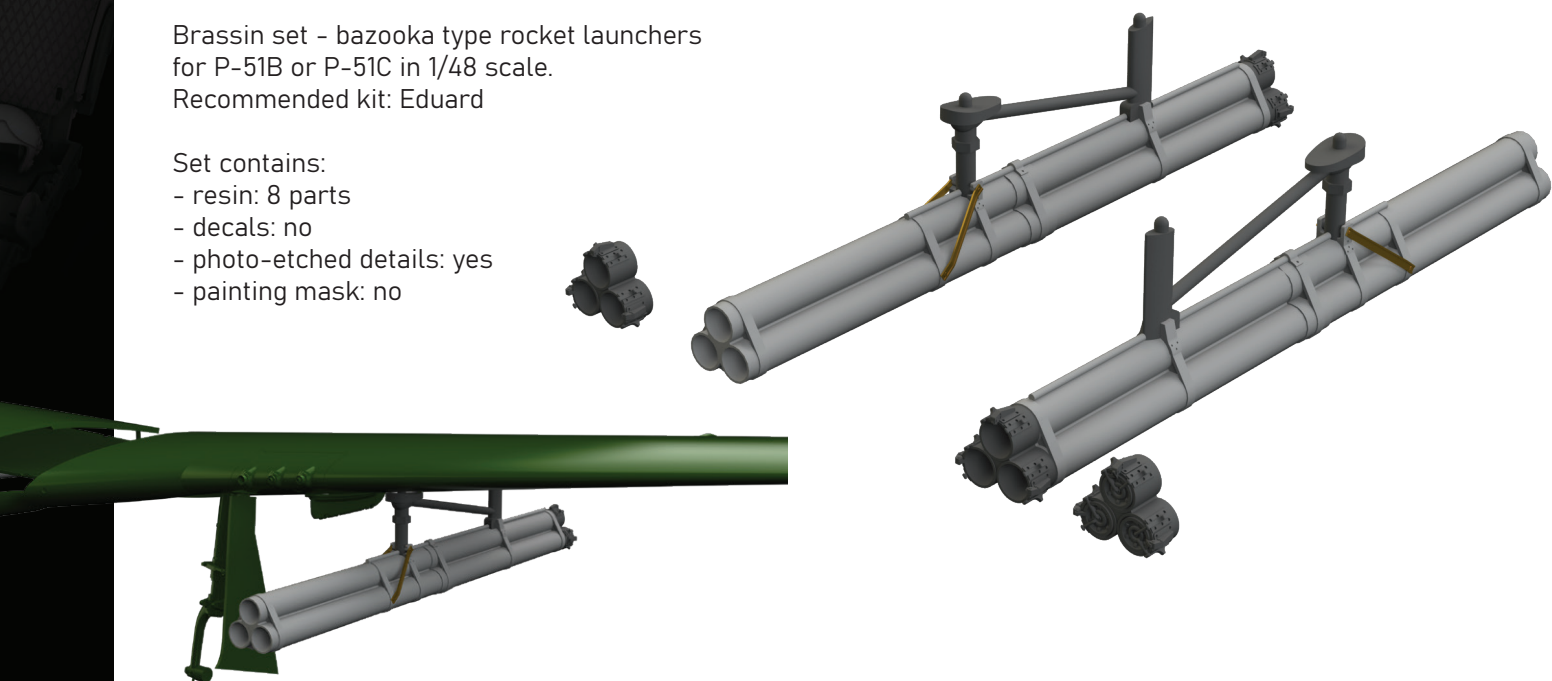

653019 IJN Type 96 25mm AA gun (single) PRINT 1/350

Brassin set - single Mounted 25mm AA gun for IJN vessels in 1/350 scale. Set consists of 20 guns. Made by direct 3D printing. Easy to assemble, replaces plastic parts.

Set contains:

- 3D print: 20 parts
- decals: no
- photo-etched details: yes
- painting mask: no



653020 IJN Type 96 25mm AA gun (double) PRINT 1/350

Brassin set - double Mounted 25mm AA gun for IJN vessels in 1/350 scale. Set consists of 18 guns. Made by direct 3D printing. Easy to assemble, replaces plastic parts.

Set contains:

- 3D print: 18 parts
- decals: no
- photo-etched details: yes
- painting mask: no

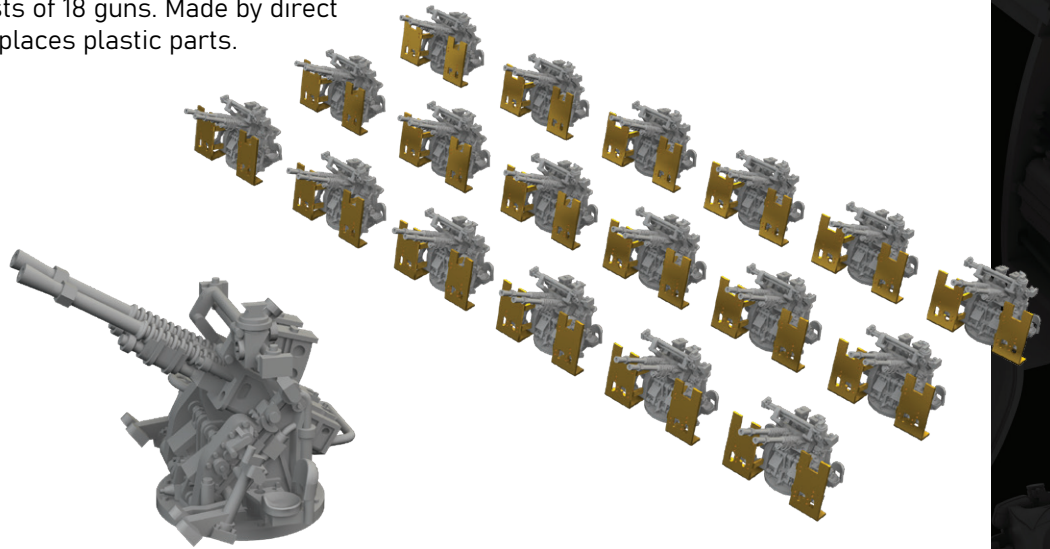

644272 Gannet AS.1/AS.4 LööKplus 1/48 Airfix

Collection of 3 sets for Gannet AS.1 or AS.4 in 1/48 scale. Recommended kit: Airfix

- LööK set (pre-painted Brassin dashboard & Steelbelts)
- TFace painting mask
- undercarriage wheels

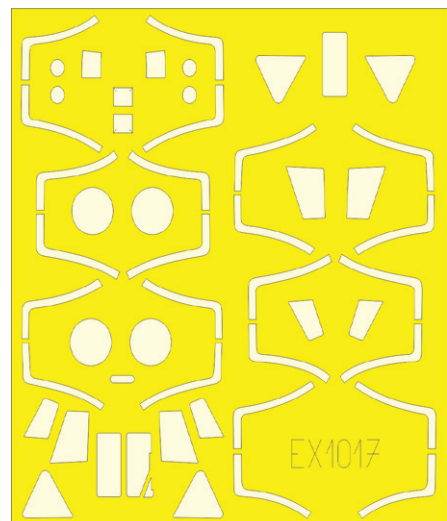
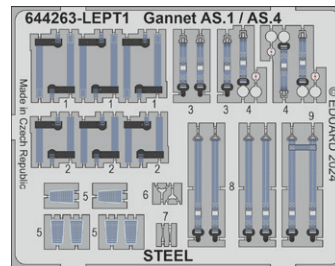

674008 Bf 109G-2 LööKplus 1/72 Eduard

Collection of 3 sets for Bf 109G-2 in 1/72 scale.
Recommended kit: Eduard

- LööK set (pre-painted Brassin dashboard & Steelbelts)
- gun barrels
- propeller

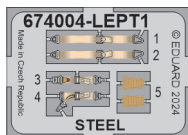

Löökt



674009 Bf 109G-4 LööKplus 1/72 Eduard

Collection of 3 sets for Bf 109G-4 in 1/72 scale.
Recommended kit: Eduard

- LööK set (pre-painted Brassin dashboard & Steelbelts)
- gun barrels
- propeller



Löökt



SIN648126 P-38J engines 1/48 Tamiya

Collection of 3 sets for P-38J in 1/48 scale.
Recommended kit: Tamiya

- left engine
- right engine
- turbochargers

All sets included in this BIG SIN are available separately,
but with every BIG SIN set you save up to 30 %.

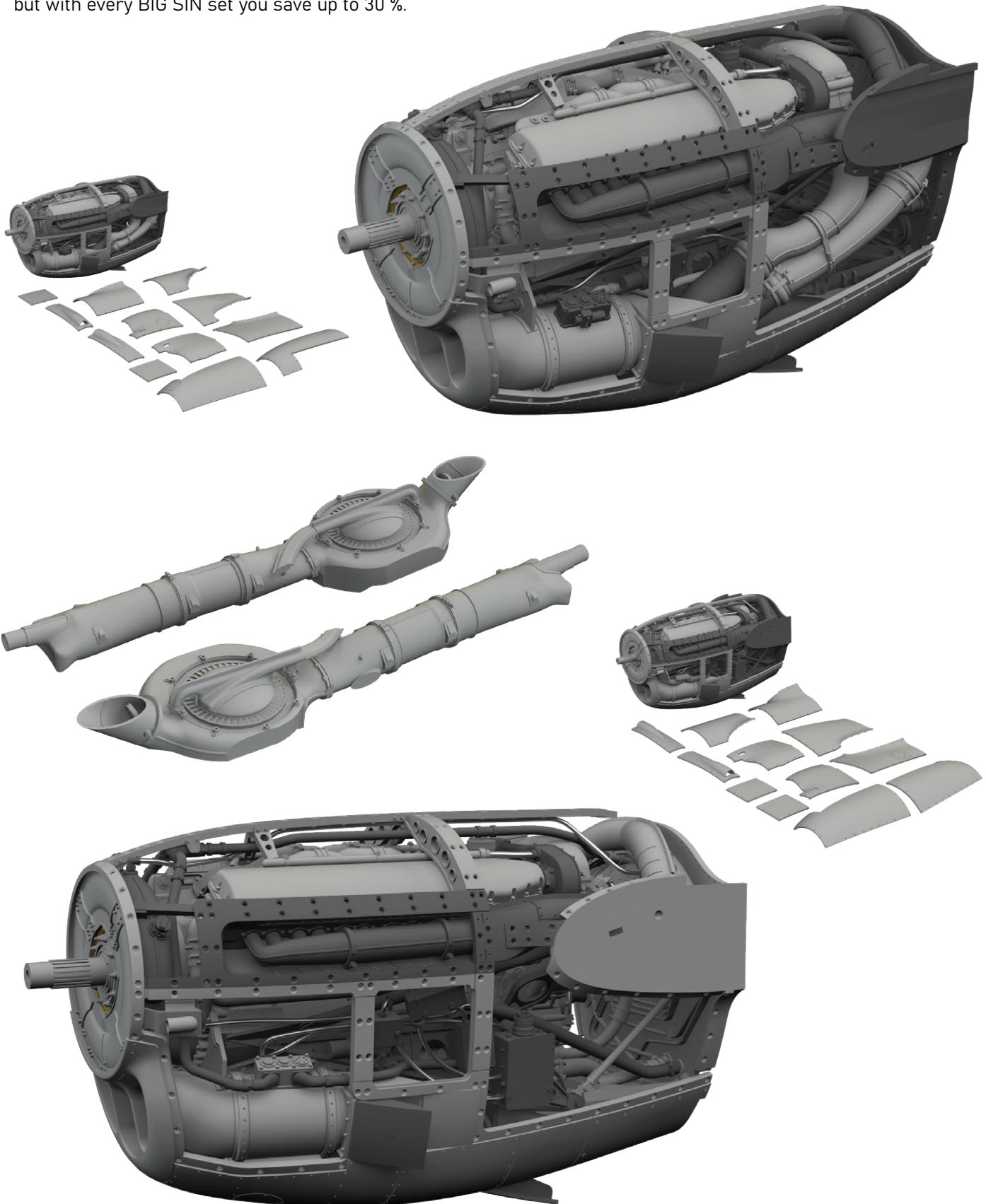

SIN67224 F-35A armament 1/72 Tamiya

Collection of 5 sets for F-35A in 1/72 scale.
Recommended kit: Tamiya

- GBU-12
- AIM-120C AMRAAM
- AIM-9X
- AIM-132 ASRAAM
- GBU-31(V)3/B JDAM

All sets included in this BIG SIN are available separately,
but with every BIG SIN set you save up to 30 %.

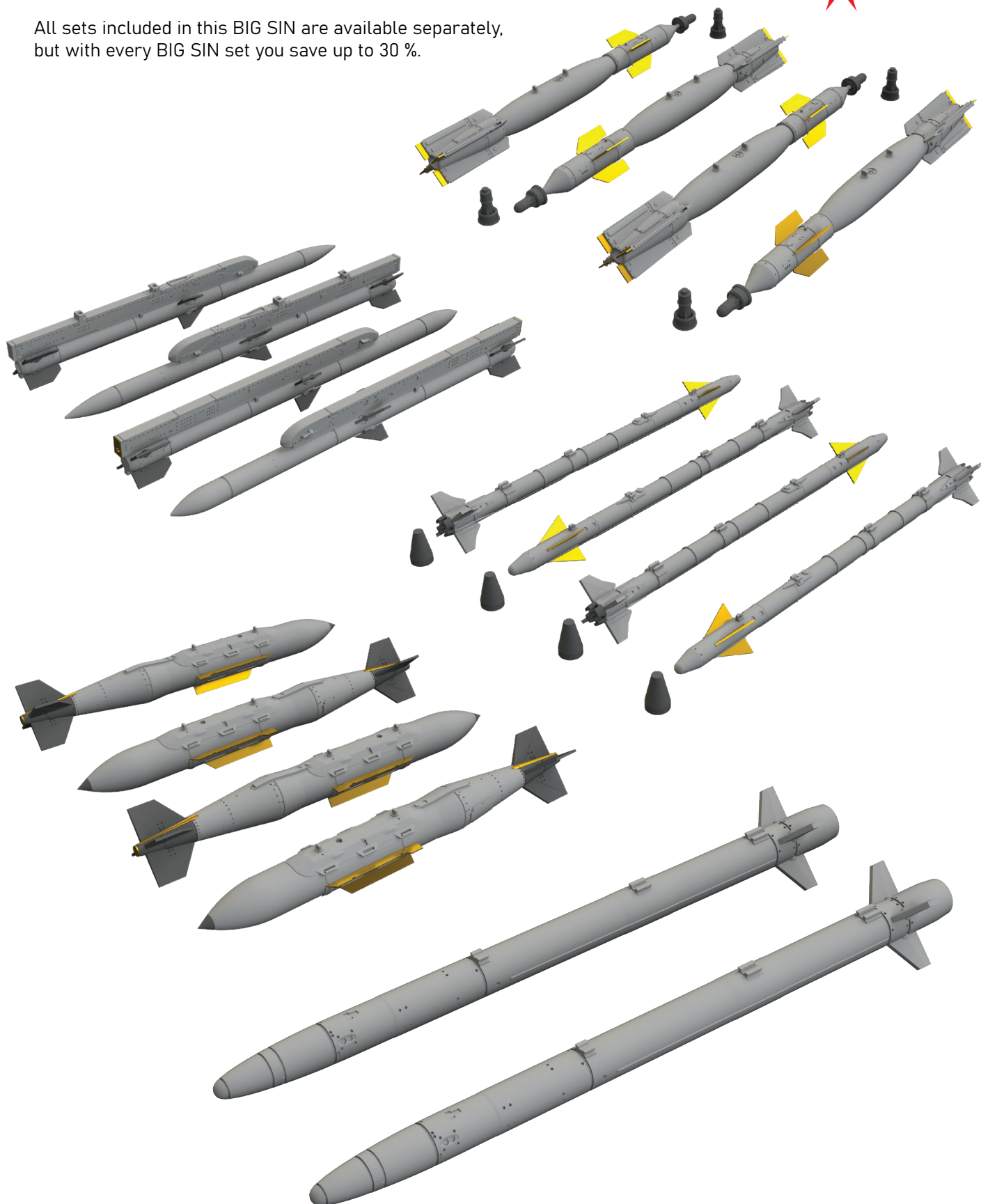

BIG49406 F-35B 1/48 Tamiya

- 49103 Remove Before Flight STEEL
- 491420 F-35B 1/48
- FE1421 F-35B seatbelts STEEL 1/48
- EX1011 F-35B 1/48

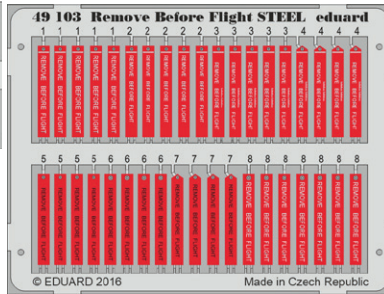
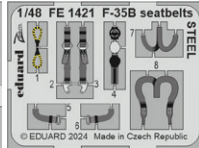
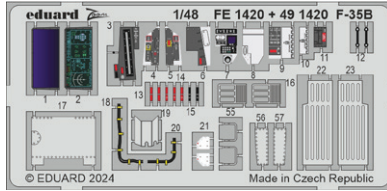
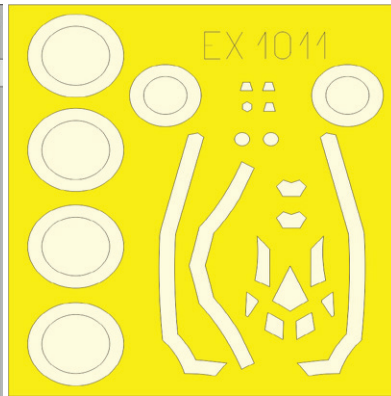
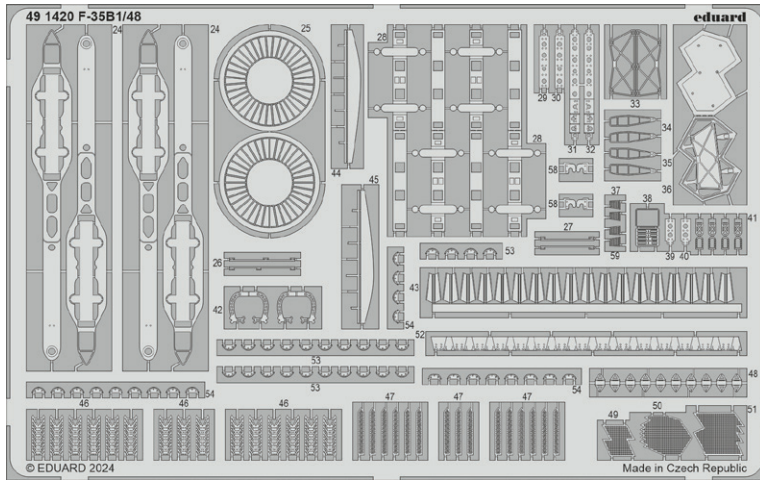

BIG49407 Gannet AS.1 1/48 Airfix

- 491424 Gannet AS.1 1/48
- FE1426 Gannet AS.1/AS.4 seatbelts STEEL 1/48
- EX1016 Gannet AS.1/AS.4 1/48

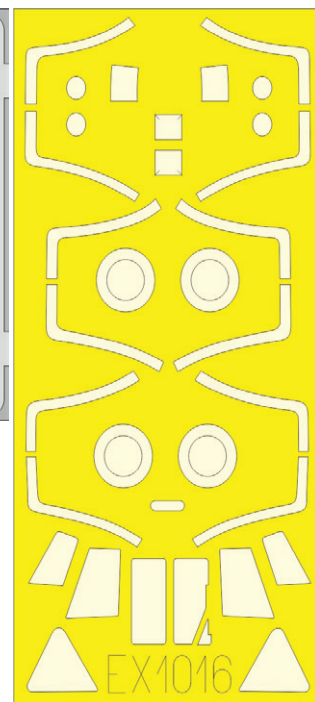
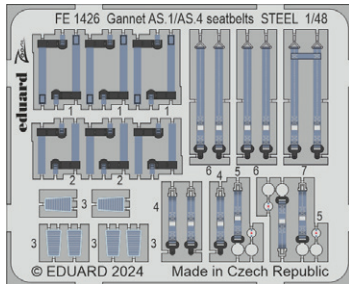
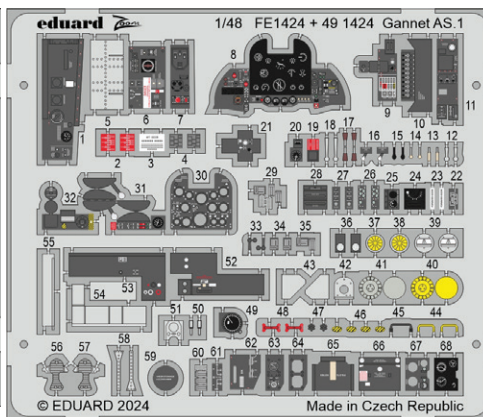
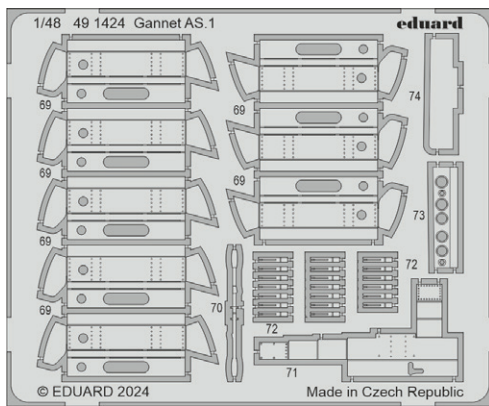

BIG49408 Gannet AS.4 1/48 Airfix

- 491425 Gannet AS.4 1/48
- FE1426 Gannet AS.1/AS.4 seatbelts STEEL 1/48
- EX1016 Gannet AS.1/AS.4 1/48

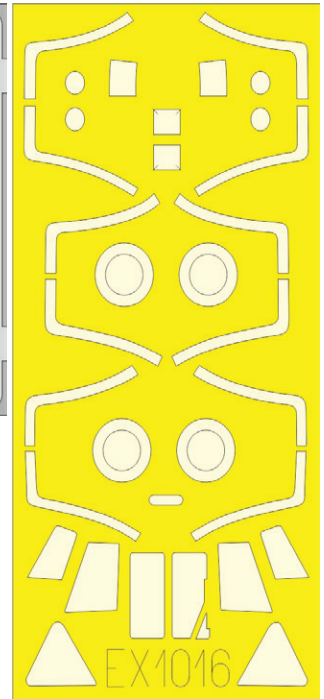
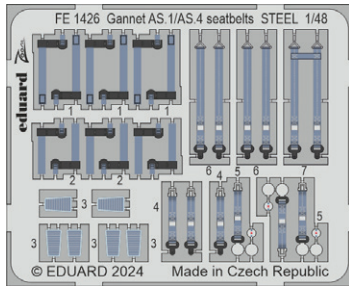
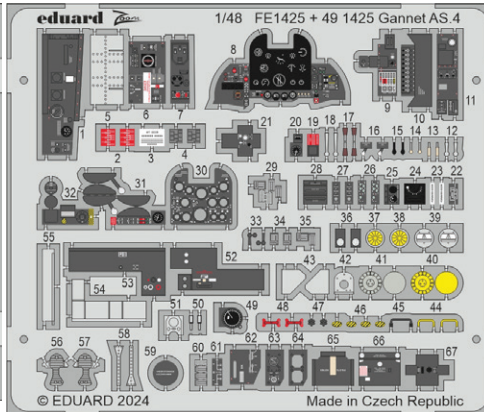
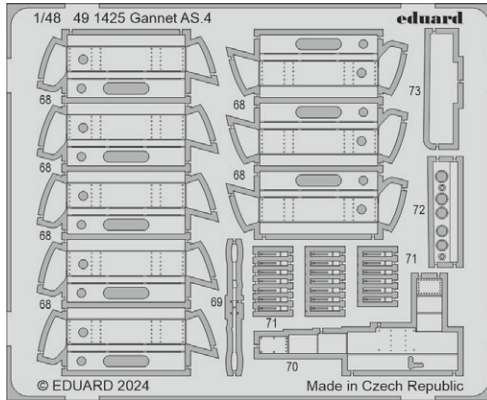

BIG49409 Hurricane Mk.IIb 1/48 Arma Hobby

- 491422 Hurricane Mk.IIb 1/48
- FE1423 Hurricane Mk.IIb seatbelts STEEL 1/48
- EX1014 Hurricane Mk.IIb 1/48

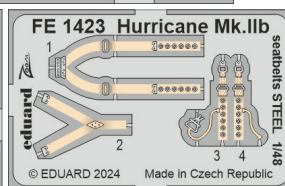
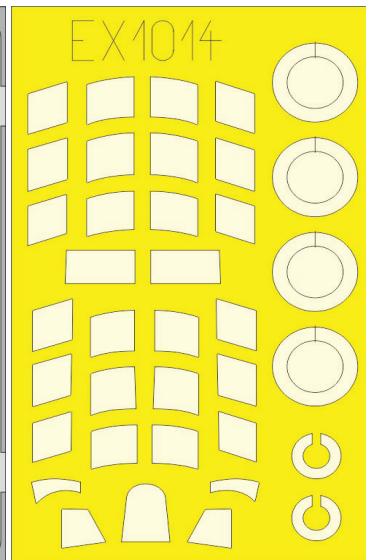
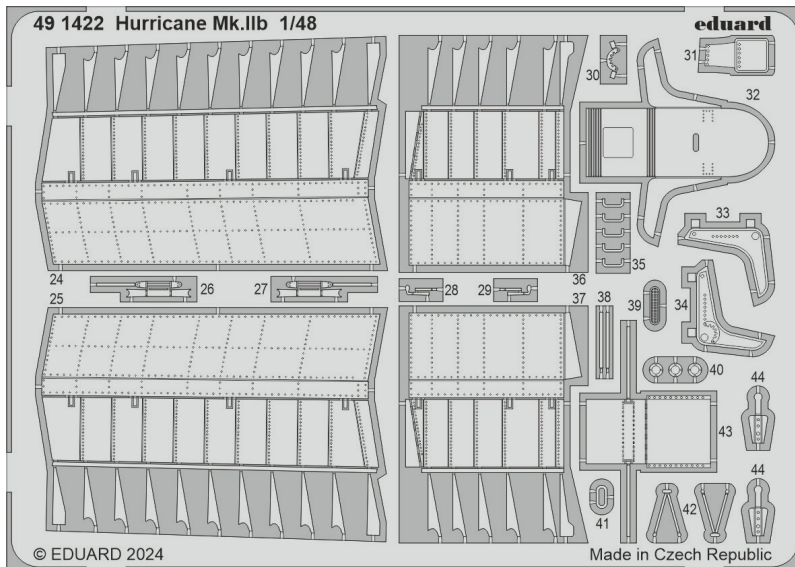



GUSTAV Pt.2

The famous WWII German fighter Bf 109G-6 and G-14 in the service with German, Finnish, Italian and Hungarian units all over Europe

#2145

- ✦ The premiere of the new Eduard design and tooling
- ✦ Photo-etched and pre-painted parts for the finest detail
- ✦ Die cut masks for easy painting
- ✦ Decals for 10 marking options

APRIL RELEASE

Option to purchase a separate set of Overtrees plastic parts., #70160X

www.eduard.com



Bf 109G-6/R6, WNr. 160303, Hptm. Friedrich Eberle, CO of III./JG 1, Volkel, the Netherlands, November 1943 - January 1944

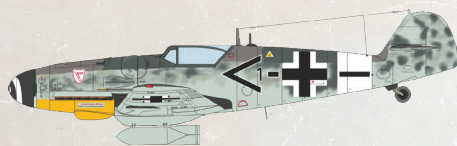

Bf 109G-6/R1, Lt. Max-Bruno Fischer, Stab II./JG 3, Evreux-Fauville, France, June 1944



Bf 109G-14, WNr. 782205, Lt. Antal Szebeni, 101/5. Vadászszázad MKHL, Börgönd, Hungary, October 1944



Bf 109G-6, Lt. Anton Hafner, CO of 10./JG 51, Tilsit-East, the Soviet Union, August 1944

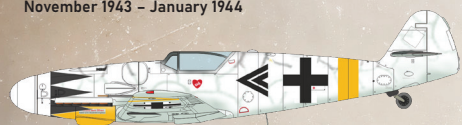

Bf 109G-14, Hptm. Erich Hartmann, CO of I./JG 53, Veszprém, Hungary, February 1945



Bf 109G-6, WNr. 165267, Majuri Eino Luukkanen, 1/HleLv 34, Taipalsaari airfield, Finland, July 1944



Bf 109G-14, Oblt. Rolf Schlegel, 10./JG 4, Jüterbog-Damm, Germany, March 1945



Bf 109G-14, WNr. 465437, Hptm. Franz Dörr, CO of III./JG 5, Gossen, Norway, May 1945



Bf 109G-14/U4, WNr. 512382, Lt. Horst Schlick, 4./JG 77, Schönwalde, Germany, November 1944



Bf 109G-14, WNr. 464380, Maggiore Mario Bellagambi, CO of 5ª Squadriglia, 2° Gruppo Caccia ANR, Osoppo, Italy, March 1945