

INFORMATION FOR DISTRIBUTORS

MAY 2024

Dear friends,

I would like to inform you about new releases coming up in May 2024.

THE KITS

The new kits for May were chosen in connection with the upcoming 80th anniversary of the Allied invasion of Normandy as part of Operation Overlord.

The main new release in May will be the premiere of the P-51B Mustang kit in 1/48 scale, which we have prepared as a Dual Combo in the Limited Edition under the title OVERLORD: D-DUAL MUSTANGS / P-51B MUSTANG DUAL COMBO 1/48. This release is eagerly anticipated by the customer community. A selection of decals allows for the construction of two out of the nine American and one British aircraft from the Normandy landings and subsequent operations during June 1944. The 4th, 352nd, 354th, 355th, 357th, 361st, and 363rd Fighter Groups will be represented with brightly colored machines from the summer of 1944. The selection includes the legendary „Salem Representative“ machine flown by Lt. Ralph K. „Kid“ Hofer of the 334th FS, 4th FG, and the RAF is represented by the famous aircraft flown by S/Ldr Eugeniusz „Dziubek“ Horbaczewski of No. 315 (Polish) Squadron. The kit also includes masks and pre-painted photoetched parts.

Alongside this kit, we are releasing an extended version, the Royal Class P-51B MUSTANG DUAL COMBO 1/48 with catalogue number R0019. It is not part of our regular stock and is available only in pre-sale, to which we have reached out to our partners in the past few days. Ordering the Royal Class edition at a later date will not be possible as part of restocking.

The P-51B stands out as one of the commercial highlights of this year. It is a well-designed and manufactured kit of a famous aircraft type, brimming with colorful schemes of renowned warplanes and the tales of their pilots. Consequently, it represents one of the few exceptional commercial opportunities. We're confident that you're already aware of this and won't let this opportunity slip by!

The other two kits that coincide with the 80th anniversary of Operation Overlord are the Mk.IXc Late Spitfires in the Weekend edition. Their box art will be linked to the battles over Normandy in June 1944, and each kit will offer decals for four machines. The first Spitfire will be released in 1/48 scale, featuring on its box art a New Zealander - P/O Johnnie Houlton of No. 485 Squadron. The decals will also include options for the aircraft of W/Cdr Johnnie Johnson, the Spitfire of French fighter ace Cpt. M. Boudier, or the plane of the most successful Greek fighter pilot, S/Ldr J. Plagis.

The second Spitfire Mk.IXc kit, this time in 1/72 scale, has been prepared with an invasion theme. It will feature box art depicting the legendary commander of No. 144 Wing RAF, W/Cdr Johnnie Johnson. The other three decal variants will also be the same as those offered in the 1/48th scale kit mentioned above.

The 80th anniversary of Operation Overlord presents another exceptional trading opportunity. In addition to the new releases mentioned above, we offer several other Invasion-themed items in our kit selection. Consider taking advantage of them during this spring and summer, when the anniversary of the Invasion will be in the spotlight, not only

for modelers. Below is a list of Operation Overlord-themed kits:

8281 Spitfire Mk. IXc late version 1/48 ProfiPACK

82122 Tempest Mk. V series 2 1/48 ProfiPACK

84172 P-51D-5 1/48 Weekend

84183 Spitfire Mk.IXc 1/48 Weekend

84195 Tempest Mk. V Series 1/48 Weekend

7466 Spitfire Mk. IXc 1/72 Weekend

The Bloody Hundredth 1943, B-17F 1/48

This time, we would like to inform you about a kit set to be released in August 2024. Given that it will be a very specific limited edition, we seek your feedback on the estimated number of kits you will order.

In collaboration with HKM and the 100th Bomb Group Foundation, we will be producing a 1/48th scale B-17F bomber kit focusing on the legendary unit nicknamed „The Bloody Hundredth.“ To achieve this, we are working with HKM to develop a new injection mold that will enable us to create nose variants not previously available in the kit. This enhancement will allow us to include the markings of the legendary machines that served with the unit in 1943:

Rosie's Riveters, B-17F-120-BO, 42-30758, LD-W

Piccadilly Lily, B-17F-30-VE, 42-5864, EP-A

Hard Luck!, B-17F-55-DL, 42-3413, LN-V

Sunny II, B-17F-120-BO, 42-30796, EP-K / EP-J

Alice from Dallas, B-17F-30-VE, 42-5867, LN-O

Skipper, B-17F-45-DL, 42-3307, EP-N

Horny, B-17F-40-VE, 42-5957, XR-D

The kit will come complete with masks, photo-etched parts, and brassin parts, as well as a poster by artist Piotr Forkasiewicz.

We will be reaching out to you in the next few days to inquire about your anticipated orders for this item in a separate mailing. By the end of March, we will place orders for the plastic parts from HKM and determine the size of the edition, i.e., the number of kits to be issued. Since this is a substantial and costly investment, the edition size will be determined strictly by pre-order status. Consequently, those who do not pre-order will likely not have the opportunity to order the item. We therefore ask you to carefully consider your anticipated sales of this kit and be prepared to inform us of your pre-orders next week. Thank you for your understanding and cooperation!

BRASSIN

In May, the P-51B Mustang in 1/48 scale will be the focal point of our accessories. We will release three sets of wheels, two sets of exhausts, a seat, bronze landing gear legs, and gun wells in the wing. Additionally, a LööK set will be available for the P-51B.

For Kinetic's F-16C kit in May, we have prepared two sets of cockpits for the Block 52 variant, as their designs have been gradually evolving, along with a set for the landing gear well. A set of two seats for the L-39 kit in 1/72 scale (Eduard) will also be released. This set is aimed at significantly enhancing the cockpit appearance of this older kit.

Furthermore, we have developed a set of wheels and a LööK

set for the 1/48th scale Gannet kit by Airfix.

In addition to these releases, LööK sets for the 109G-6 and Bf 109F in 1/72 scale kits (Eduard) will be available in May.

Finally, LööKplus sets have been designed in 1/48 scale for the Fw 190A-7 (Eduard) and the F-35B kit by Tamiya.

ACCESSORY SETS - PHOTO-ETCHED PARTS, MASK AND DECALS

Italeri has reintroduced the CR-32 fighter biplane kit in 1/72 scale. Consequently, we are reissuing our previously released and sold-out photo-etched sets. A similar situation arises with the re-release of the MC.200 fighter aircraft by the same manufacturer, but this time in 1/48 scale. However, we are simplifying some of the parts to enhance assembly convenience.

In May, for the Tamiya 1/48 scale kit of FM-1 carrier fighter, we have prepared two Zoom sets, a comprehensive set and a set of flaps.

Additionally, for the 1/48 scale Buccaneer S.2B kit by Airfix, which depicts the aircraft used in the Gulf War, we have prepared a set of photo-etched parts.

Furthermore, for the Sd.Kfz. 251/18 Ausf. A in 1/35 scale by ICM, we will release a set of photo-etched parts, which will include some parts designed as 3D decals of the Space series.

Lastly, for the 1/350 scale kit of the escort aircraft carrier USS Sangamon CVE-26 by Trumpeter, we have the first set of photo-etched parts ready for May.

The Space set is, of course, ready for May in 1/48 scale for P-51B/C (Eduard). In this scale, we will also offer sets for the Buccaneer S.2B and Buccaneer S.2B Gulf War (Airfix), FM-1 (Tamiya), F-14A (GWH), and MC.200 (Italeri). There is one set in 1/72 scale for May, designed for Italeri's CR.32 kit.

In addition to the standard range of masks, three sets of national insignia masks for the FM-1 kit in 1/48 scale by Tamiya will also be available for May. Masks for the standard American insignia will also be available in 1/48 scale for the P-51B/C (Eduard) kit.

In the Eddie the Riveter 3D decal line, we have a total of four sets for May. In 1/32 scale, these will be the surface details and the circular rows of rivets. In 1/48 and 1/72 scale, there are also circular rows of rivets.

SHIPPING OF APRIL ITEMS AND PRE-ORDERS OF MAY NEW RELEASES

As is customary each month, I kindly request that you submit your **pre-orders for the May releases, preferably by Tuesday, April 2, 2024**. Based on your pre-orders, we will determine the quantity of items to produce. Please note that **if we do not receive your pre-order, we cannot guarantee the availability of all items** for your future orders, particularly for LIMITED series items.

Shipments of the March new releases are already underway. Should you require assistance with marketing materials, please do not hesitate to contact me directly.

Thank you for your attention and continued support!

Jan Bobek

Product previews are subject of change.

Instruction sheets,
more pictures and information
can be found on www.eduard.com

This leaflet can be downloaded from www.eduard.com

eduard

PLASTIC KITS



11181 **OVERLORD: D-DAY MUSTANGS Dual Combo**
1/48 Limited

DETAIL



84199 **Spitfire Mk.IXc late**
1/48 Weekend

DETAIL



7473 **Spitfire Mk.IXc late**
1/72 Weekend

DETAIL

MASKS

| | | | |
|--------|--|------|------------------|
| EX1029 | FM-1 | 1/48 | Tamiya |
| EX1030 | FM-1 TFace | 1/48 | Tamiya |
| EX1031 | FM-1 US national insignia | 1/48 | Tamiya |
| EX1032 | FM-1 US national insignia w/ red outline | 1/48 | Tamiya |
| EX1033 | FM-1 British national insignia | 1/48 | Tamiya |
| EX1034 | Buccaneer S.2B | 1/48 | Airfix |
| EX1035 | Buccaneer S.2B TFace | 1/48 | Airfix |
| EX1036 | P-51B/C framed canopy TFace | 1/48 | Eduard |
| EX1037 | P-51B/C Malcolm Hood canopy TFace | 1/48 | Eduard |
| EX1038 | P-51B/C US national insignia | 1/48 | Eduard |
| EX1039 | MC.200 TFace | 1/48 | Italeri |
| EX1040 | F-14A windshield TFace | 1/48 | Great Wall Hobby |
| CX662 | CR.32 | 1/72 | Italeri |

SPACE

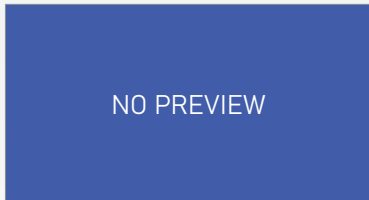

3DL48174 FM-1 SPACE
1/48 Tamiya
(2 parts)

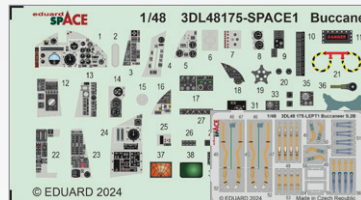

3DL48175 **Buccaneer S.2B SPACE**
1/48 Airfix
(2 parts)

DETAIL

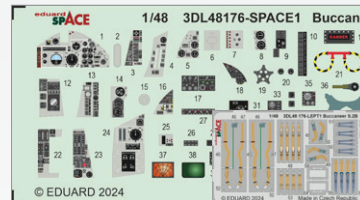

3DL48176 **Buccaneer S.2B Gulf War SPACE**
1/48 Airfix
(2 parts)

DETAIL

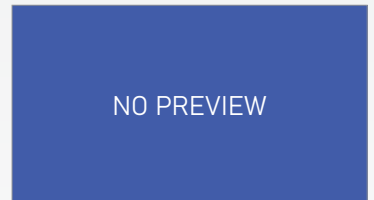

3DL48177 P-51B/C SPACE
1/48 Eduard
(2 parts)

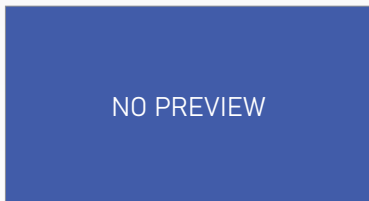

3DL48178 F-14A SPACE
1/48 Great Wall Hobby
(2 parts)

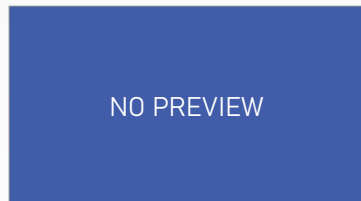

3DL48179 MC.200 SPACE
1/48 Italeri
(2 parts)

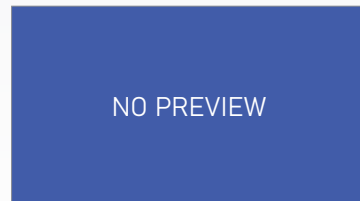

3DL72031 CR.32 SPACE
1/72 Italeri
(2 parts)

PHOTO-ETCHED SETS



53309 USS Sangamon CVE-26
1/350 Trumpeter
(1 part)

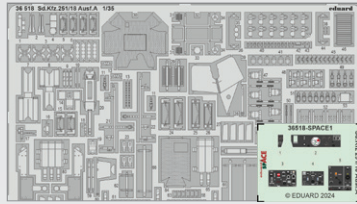

36518 Sd.Kfz. 251/18 Ausf. A
1/35 ICM
(1 PE part and SPACE part)

DETAIL

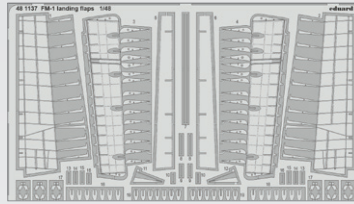

481137 FM-1 landing flaps
1/48 Tamiya
(1 part)

DETAIL

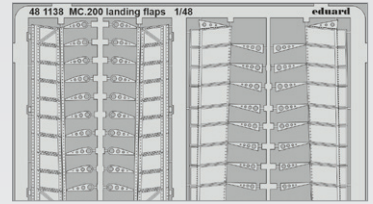

481138 MC.200 landing flaps
1/48 Italeri
(1 part)

DETAIL

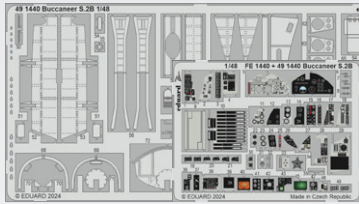

491440 Buccaneer S.2B
1/48 Airfix
(2 parts)

DETAIL

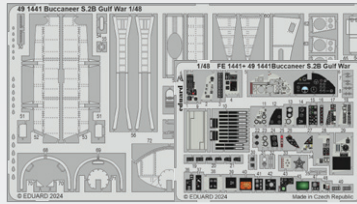

491441 Buccaneer S.2B Gulf War
1/48 Airfix
(2 parts)

DETAIL

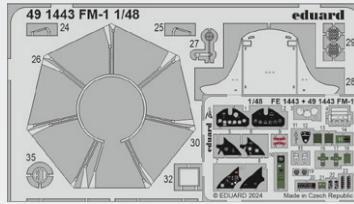

491443 FM-1
1/48 Tamiya
(2 parts)

DETAIL

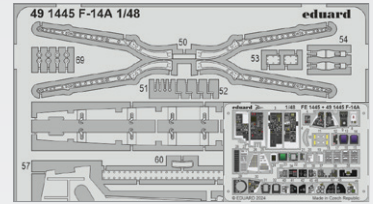

491445 F-14A
1/48 Great Wall Hobby
(2 parts)

DETAIL

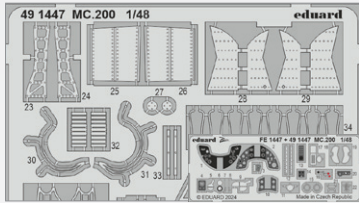

491447 MC.200
1/48 Italeri
(2 parts)

DETAIL

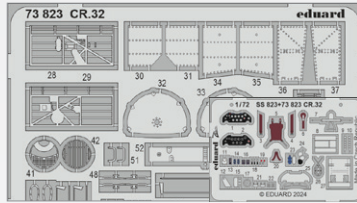

73823 CR.32
1/72 Italeri
(2 parts)

DETAIL

PHOTO-ETCHED SETS

ZOOM

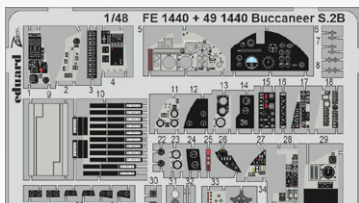

FE1140 Buccaneer S.2B
1/48 Airfix
(1 part)

DETAIL



FE1441 Buccaneer S.2B Gulf War
1/48 Airfix
(1 part)

DETAIL

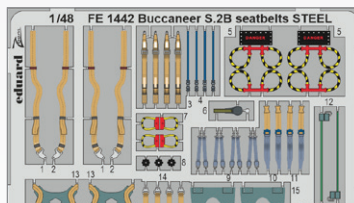

FE1442 Buccaneer S.2B seatbelts
STEEL 1/48 Airfix
(1 part)

DETAIL

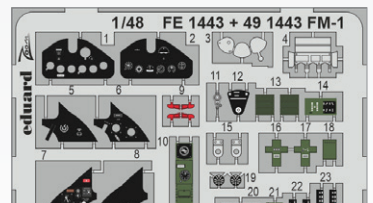

FE1443 FM-1
1/48 Tamiya
(1 part)

DETAIL

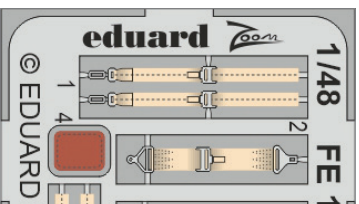

FE1444 FM-1 seatbelts STEEL
1/48 Tamiya
(1 part)

DETAIL

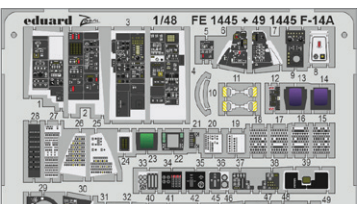

FE1445 F-14A
1/48 Great Wall Hobby
(1 part)

DETAIL

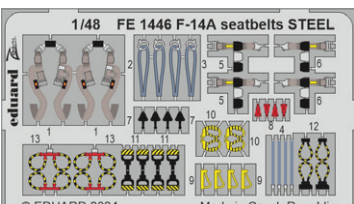

FE1446 F-14A seatbelts STEEL
1/48 Great Wall Hobby
(1 part)

DETAIL

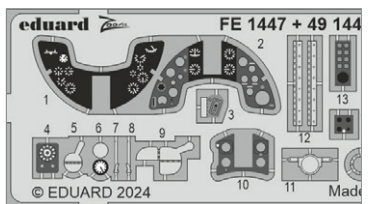

FE1447 MC.200
1/48 Italeri
(1 part)

DETAIL

PHOTO-ETCHED SETS

ZOOM

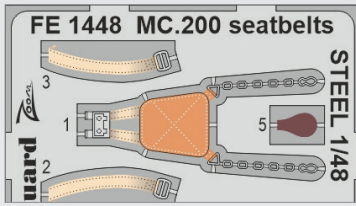

FE1448 MC.200 seatbelts STEEL
1/48 Italeri
(1 part)

DETAIL

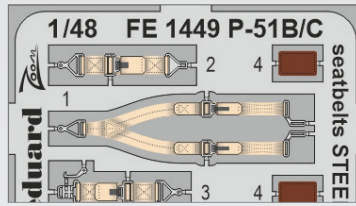

FE1449 P-51B/C seatbelts STEEL
1/48 Eduard
(1 part)

DETAIL

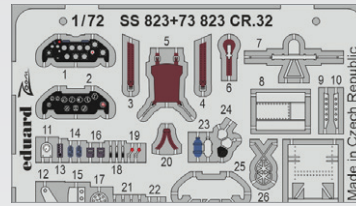

SS823 CR.32
1/72 Italeri
(1 part)

DETAIL

BIG ED SETS



BIG5371 USS Iowa
BB-61 1/350
Hobby Boss

DETAIL



BIG49403 Ki-21-I
1/48 ICM

DETAIL

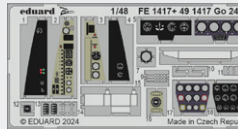

BIG49404 Go 244B
1/48 ICM

DETAIL

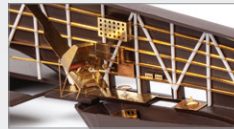

BIG49405 SM.79
1/48 Eduard

DETAIL

EDDIE THE RIVETER

NO PREVIEW

ER32004 Surface
panels 1/32

NO PREVIEW

ER32005 Single radial
rows 1/32

NO PREVIEW

ER48010 Single radial
rows 1/48

NO PREVIEW

ER72005 Single radial
rows 1/48

BRASSIN



644263 Gannet AS.1/AS.4 LööK 1/48 Airfix

DETAIL

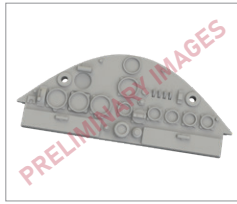

644266 Bf 108 LööK 1/48 Eduard

DETAIL

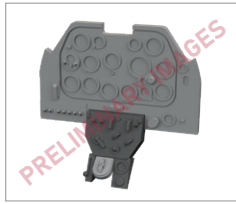

644268 P-51B/C LööK 1/48 Eduard

DETAIL

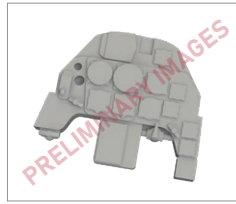

674006 Bf 109G-6 LööK 1/72 Eduard

DETAIL

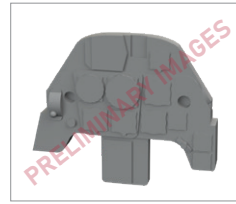

674007 Bf 109F LööK 1/72 Eduard

DETAIL

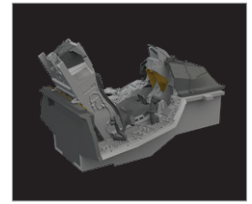

648972 F-16C Block 52 till 1996 cockpit PRINT 1/48 Kinetic

DETAIL

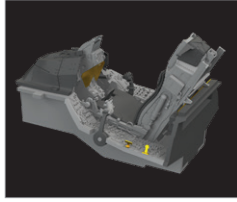

648973 F-16C Block 52 from 1997 cockpit PRINT 1/48 Kinetic

DETAIL



648984 F-16C wheel bays late PRINT 1/48 Kinetic

DETAIL



648986 P-51B/C wheels diamond tread 1/48 Eduard

DETAIL

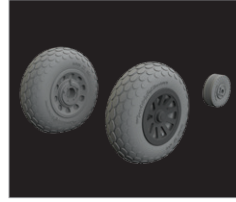

648987 P-51B/C wheels oval tread 1/48 Eduard

DETAIL



648988 P-51B/C wheels cross tread 1/48 Eduard

DETAIL



648992 P-51B/C exhaust stacks 1/48 Eduard

DETAIL



648993 P-51B/C exhaust stacks w/fairing 1/48 Eduard

DETAIL



648994 P-51B/C undercarriage legs BRONZE 1/48 Eduard

DETAIL

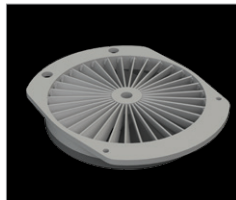

648995 F-35B lift fan PRINT 1/48 Tamiya

DETAIL



648996 Gannet wheels 1/48 Airfix

DETAIL

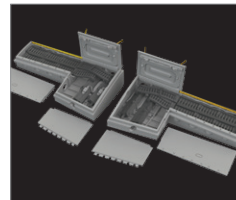

648997 P-51B/C gun bays PRINT 1/48 Eduard

DETAIL



6481002 P-51B/C seat Type 1 PRINT 1/48 Eduard

DETAIL

LööKplus



672357 L-39 ejection seats PRINT 1/72 Eduard

DETAIL

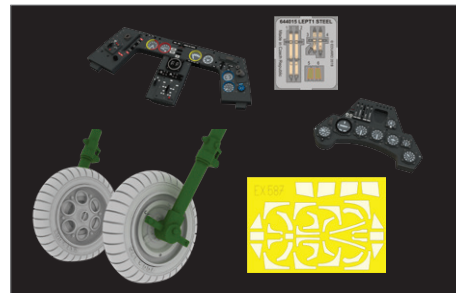

644243 Fw 190A-7 LööKplus 1/48 Eduard

DETAIL

LööKplus



644267 F-35B LööKplus 1/48 Tamiya

DETAIL

BIGSIN

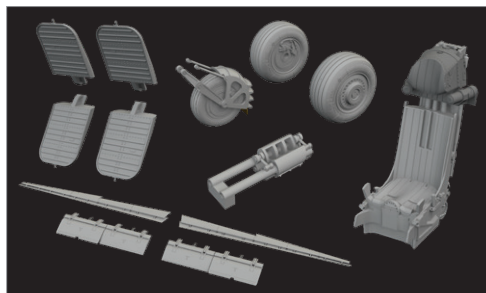

SIN648125 Su-25 1/48 Zvezda

DETAIL

BIGSIN

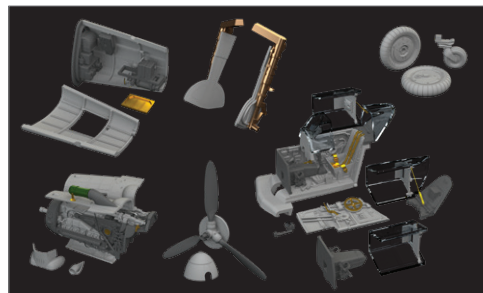

SIN67223 Bf 109G-6 1/72 Eduard

DETAIL

The Limited edition of the kit of the famous US fighter aircraft P-51B Mustang in 1/48 scale. The kit offers aircraft which took part in the operation Overlord. Marking selection covers American and British aircraft taking part during the D-Day and successive operations in June 1944

Dual Combo

1/48

BASIC INFO:

NAME: **OVERLORD: D-DAY MUSTANGS**

CAT. NO.: 11181

SCALE: 1/48

EDITION: Limited

CONTENTS:

SPRUES: Eduard

PE-SETS: Yes, pre-painted

PAINTING MASK: Yes

MARKING OPTIONS: 10

BRASSIN: No



RELATED PRODUCTS:

FE1449 P-51B/C seatbelts STEEL (PE-Set)

644268 P-51B/C LööK (Brassin)

648986 P-51B/C wheels diamond tread (Brassin)

648987 P-51B/C wheels oval tread (Brassin)

648988 P-51B/C wheels cross tread (Brassin)

648992 P-51B/C exhaust stacks (Brassin)

648993 P-51B/C exhaust stacks w/fairing (Brassin)

648994 P-51B/C undercarriage legs BRONZE (Brassin)

648997 P-51B/C gun bays PRINT (Brassin)

6481002 P-51B/C seat Type 1 PRINT (Brassin)

3DL48177 P-51B/C SPACE (3D Decal Set)

EX1036 P-51B/C framed canopy TFace (Mask)

EX1037 P-51B/C Malcolm Hood canopy TFace (Mask)

EX1038 P-51B/C US national insignia (Mask)

KIT PARTS

2xF>

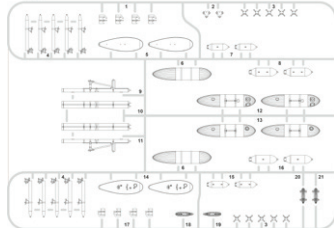

M>

2x

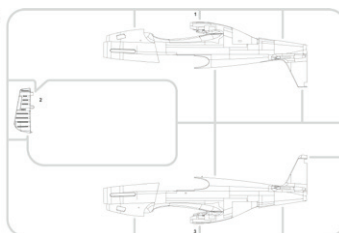

K>

2x



L>

2x

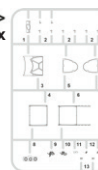

O>

2x

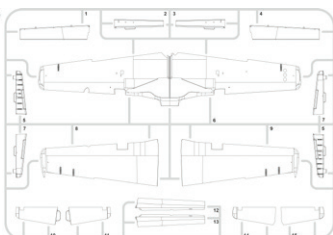

R>

2x

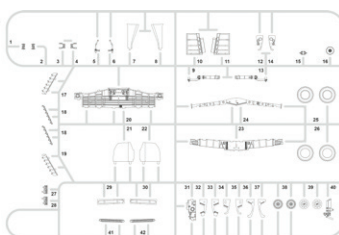

P>

2x

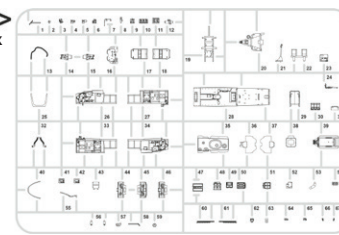

S>

2x

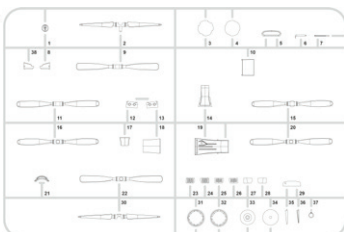

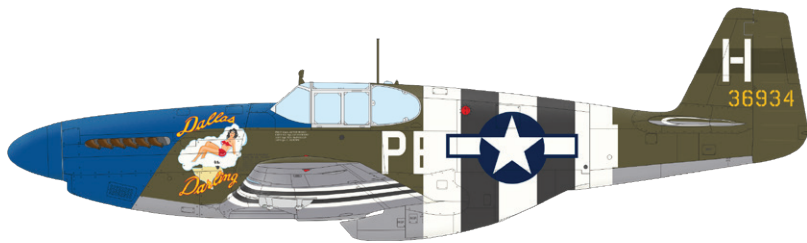

P51B-10-NA, s/n 43-6934, Cpt. Henry White, 328th FS, 352th FG, 8th AF, Bodney, Great Britain, June 1944

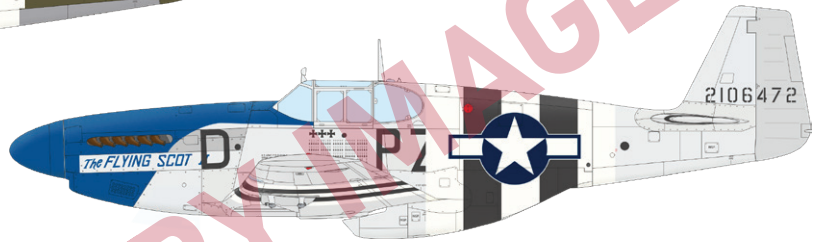

P51B-10-NA, s/n 42-106472, Lt. Carlton Fuhrman, 486th FS, 352th FG, 8th AF, Bodney, Great Britain, June 1944

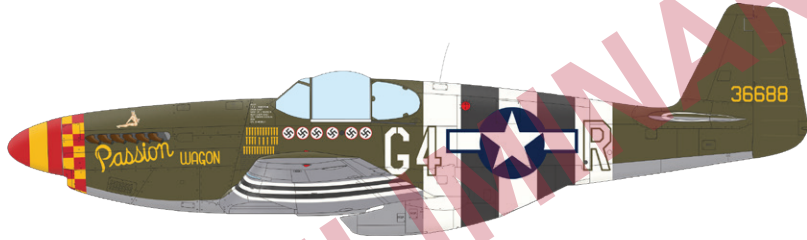

P51B-10-NA, s/n 43-6688, 1Lt. Arval Roberson, 362nd FS, 357th FG, 8th AF, Leiston, Great Britain, June 1944

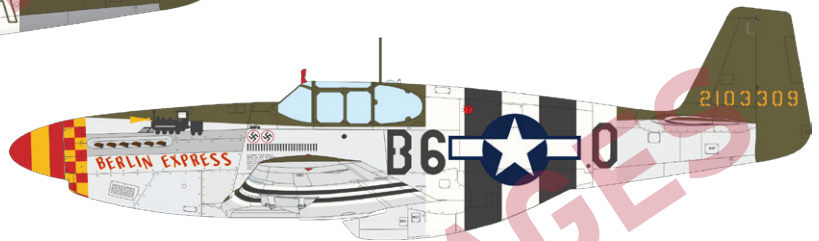

P51C-1-NT, s/n 42-103309, Lt. William B. Overstreet, 363rd FS, 357th FG, 8th AF, Leiston, Great Britain, June 1944

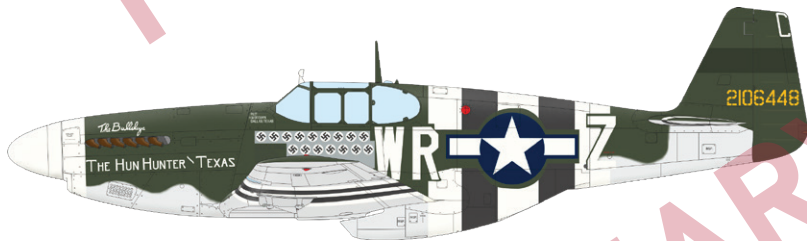

P51B-10-NA, s/n 42-106448, Cpt. Henry W. Brown, 354th FS, 355th FG, 8th AF, Steeple Morden, Great Britain, June 1944

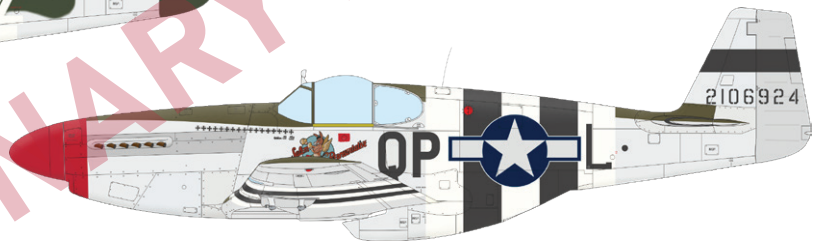

P51B-15-NA, s/n 42-106924, 2nd Lt. Ralph K. Hofer, 334th FS, 4th FG, 8th AF, Debden, Great Britain, June 1944

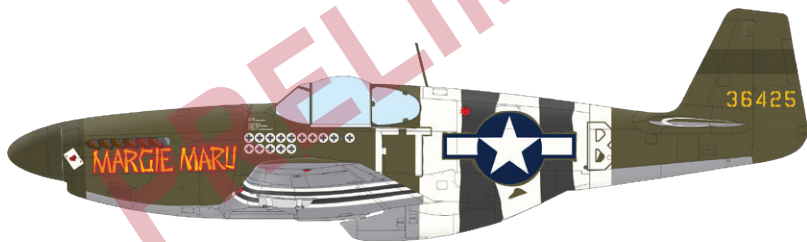

P51B-5-NA, s/n 43-6425, Maj. Jack T. Bradley, CO 353rd FS, 354th FG, 9th AF, A.2 Criqueville, France, June 1944

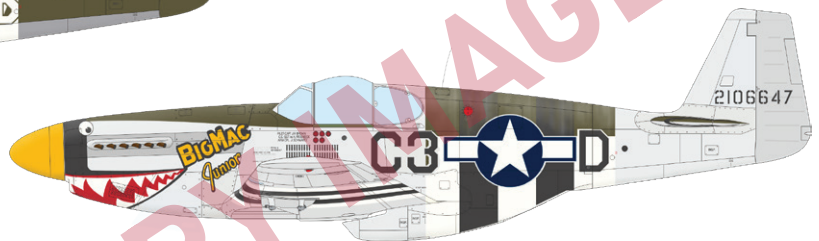

P51B-10-NA, s/n 42-106647, Capt. John R. Brown, 382nd FS, 363rd FG, 9th AF, Staplehurst, Great Britain, June 1944

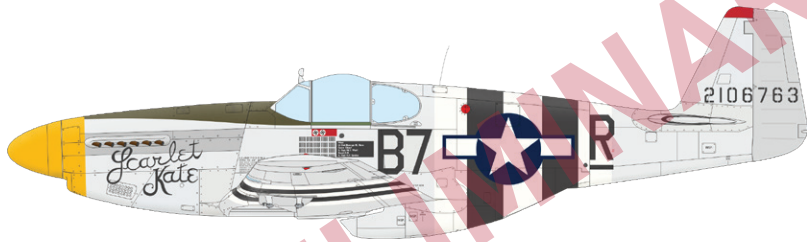

P51B-15-NA, s/n 42-106763, Capt. George R. Rew, 374th FS, 361st FG, 8th AF, Bottisham, Great Britain, June 1944

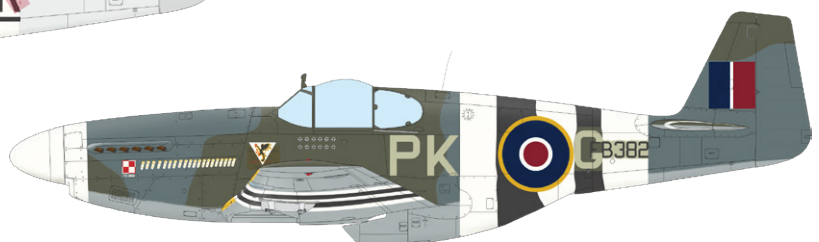

Mustang Mk.III, FB382, S/Ldr Eugeniusz Horbaczewski, No. 315 (Polish) Squadron, RAF Coolham, Great Britain, June 1944

The Weekend edition kit of British fighter aircraft Spitfire Mk.IXc late in 1/48 scale.

BASIC INFO:

NAME: **Spitfire Mk.IXc late**

CAT. NO.: 84199

SCALE: 1/48

EDITION: Weekend

CONTENTS:

SPRUES: Eduard

PE-SETS: No

PAINTING MASK: No

MARKING OPTIONS: 4

BRASSIN: No

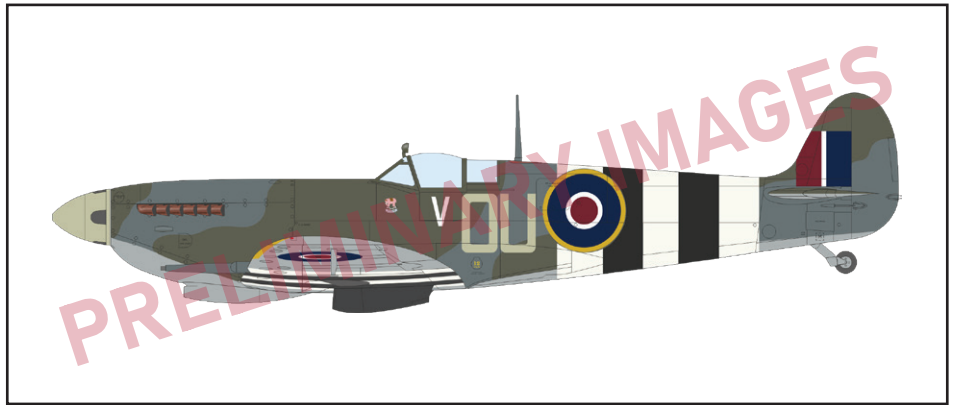

RELATED PRODUCTS:

- 49639 Spitfire Mk.IXc (PE-Set)
- 49674 Spitfire Mk.IXc late Weekend (PE-Set)
- FE840 Spitfire Mk.IX seatbelts STEEL (PE-Set)
- 644008 Spitfire Mk.IX late LööK (Brassin)
- 648100 Spitfire Mk.IX cockpit (Brassin)
- 648112 Spitfire Mk.IX engine (Brassin)
- 648113 Spitfire Mk.IX gun bay (Brassin)
- 648306 Spitfire Mk.IX top cowl late (Brassin)
- 648748 Spitfire Mk.IX landing flaps PRINT (Brassin)
- 3DL48029 Spitfire Mk.IXc late version SPACE (3D Decal Set)
- EX413 Spitfire Mk.IXc Weekend (Mask)

KIT PARTS

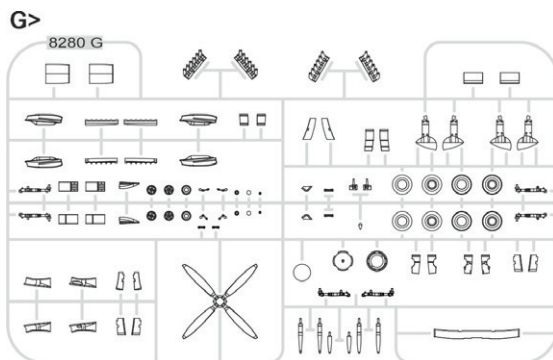
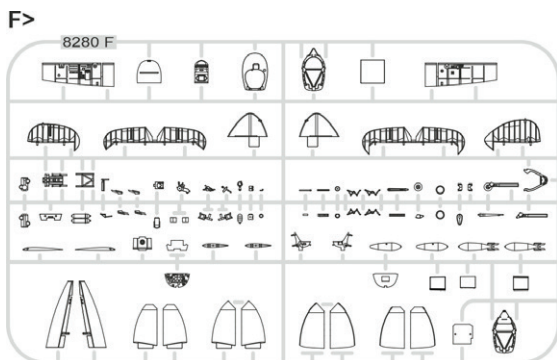
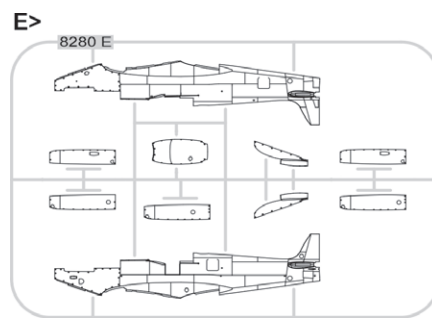
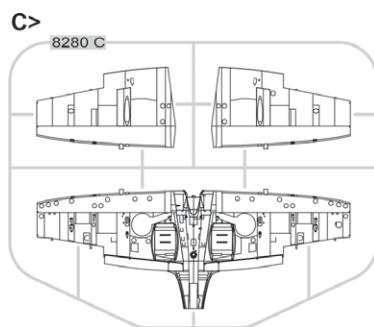

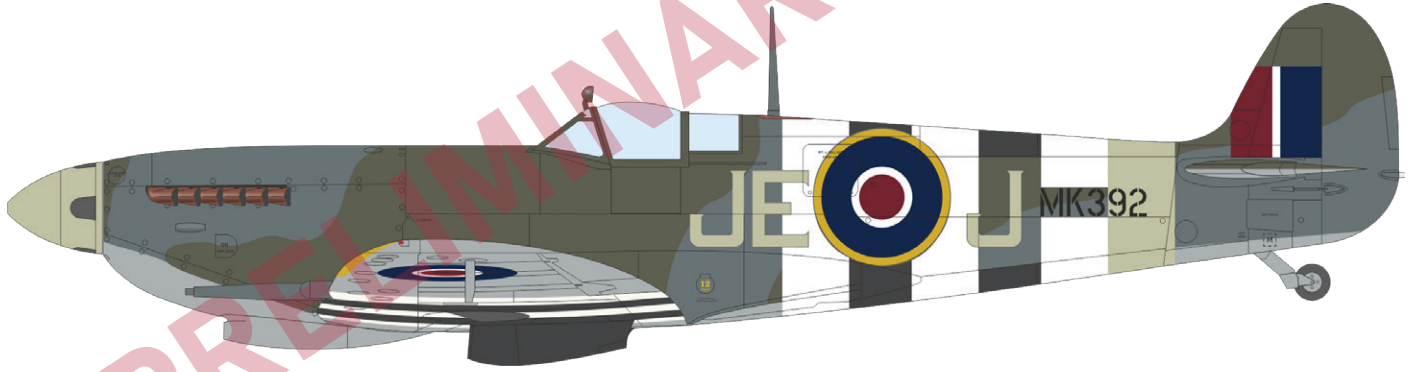
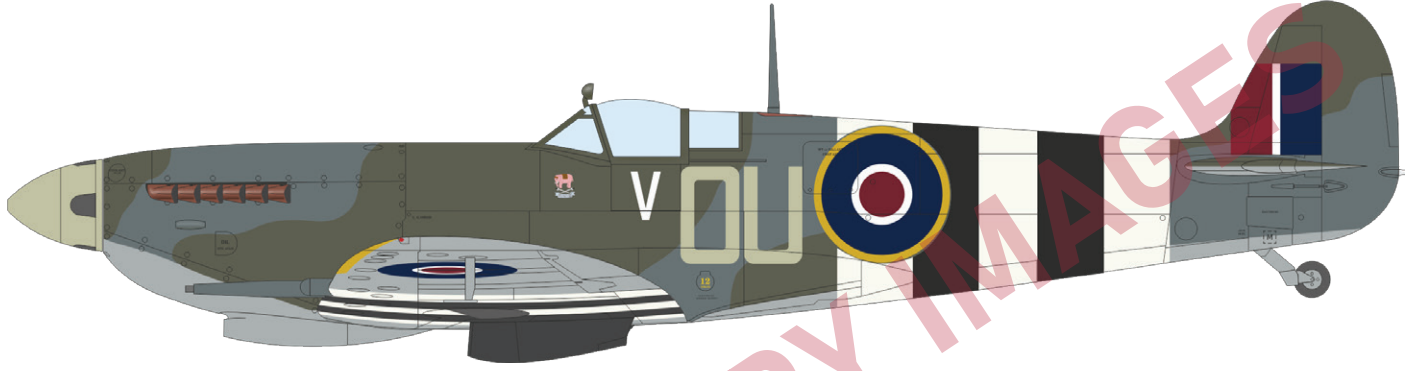

PRELIMINARY IMAGES

The Weekend edition kit of British fighter aircraft Spitfire Mk.IXc late in 1/72 scale.

BASIC INFO:

NAME: **Spitfire Mk.IXc late**

CAT. NO.: 7473

SCALE: 1/72

EDITION: Weekend

CONTENTS:

SPRUES: Eduard

PE-SETS: No

PAINTING MASK: No

MARKING OPTIONS: 4

BRASSIN: No

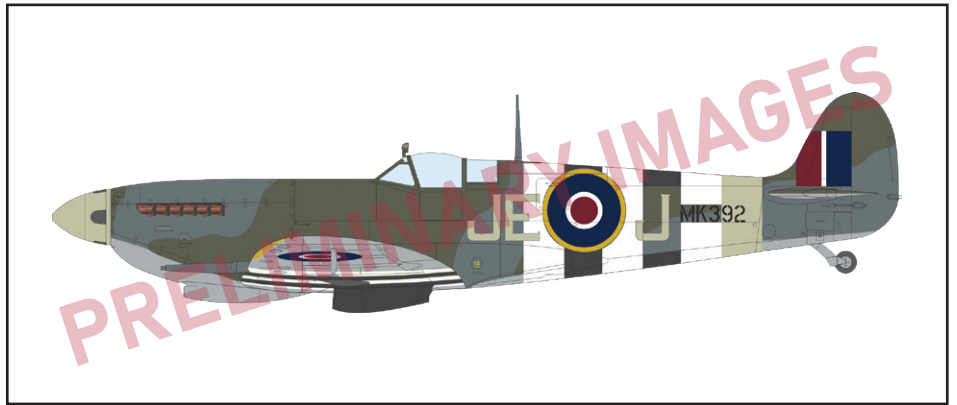

RELATED PRODUCTS:

SS597 Spitfire Mk.IX seatbelts STEEL (PE-Set)

SS651 Spitfire Mk.IX radiator grilles (PE-Set)

672112 Spitfire Mk.IX cockpit (Brassin)

672124 Spitfire Mk.IX top cowl late (Brassin)

672126 Spitfire Mk.IX engine (Brassin)

672134 Spitfire Mk.IX legs BRONZE (Brassin)

3DL72015 Spitfire Mk.IXc SPACE (3D Decal Set)

CX454 Spitfire Mk.IX (Mask)

KIT PARTS

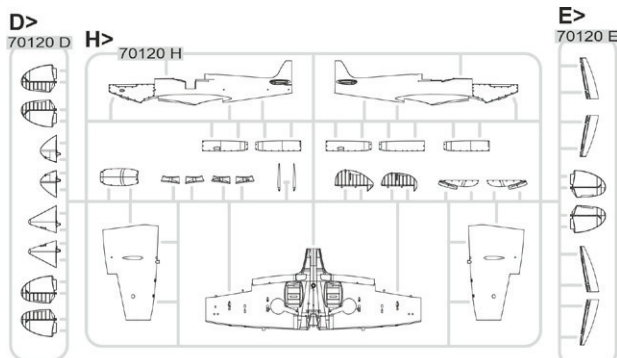
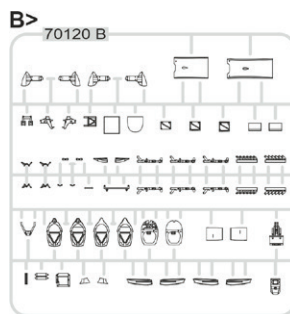
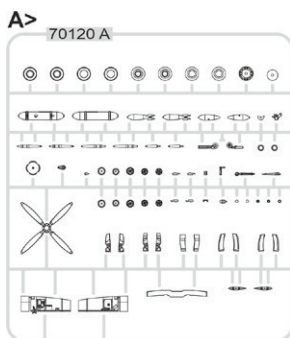

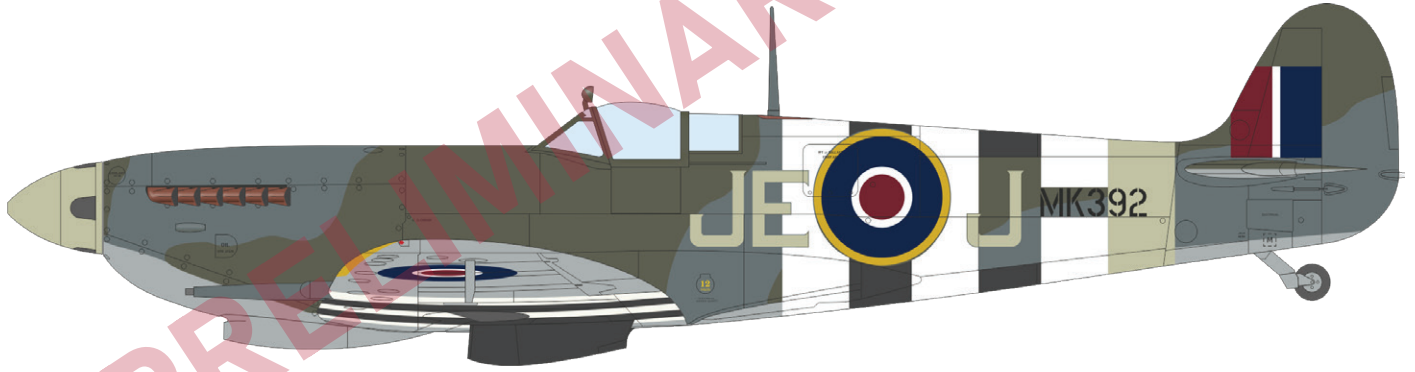
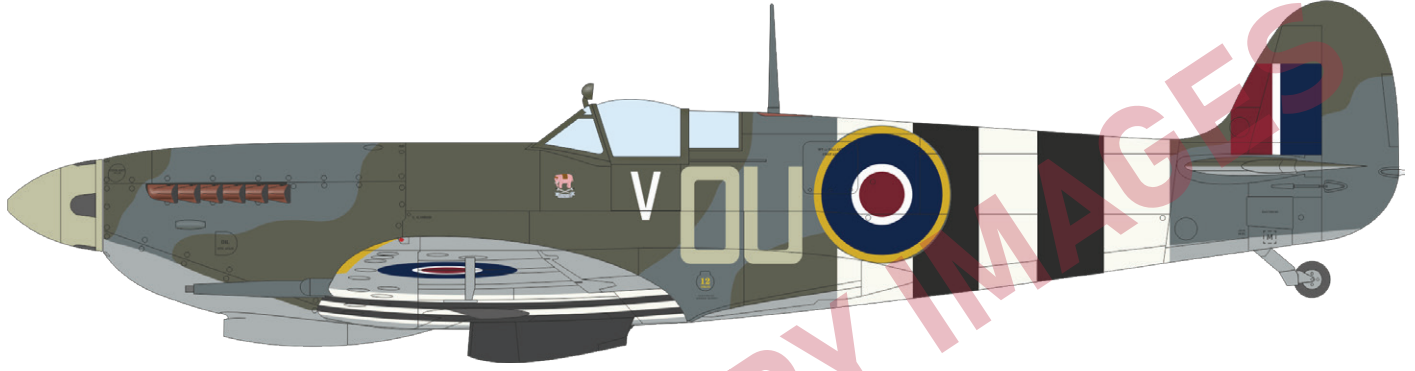

PRELIMINARY IMAGES

36518 Sd.Kfz. 251/18 Ausf. A
1/35 ICM

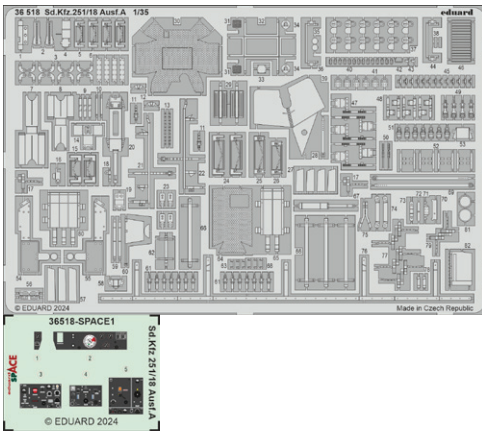

481137 FM-1 landing flaps
1/48 Tamiya

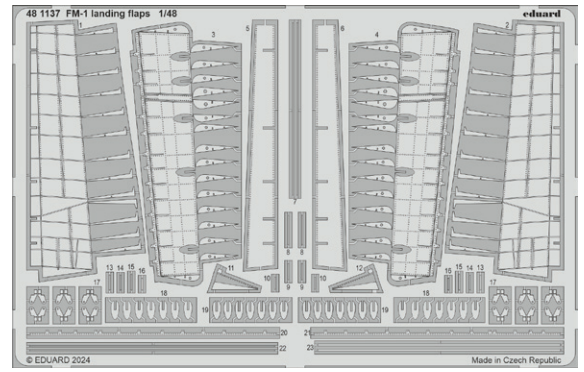

481138 MC.200 landing flaps
1/48 Italeri

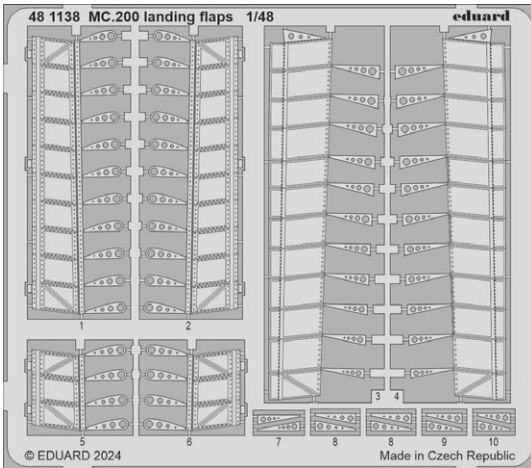

491440 Buccaneer S.2B
1/48 Airfix

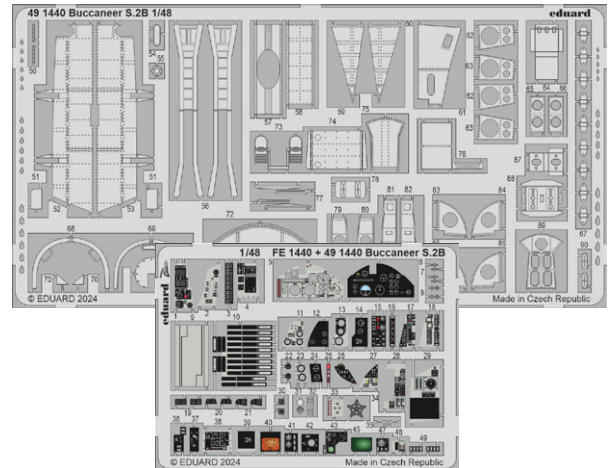

491441 Buccaneer S.2B Gulf War
1/48 Airfix

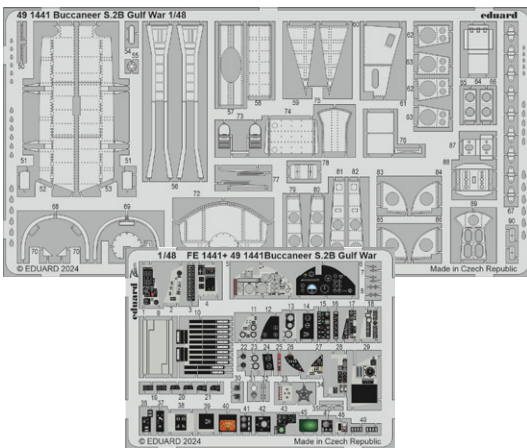

491443 FM-1
1/48 Tamiya

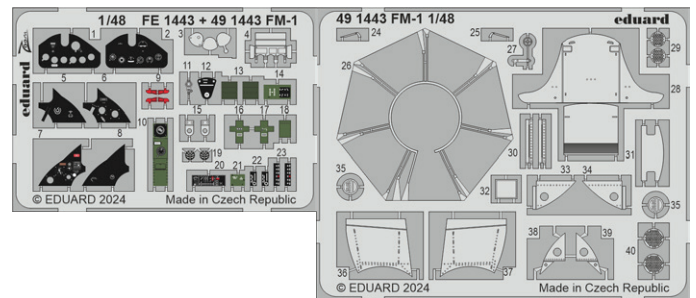

491445 F-14A
1/48 Great Wall Hobby

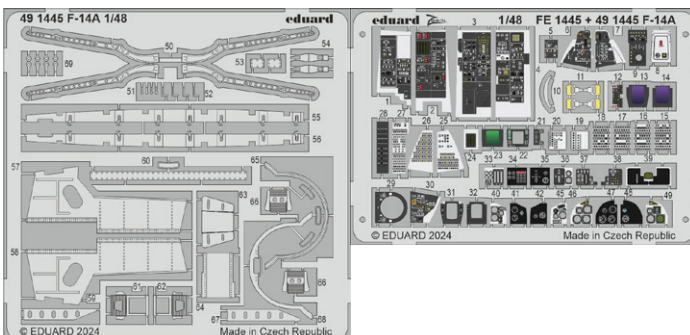

491447 MC.200
1/48 Italeri

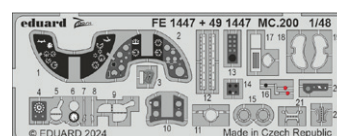
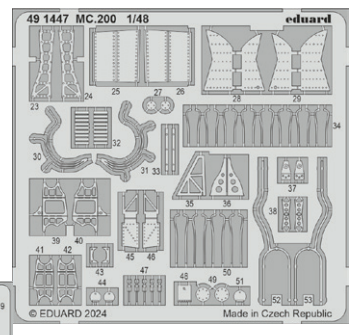

73823 CR.32
1/72 Italeri

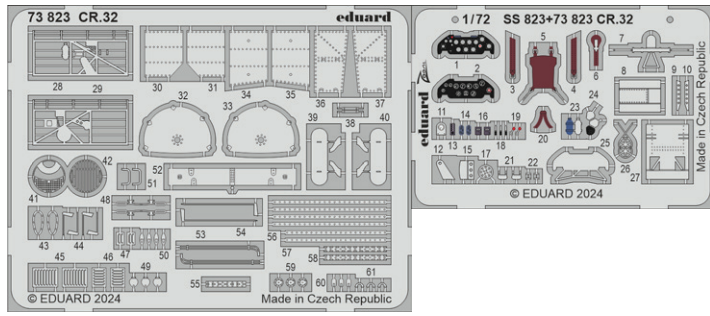

FE1140 Buccaneer S.2B
1/48 Airfix

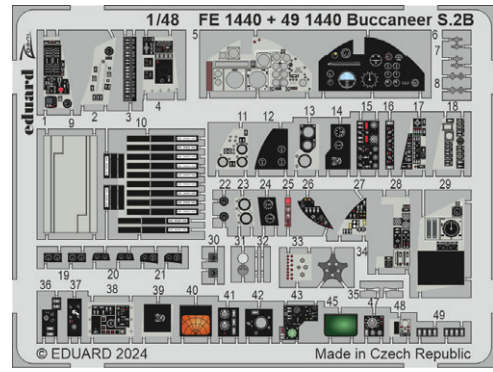

FE1441 Buccaneer S.2B Gulf War
1/48 Airfix

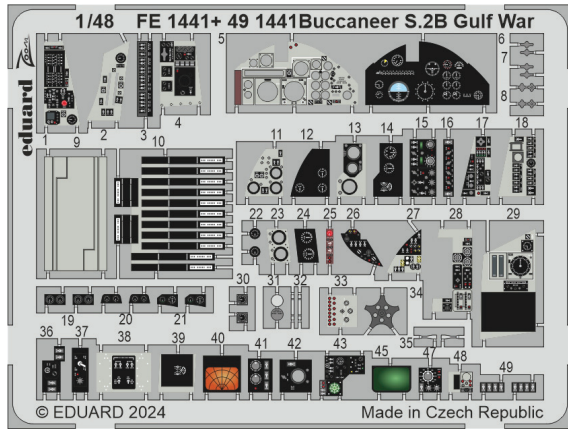

FE1442 Buccaneer S.2B seatbelts STEEL
1/48 Airfix

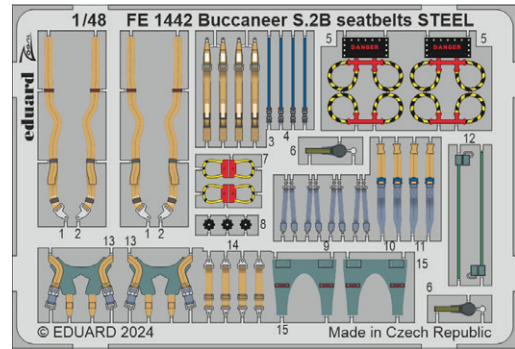

FE1443 FM-1
1/48 Tamiya

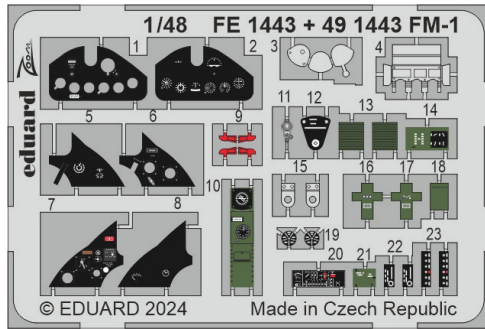

FE1444 FM-1 seatbelts STEEL
1/48 Tamiya

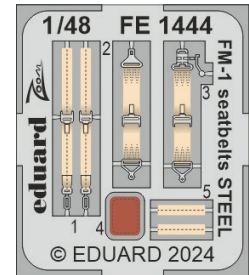

FE1445 F-14A
1/48 Great Wall Hobby

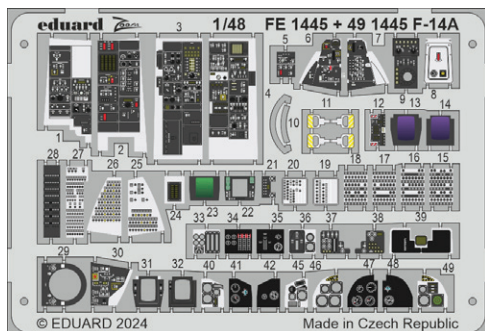

FE1446 F-14A seatbelts STEEL
1/48 Great Wall Hobby

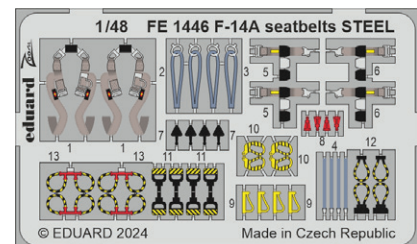

FE1447 MC.200
1/48 Italeri

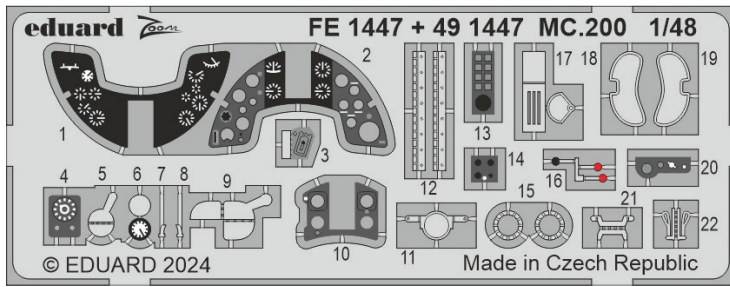

FE1448 MC.200 seatbelts STEEL
1/48 Italeri

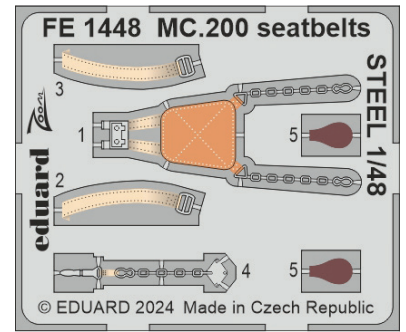

FE1449 P-51B/C seatbelts STEEL
1/48 Eduard

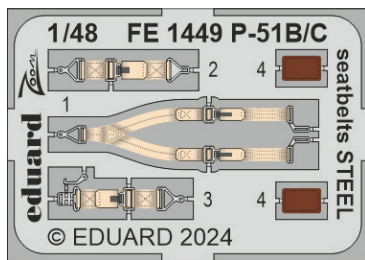

SS823 CR.32
1/72 Italeri

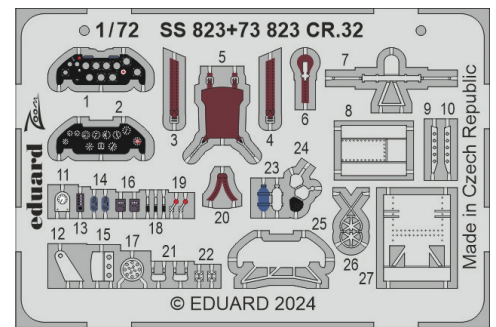

3DL48175 Buccaneer S.2B SPACE
1/48 Airfix

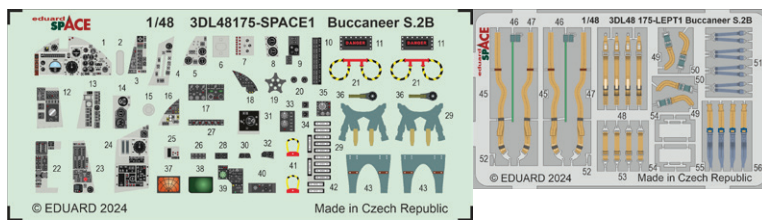

3DL48176 Buccaneer S.2B Gulf War SPACE
1/48 Airfix

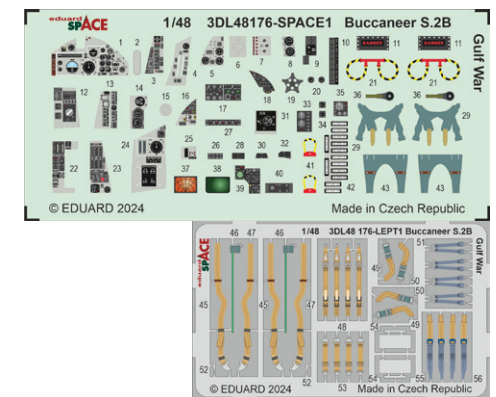

644263 Gannet AS.1/AS.4 LööK 1/48 Airfix

LööK set - Brassin pre-painted dashboard and STEEL seatbelts for Gannet AS.1 and AS.4 in 1/48 scale. Easy to assemble, replaces plastic parts. Recommended kit: Airfix

Set contains:

- resin: 1 part
- decals: no
- photo-etched details: yes, pre-painted
- painting mask: no

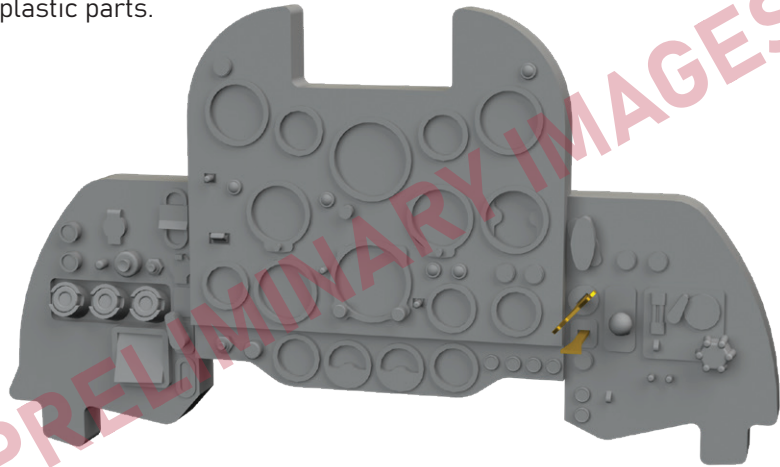

644266 Bf 108 LööK 1/48 Eduard

LööK set - Brassin pre-painted dashboard and STEEL seatbelts for Bf 108 in 1/48 scale. Easy to assemble, replaces plastic parts. Recommended kit: Eduard

Set contains:

- resin: 1 part
- decals: no
- photo-etched details: yes, pre-painted
- painting mask: no

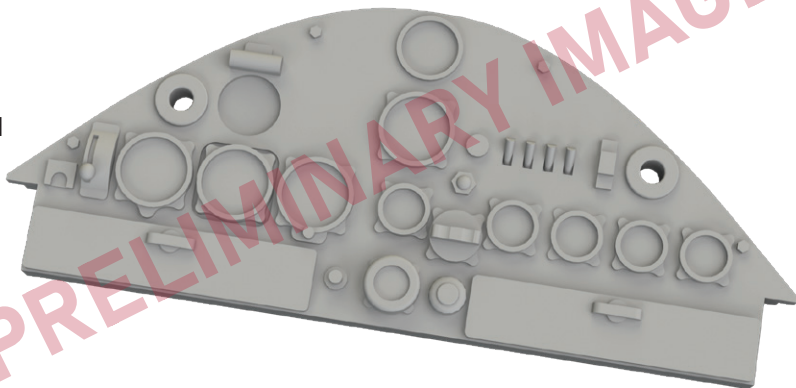

644268 P-51B/C LööK 1/48 Eduard

LööK set - Brassin pre-painted dashboard and STEEL seatbelts for P-51B and P-51C in 1/48 scale. Easy to assemble, replaces plastic parts. Recommended kit: Eduard

Set contains:

- resin: 3 parts
- decals: no
- photo-etched details: yes, pre-painted
- painting mask: no

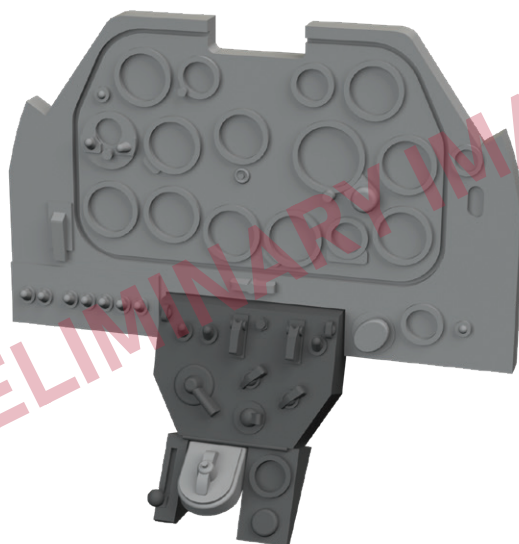

674006 Bf 109G-6 LööK 1/72 Eduard

LööK set - Brassin pre-painted dashboard and STEEL seatbelts for Bf 109G-6 in 1/72 scale.
Easy to assemble, replaces plastic parts.
Recommended kit: Eduard

Set contains:

- resin: 1 part
- decals: no
- photo-etched details: yes, pre-painted
- painting mask: no

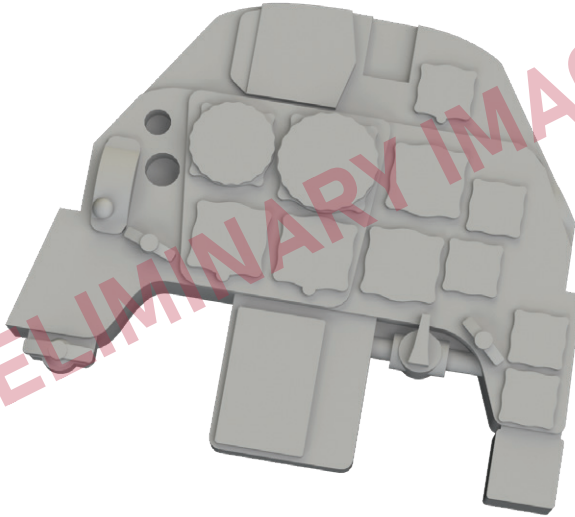

674007 Bf 109F LööK 1/72 Eduard

LööK set - Brassin pre-painted dashboard and STEEL seatbelts for Bf 109F in 1/72 scale.
Easy to assemble, replaces plastic parts.
Recommended kit: Eduard

Set contains:

- resin: 1 part
- decals: no
- photo-etched details: yes, pre-painted
- painting mask: no

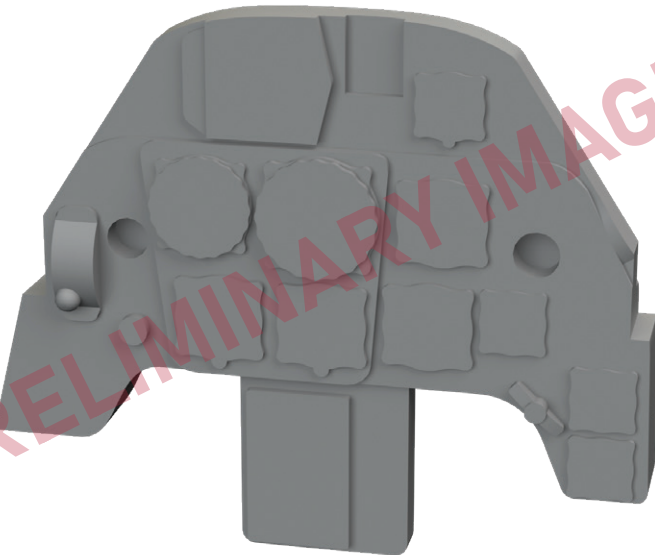

648972 F-16C Block 52 till 1996 cockpit PRINT 1/48 Kinetic

Brassin set - a cockpit for F-16C Block 52 (pre-1996 production) in 1/48 scale.
Made by direct 3D printing.
Recommended kit: Kinetic

Set contains:

- 3D print: 14 parts
- resin: 1 part, pre-painted
- decals: yes
- photo-etched details: yes, pre-painted
- painting mask: no

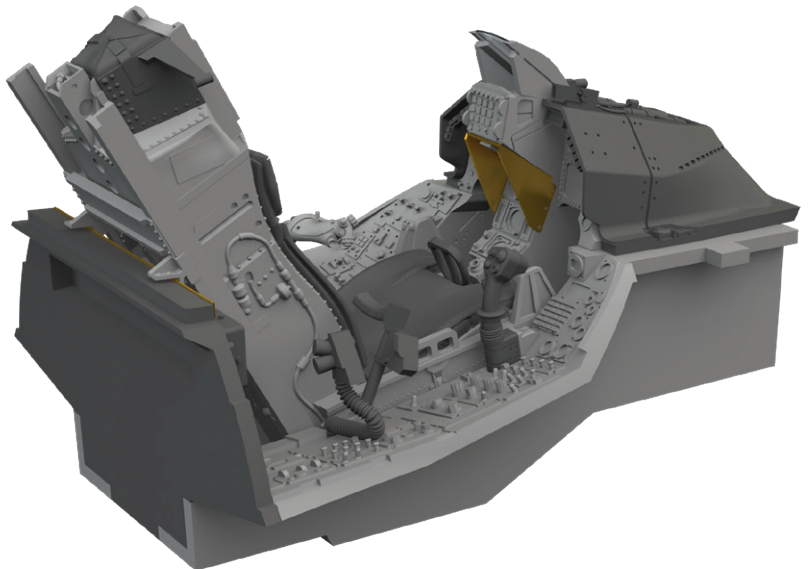
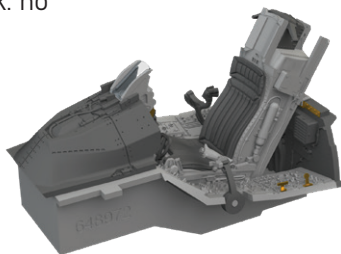

648973 F-16C Block 52 from 1997 cockpit PRINT 1/48 Kinetic

Brassin set - a cockpit for F-16C Block 52 (1997 onwards production) in 1/48 scale. Made by direct 3D printing. Recommended kit: Kinetic

Set contains:

- 3D print: 14 parts
- resin: 1 part, pre-painted
- decals: yes
- photo-etched details: yes, pre-painted
- painting mask: no

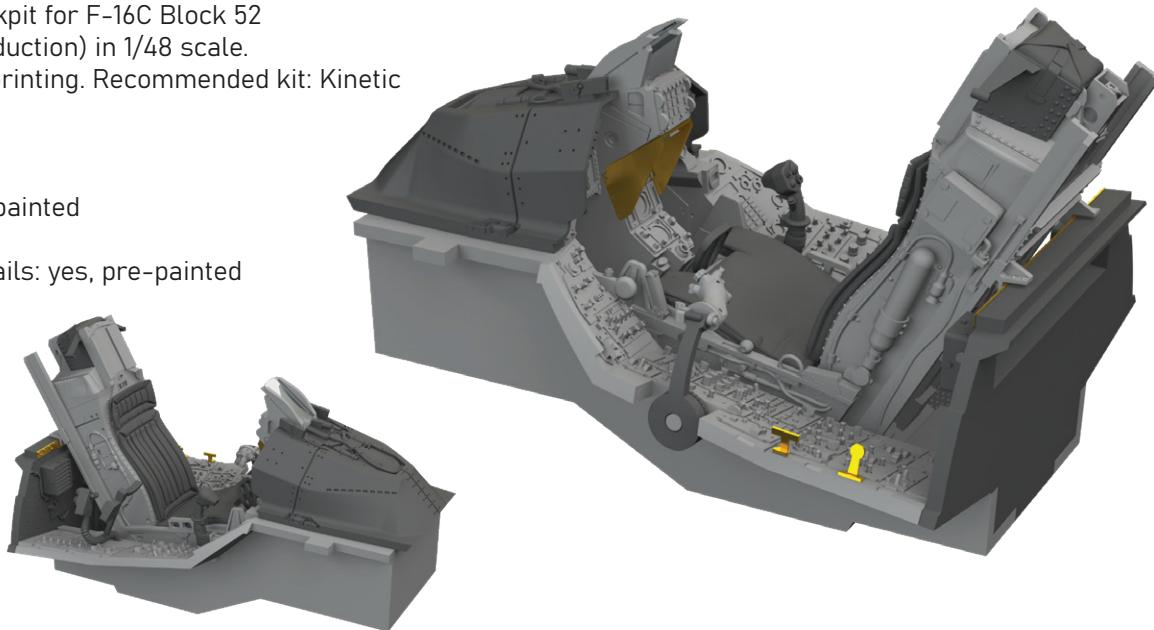

648984 F-16C wheel bays late PRINT 1/48 Kinetic

Brassin set - wheel bays for F-16C in 1/48 scale. The set consists of nose and main wheel bays. Made by direct 3D printing. Recommended kit: Kinetic

Set contains:

- 3D print: 10 parts
- decals: no
- photo-etched details: no
- painting mask: no

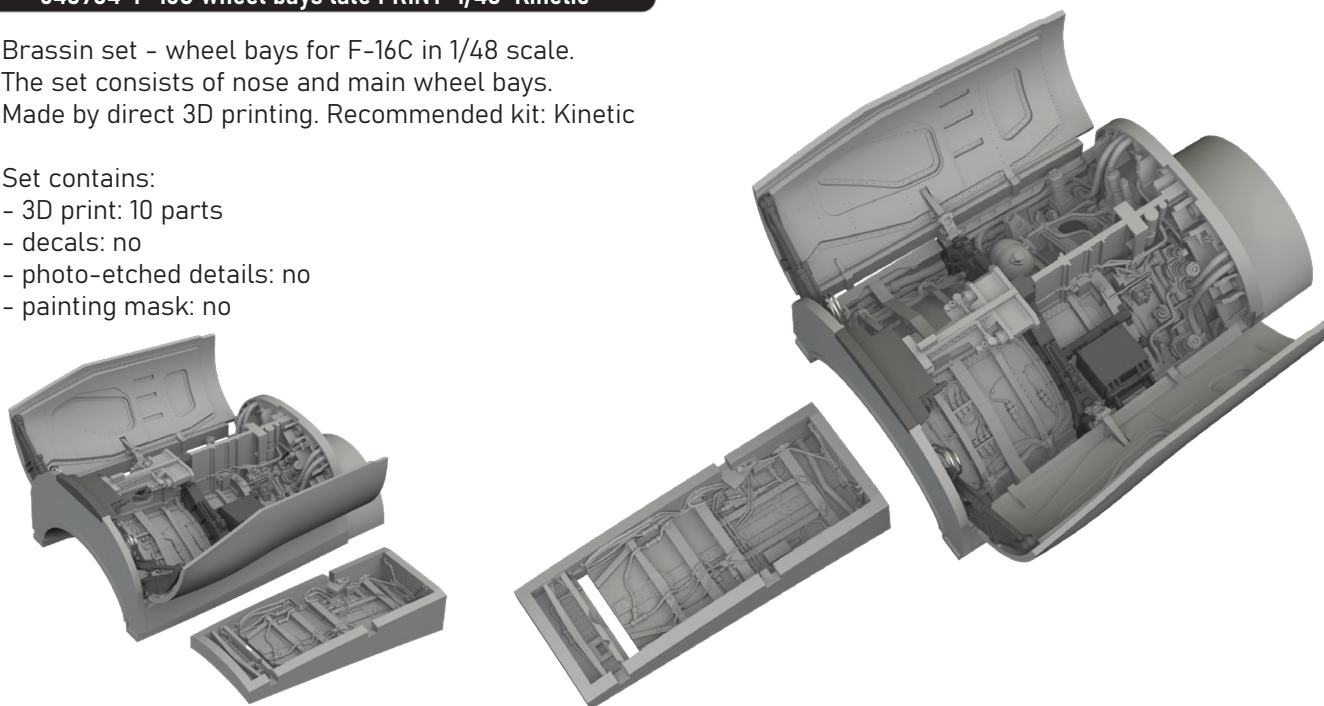

648986 P-51B/C wheels diamond tread 1/48 Eduard

Brassin set - the undercarriage wheels for P-51B or P-51C in 1/48 scale. The set consists of the main wheels and a tail wheel. Easy to assemble, replaces plastic parts. Recommended kit: Eduard

Set contains:

- resin: 3 parts
- 3D print: 2 parts
- decals: no
- photo-etched details: no
- painting mask: yes



648987 P-51B/C wheels oval tread 1/48 Eduard

Brassin set - the undercarriage wheels for P-51B or P-51C in 1/48 scale. The set consists of the main wheels and a tail wheel.

Easy to assemble, replaces plastic parts.
Recommended kit: Eduard

Set contains:

- resin: 3 parts
- 3D print: 2 parts
- decals: no
- photo-etched details: no
- painting mask: yes



648988 P-51B/C wheels cross tread 1/48 Eduard

Brassin set - the undercarriage wheels for P-51B or P-51C in 1/48 scale. The set consists of the main wheels and a tail wheel.

Easy to assemble, replaces plastic parts.
Recommended kit: Eduard

Set contains:

- resin: 3 parts
- 3D print: 2 parts
- decals: no
- photo-etched details: no
- painting mask: yes



648992 P-51B/C exhaust stacks 1/48 Eduard

Brassin set - exhaust stacks for P-51B or P-51C in 1/48 scale. Made by direct 3D printing. Easy to assemble, replaces plastic parts. Recommended kit: Eduard

Set contains:

- 3D print: 2 parts
- decals: no
- photo-etched details: no
- painting mask: no

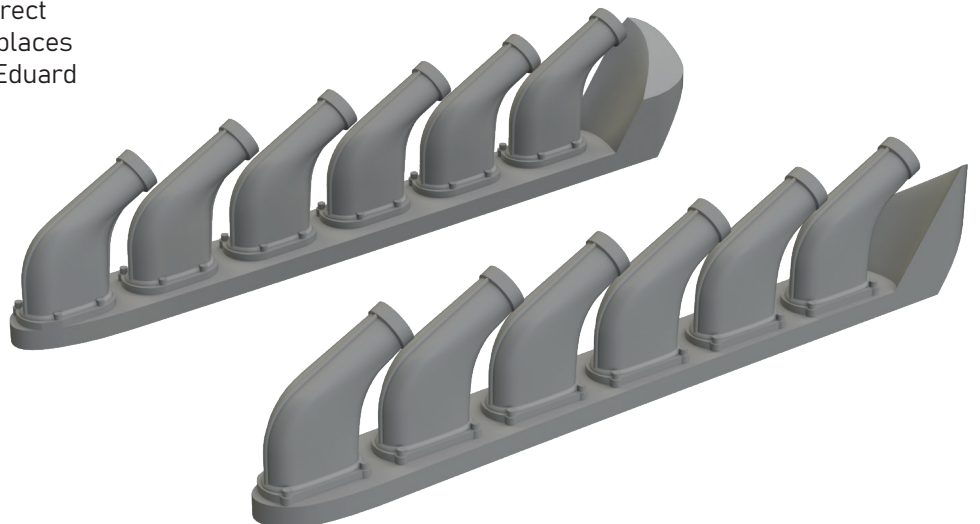

648993 P-51B/C exhaust stacks w/fairing 1/48 Eduard

Brassin set - exhaust stacks for P-51B or P-51C in 1/48 scale. Made by direct 3D printing. Easy to assemble, replaces plastic parts. Recommended kit: Eduard

Set contains:

- 3D print: 2 parts
- decals: no
- photo-etched details: no
- painting mask: no

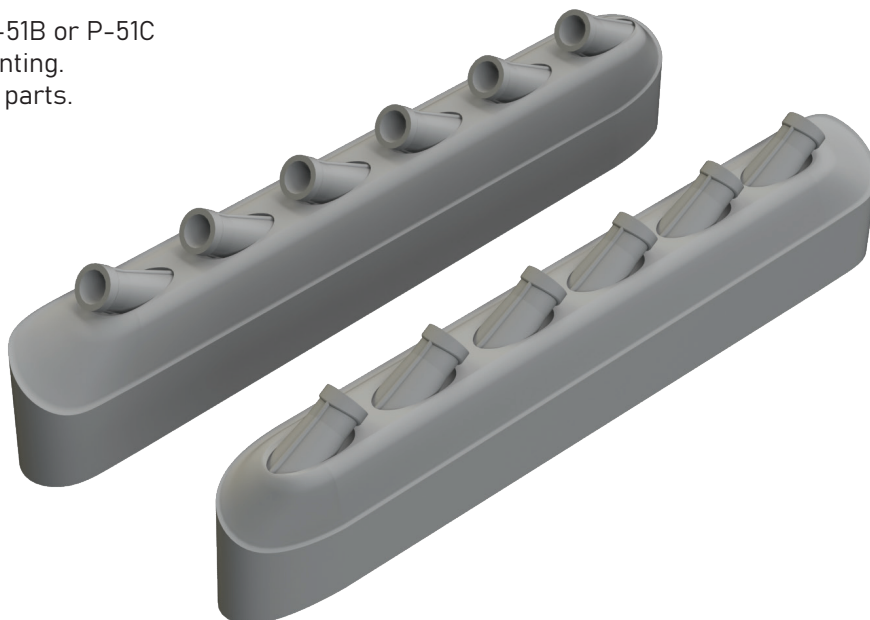

648994 P-51B/C undercarriage legs BRONZE 1/48 Eduard

Brassin set - the undercarriage legs for P-51B or P-51C in 1/48 scale. The legs are made of bronze. Recommended kit: Eduard

Set contains:

- resin: 4 parts
- bronze: 2 parts
- decals: no
- photo-etched details: no
- painting mask: no

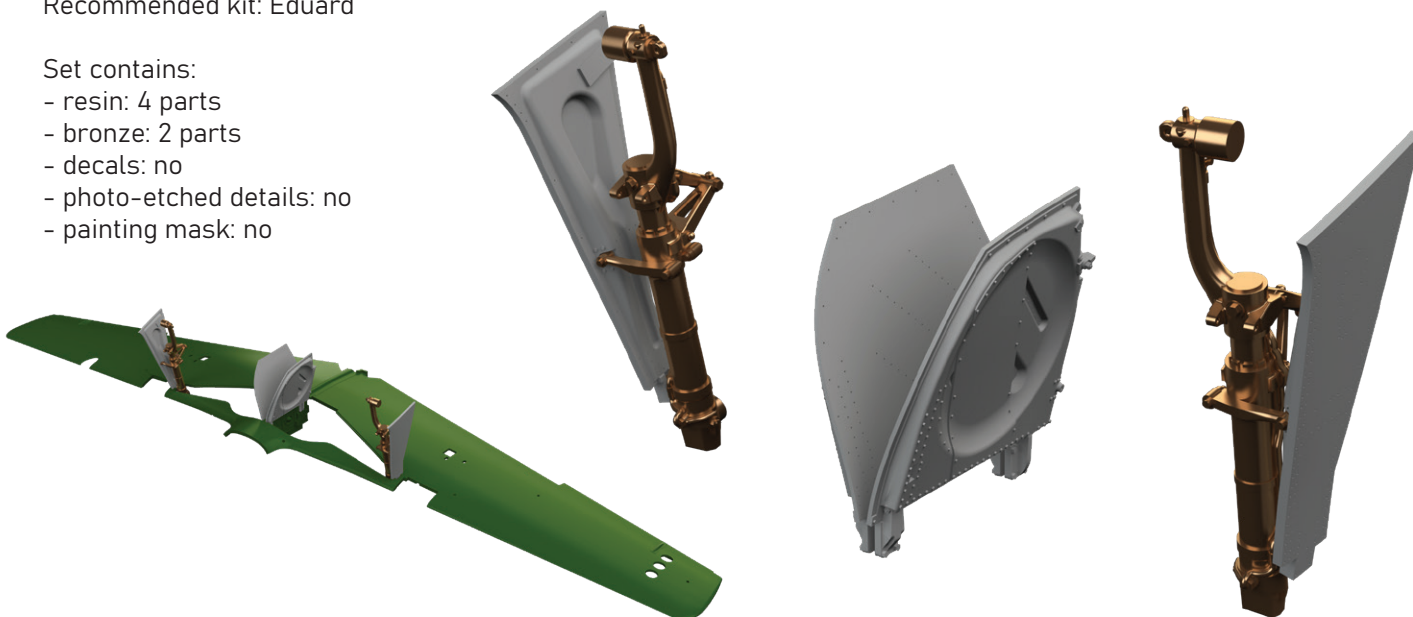

648995 F-35B lift fan PRINT 1/48 Tamiya

Brassin set - lift fan for F-35B in 1/48 scale. Made by direct 3D printing. Easy to assemble, replaces plastic parts. Recommended kit: Tamiya

Set contains:

- 3D print: 2 parts
- decals: yes
- photo-etched details: no
- painting mask: no

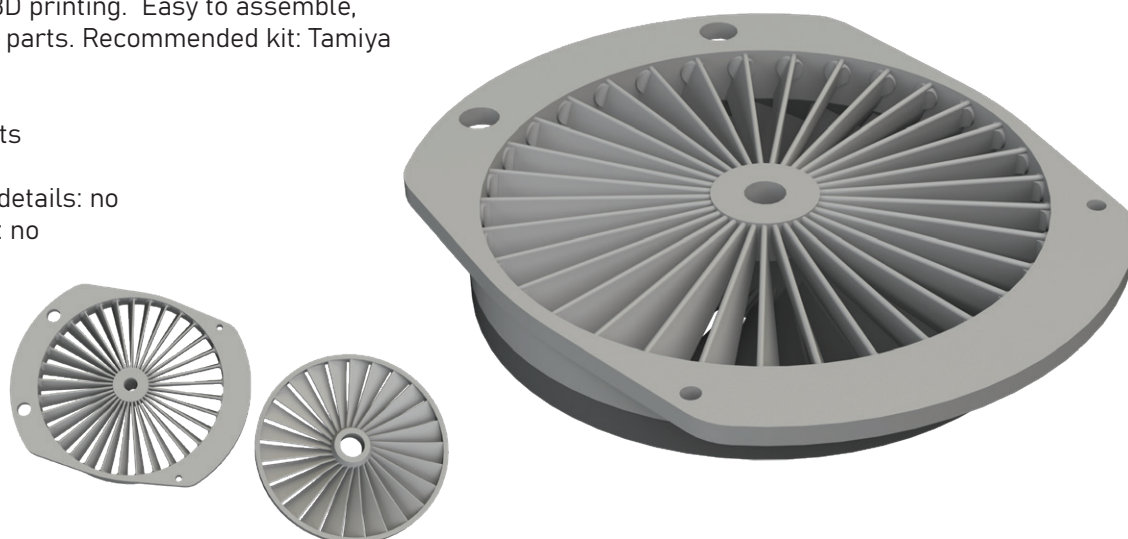

648996 Gannet wheels 1/48 Airfix

Brassin set - the undercarriage wheels for Gannet in 1/48 scale. The set consists of the main wheels and a nose wheels. Easy to assemble, replaces plastic parts. Made by direct 3D printing. Recommended kit: Airfix

Set contains:

- 3D print: 4 parts
- decals: no
- photo-etched details: no
- painting mask: yes



648997 P-51B/C gun bays PRINT 1/48 Eduard

Brassin set - gun bays for P-51B or P-51C in 1/48 scale. The set consists of gun bays for both wings. Made by direct 3D printing. Recommended kit: Eduard

Set contains:

- 3D print: 20 parts
- decals: no
- photo-etched details: yes
- painting mask: no

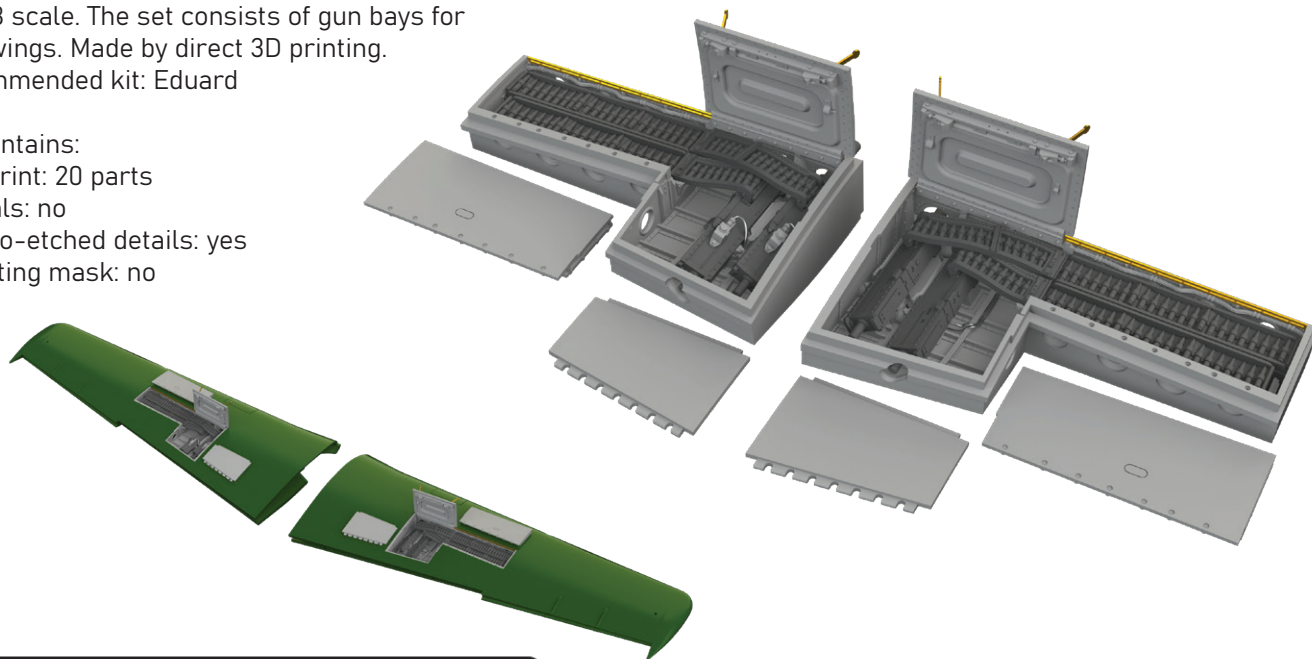

6481002 P-51B/C seat Type 1 PRINT 1/48 Eduard

Brassin set - pilot seats for P-51B or P-51C in 1/48 scale. Made by direct 3D printing. Easy to assemble, replaces plastic parts. Recommended kit: Eduard

Set contains:

- 3D print: 1 part
- decals: no
- photo-etched details: yes, pre-painted
- painting mask: no

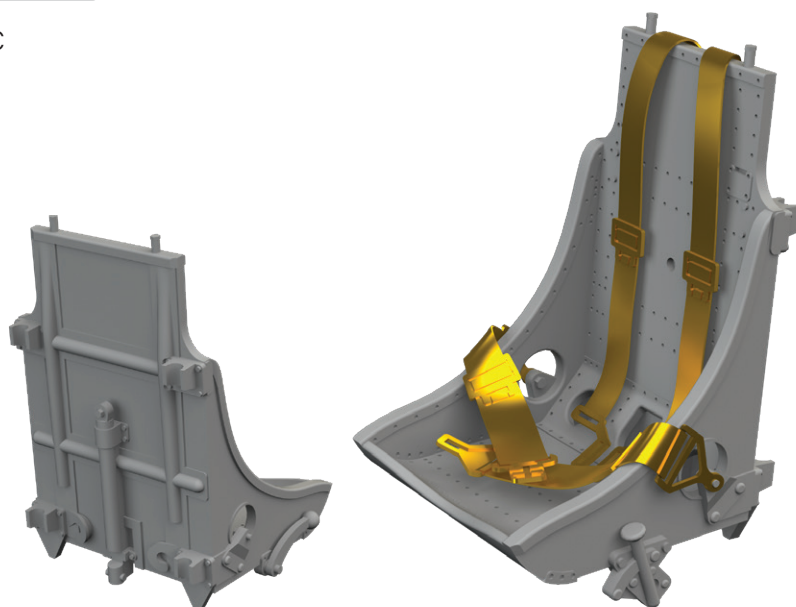

672357 L-39 ejection seats PRINT 1/72 Eduard

Brassin set - ejection seat for L-39 in 1/72 scale.
Made by direct 3D printing. Easy to assemble,
replaces plastic parts. Recommended kit: Eduard

Set contains:

- 3D print: 2 parts
- decals: yes
- photo-etched details: yes, pre-painted
- painting mask: no

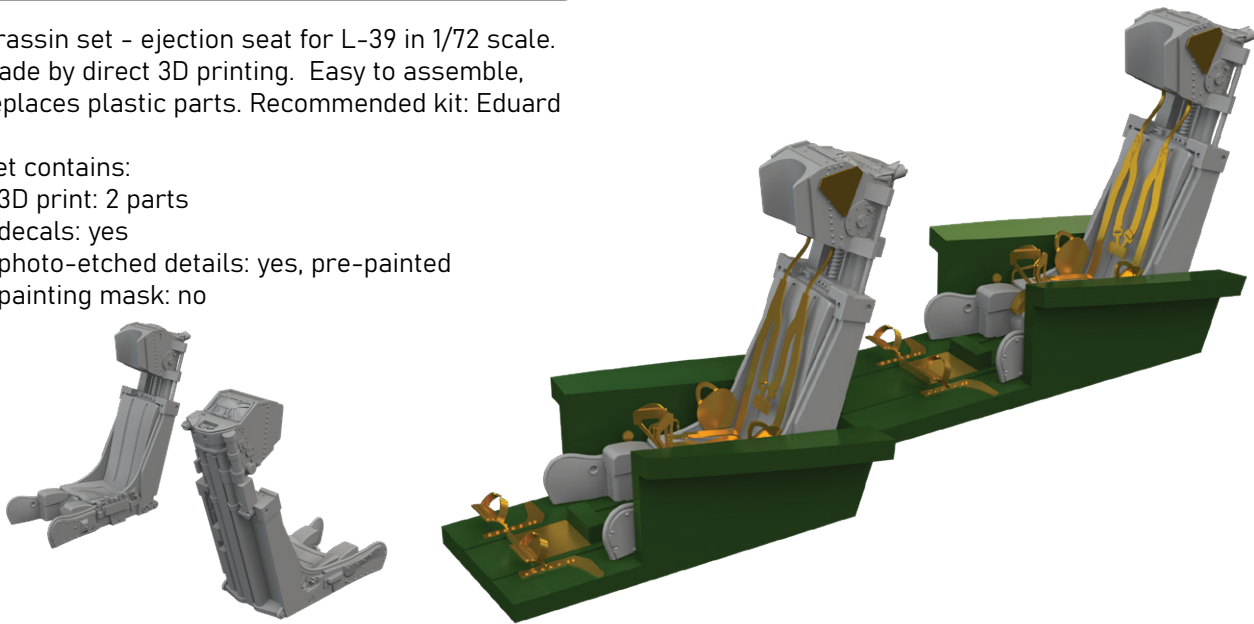

644243 Fw 190A-7 LööKplus 1/48 Eduard

Collection of 3 sets for Fw 190A-7 in 1/48 scale.
Recommended kit: Eduard

- LööK set (pre-painted Brassin dashboard & Steelbelts)
- TFace painting mask
- undercarriage wheels

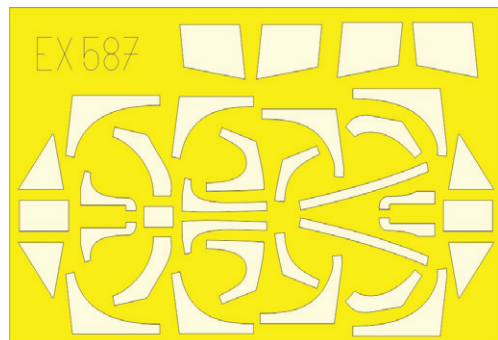
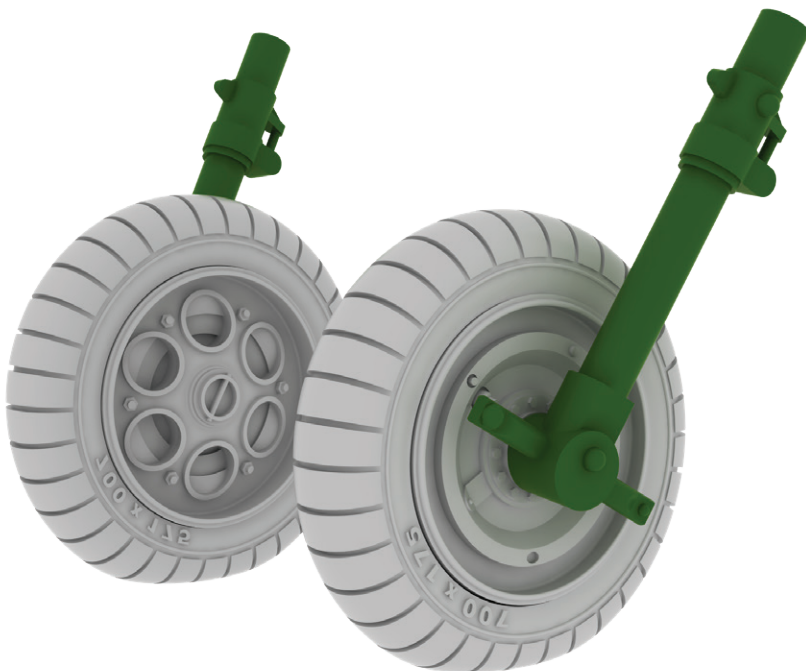
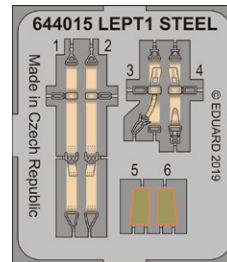

644267 F-35B LööKplus 1/48 Tamiya

Collection of 4 sets for F-35B in 1/48 scale.
Recommended kit: Tamiya

- LööK set (pre-painted Brassin dashboard & Steelbelts
- TFace painting mask
- undercarriage wheels
- ejection seat

LööKt

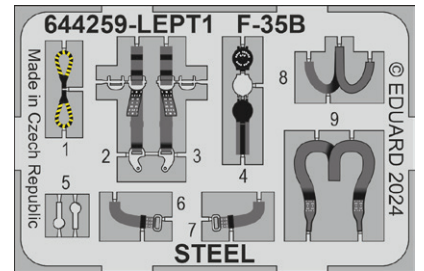
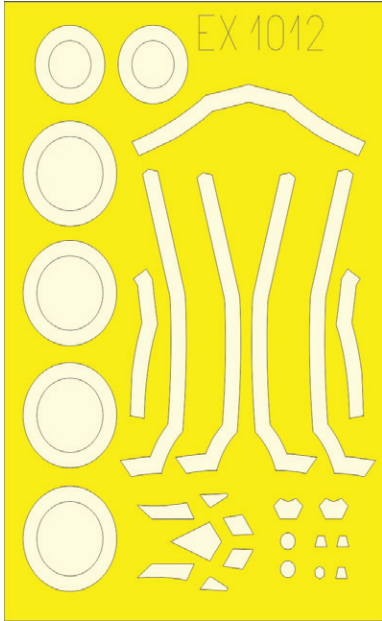



Collection of 5 sets for Su-25 in 1/48 scale. Recommended kit: Zvezda

- ejection seat
- wheels
- gun muzzle
- slats & landing flaps
- air brakes (early type)

All sets included in this BIG SIN are available separately, but with every BIG SIN set you save up to 30 %.

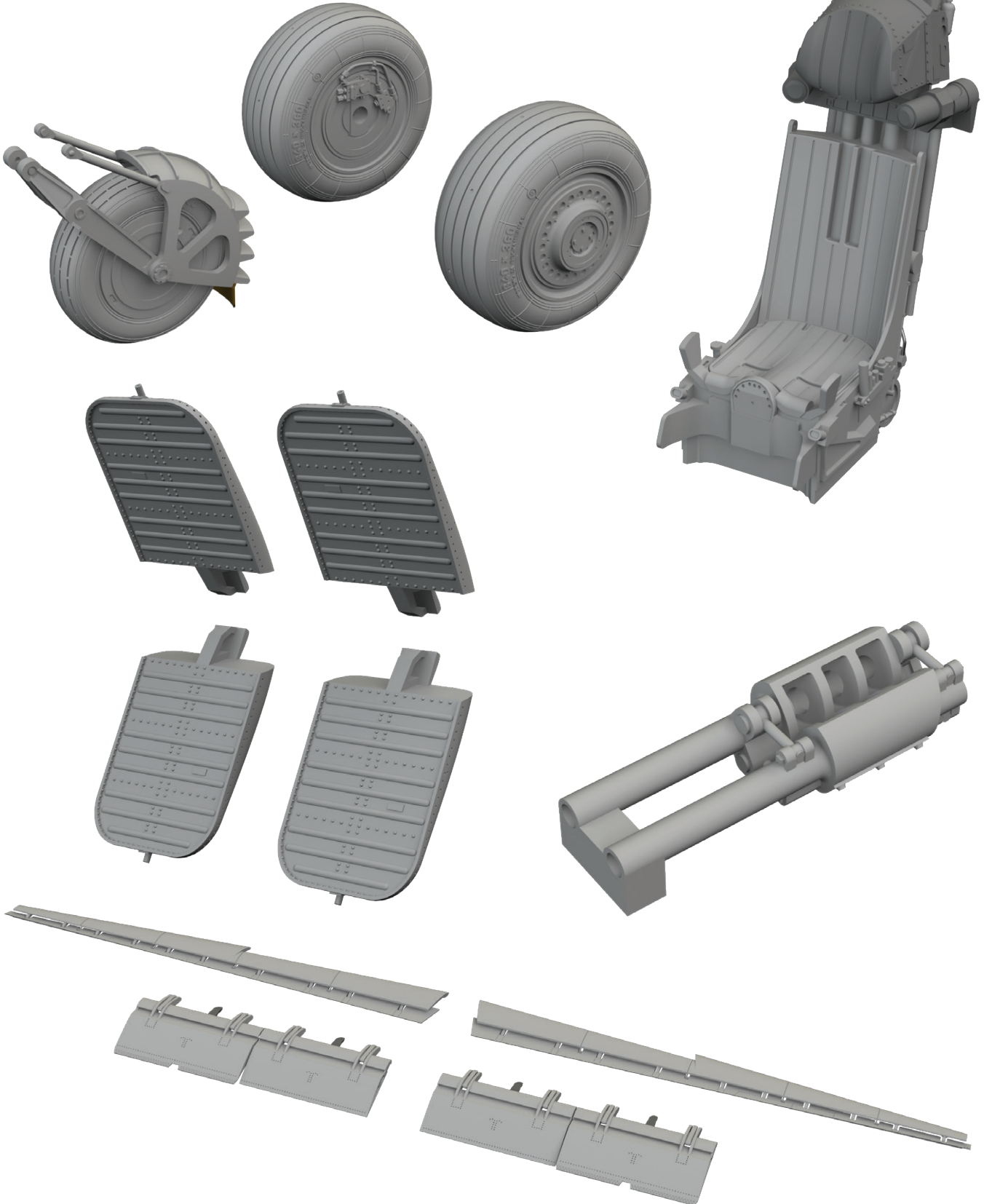

SIN67223 Bf 109G-6 1/72 Eduard

Collection of 6 sets for Bf 109G-6 in 1/72 scale.
Recommended kit: Eduard

- cockpit
- engine,
- undercarrigae legs BRONZE
- propeller
- undercarriage wheels
- radio compartment



All sets included in this BIG SIN are available separately,
but with every BIG SIN set you save up to 30 %.

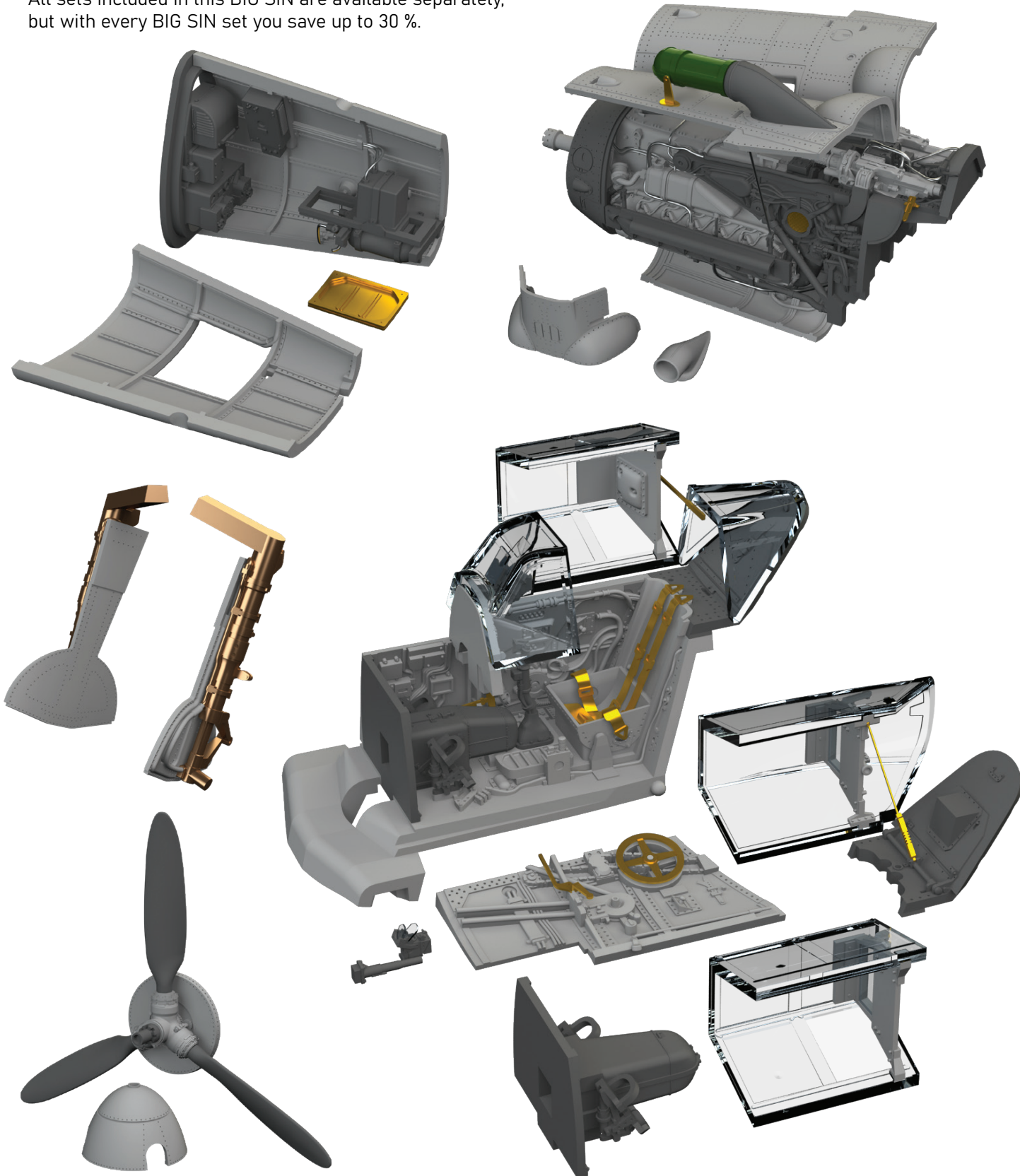

BIG5371 USS Iowa BB-61 1/350 Hobby Boss

- 53302 USS Iowa BB-61 part 1 1/350
- 53303 USS Iowa BB-61 part 2 1/350
- 53304 USS Iowa BB-61 part 3 1/350

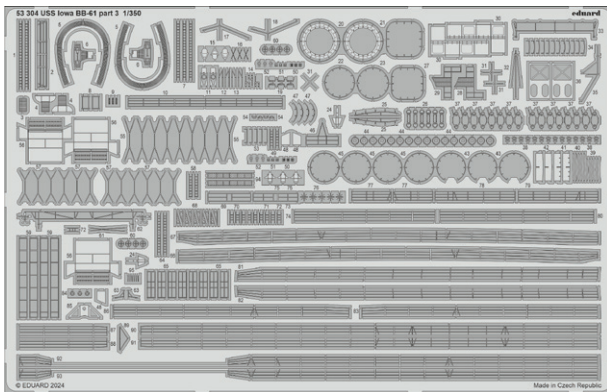
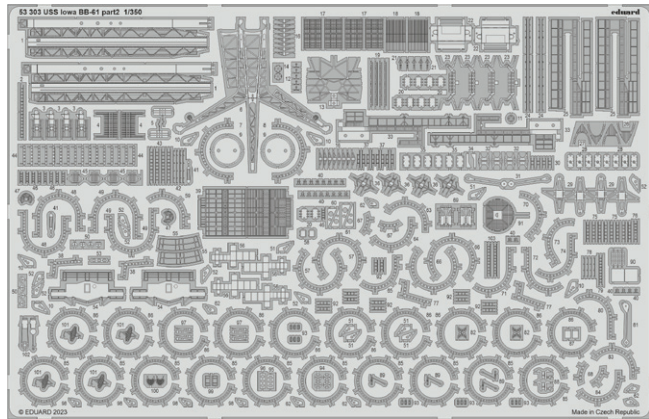
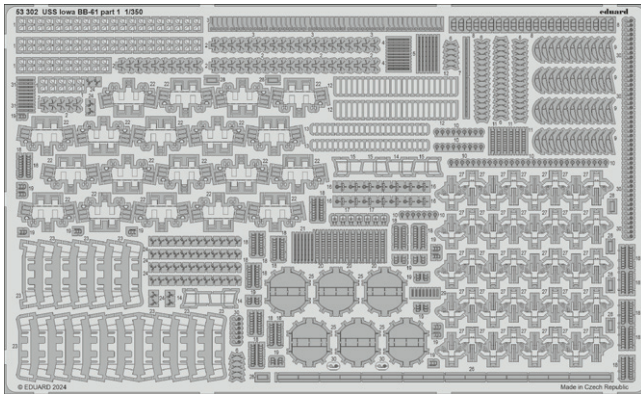

BIG49403 Ki-21-I 1/48 ICM

- 49144 Ki-21-I 1/48
- FE1415 Ki-21-I seatbelts STEEL 1/48
- EX1004 Ki-21-I 1/48

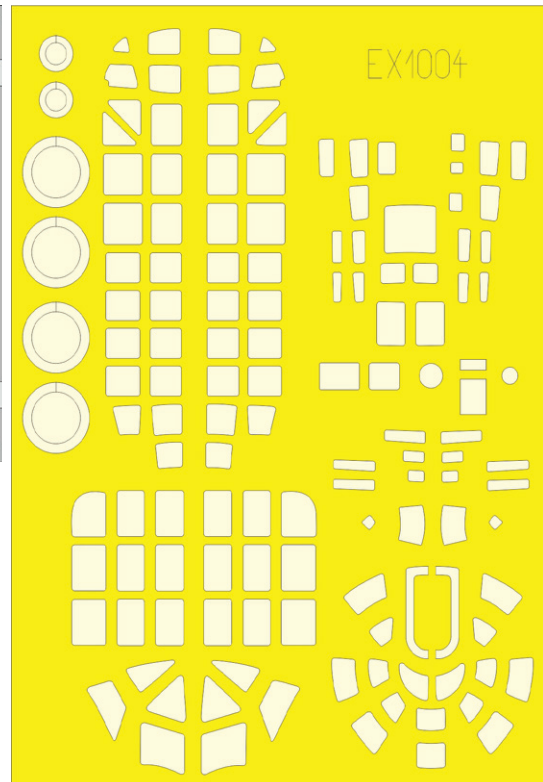
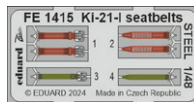
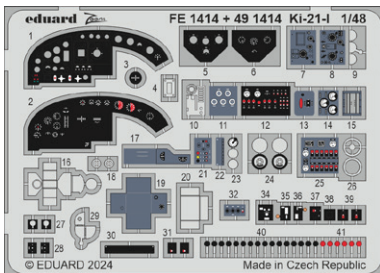
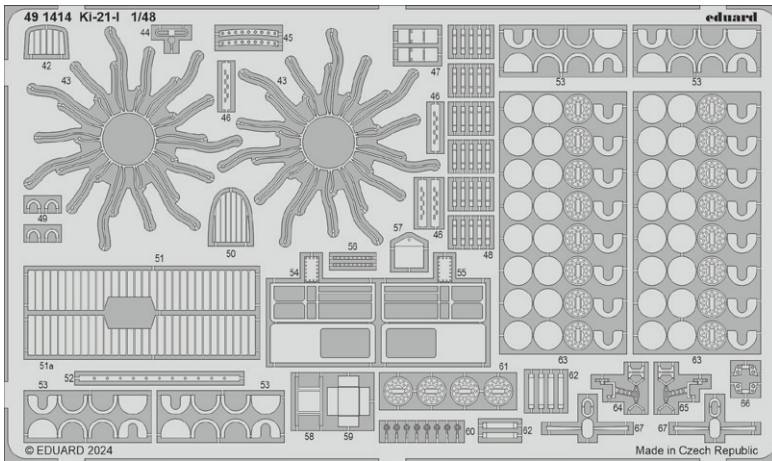

BIG49404 Go 244B 1/48 ICM

- 491417 Go 244B 1/48
- FE1418 Go 244B seatbelts STEEL 1/48
- EX1006 Go 244B 1/48

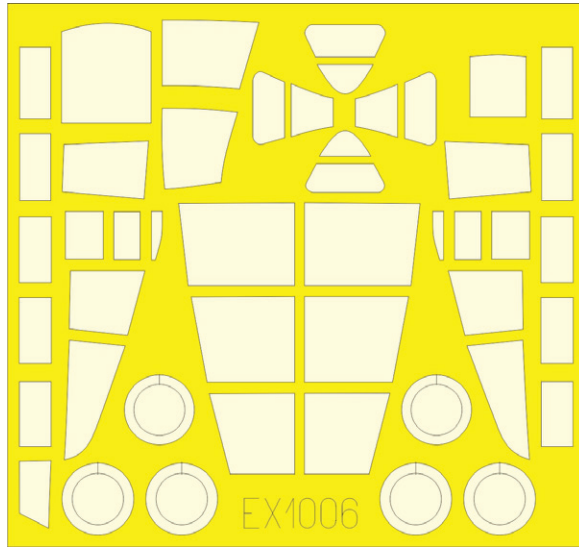
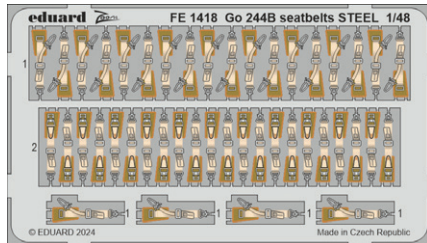
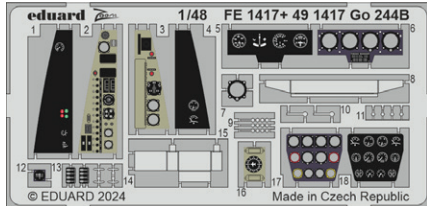
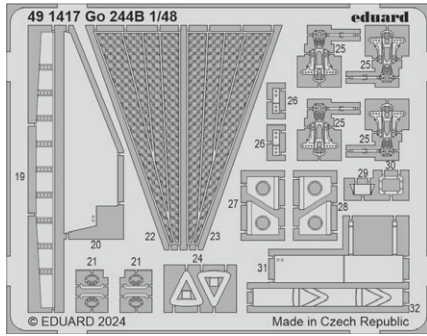

BIG49405 SM.79 1/48 Eduard

- 481129 SM.79 bomb bay 1/48
- 481130 SM.79 undercarriage 1/48
- 481131 SM.79 rear fuselage interior 1/48
- FE1416 SM.79 seatbelts STEEL 1/48

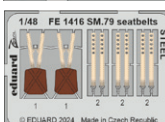
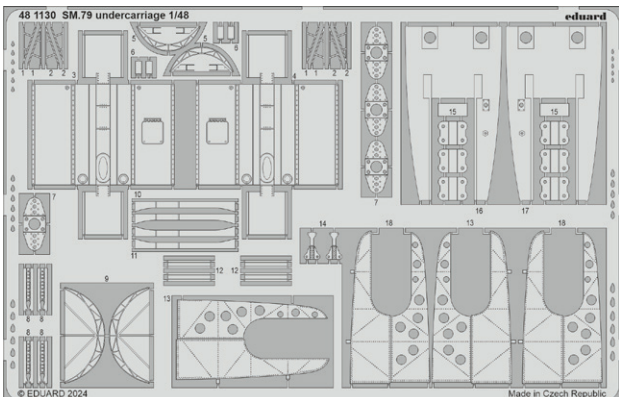
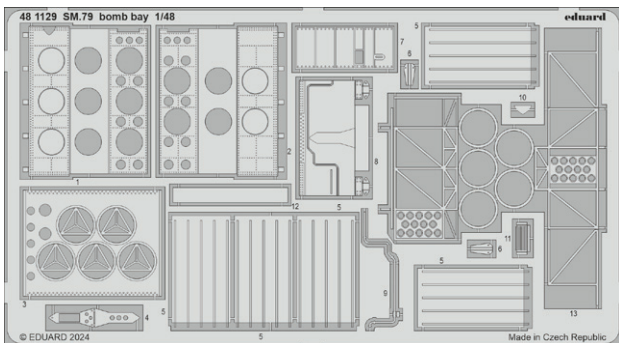
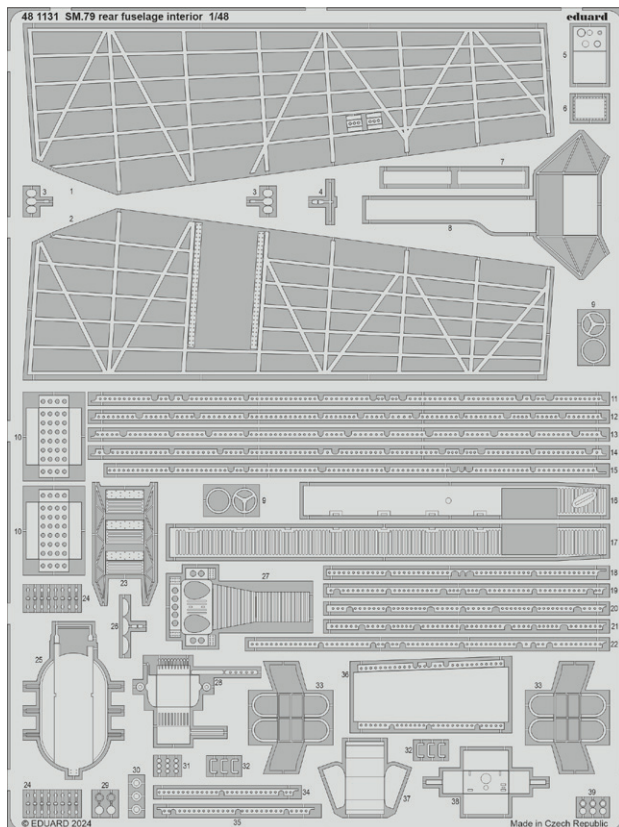

Bf 109G-6

1/72 Eduard

AVAILABLE ACCESSORIES:

- 672292 Luftwaffe rudder pedals PRINT (Brassin)
- 672324 Bf 109 SC250 bomb (Brassin)
- 672329 Bf 109 balance weights PRINT (Brassin)
- 672338 Bf 109G undercarriage legs BRONZE (Brassin)
- 672344 Bf 109G radio compartment PRINT (Brassin)
- 672346 Bf 109G propeller PRINT (Brassin)
- 672347 Bf 109G-5/G-6 cockpit PRINT (Brassin)
- 672348 Bf 109G-5/G-6 wheels PRINT (Brassin)
- 672352 Bf 109G-6 engine PRINT (Brassin)
- 672355 Bf 109G-5/G-6 gun barrels PRINT (Brassin)



#672324

#672344

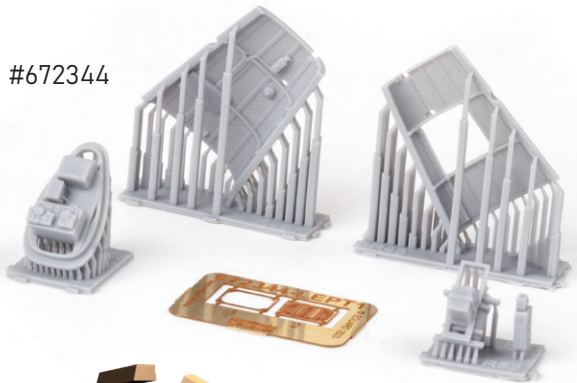

#672347

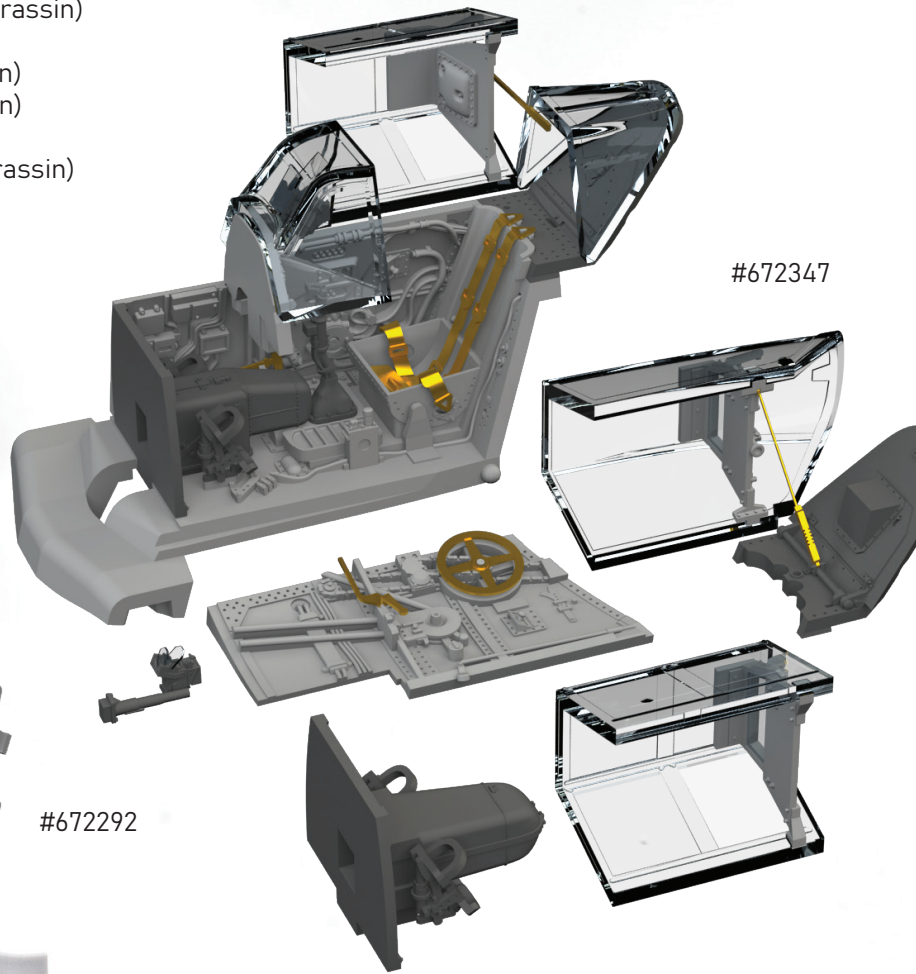

#672338



#672292



#672352





GUSTAV Pt.2

The famous WWII German fighter Bf 109G-6 and G-14 in the service with German, Finnish, Italian and Hungarian units all over Europe

#2145

- ✦ The premiere of the new Eduard design and tooling
- ✦ Photo-etched and pre-painted parts for the finest detail
- ✦ Die cut masks for easy painting
- ✦ Decals for 10 marking options

APRIL RELEASE

Option to purchase a separate set of Overtrees plastic parts., #70160X

www.eduard.com

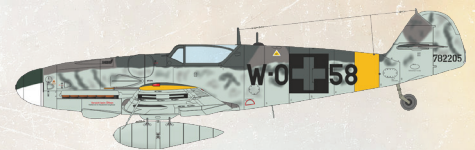

Bf 109G-14, WNr. 782205, Lt. Antal Szebeni, 101/5. Vadászszázad MKHL, Börgönd, Hungary, October 1944



Bf 109G-6/R6, WNr. 160303, Hptm. Friedrich Eberle, CO of III./JG 1, Volkel, the Netherlands, November 1943 - January 1944

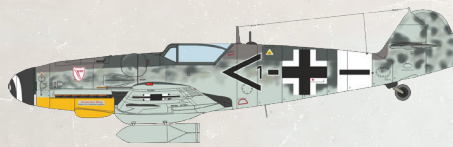

Bf 109G-6/R1, Lt. Max-Bruno Fischer, Stab II./JG 3, Evreux-Fauville, France, June 1944

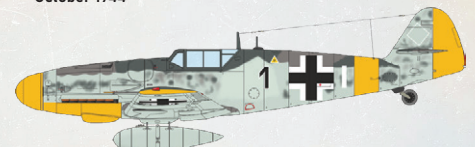

Bf 109G-6, Lt. Anton Hafner, CO of 10./JG 51, Tilsit-East, the Soviet Union, August 1944



Bf 109G-14, Hptm. Erich Hartmann, CO of I./JG 53, Veszprém, Hungary, February 1945



Bf 109G-6, WNr. 165267, Majuri Eino Luukkanen, 1/HleLv 34, Taipalsaari airfield, Finland, July 1944



Bf 109G-14, Oblt. Rolf Schlegel, 10./JG 4, Jüterbog-Damm, Germany, March 1945



Bf 109G-14, WNr. 465437, Hptm. Franz Dörr, CO of III./JG 5, Gossen, Norway, May 1945



Bf 109G-14/U4, WNr. 512382, Lt. Horst Schlick, 4./JG 77, Schönwalde, Germany, November 1944



Bf 109G-14, WNr. 464380, Maggiore Mario Bellagambi, CO of 5ª Squadriglia, 2° Gruppo Caccia ANR, Osoppo, Italy, March 1945