

INFORMATION FOR DISTRIBUTORS

DECEMBER 2023

Hello, dear friends,

Allow me to briefly update you on the new developments coming up in December 2023, as well as a few current procedural matters.

THE KITS

The most interesting December new release will be the FM-1 Wildcat in 1/48th scale in the ProfiPACK line. This kit will essentially complete the range of 1/48th scale of the main Wildcat versions in our production. Unlike the other Wildcats, including FM-2, we will not be releasing FM-1 in the LIMITED series. The FM-1 was a licensed version of the Wildcat, based on the F4F-4, produced by the Eastern Aircraft Division factory, which was part of General Motors. The FM-1 were incorporated into the armory of US Navy units deployed primarily on escort carriers and they were also widely used by training units. They also served as the Martlet V in the British Royal Navy. Our plastic kit, like the real aircraft, differs from the F4F-4 version by having a wing armed with four 12.7 mm machine guns, and were capable of carrying a number of variants of armament and equipment on the underwing pods, like unguided rockets, bombs and drop tanks. The decal sheet offers six versions of the color schemes. One of them is an US aircraft from service in the Pacific, two other represent planes deployed in the Atlantic. The fourth US scheme is a plane from training unit, very brightly colored by US Navy standards which was also deployed in combat. The two remaining aircraft are Royal Navy Martlets V. One of these took part in the Normandy landing and the other in the Dragoon operation landing in southern France. The boxart will show a Wildcat from VC-1 unit in Atlantic camouflage, operating from the escort carrier USS Block Island, depicted during the mission in which the German submarine U-220 was sunk.

In December, we will also release a ProfiPACK kit of the P-39N Airacobra in 1/48th scale. The Weekend series will be extended by the Bf 109E-4 in 1/48th scale and the Avia S-199 early version with original Erla canopy in 1/72nd scale. In addition, three items are ready as reissues: the Bell X-1 and the Bf 109 G-4, both in the ProfiPACK series and in 1/48th scale. Last one is Albatros D.V Weekend edition in 1/72nd scale. In addition to these items, we will be re-launching the Bf 110G-4 kit in 1/48th scale in the ProfiPACK series, catalogue number 8208. This is a kit that was a new release planned for January 2021, but during a fire in December 2020, the moldings were lost. Some part of the production made it to market at that time and sold out very quickly. We will release the remaining 850 pieces for sale in December. This is an attractive item, the number of available kits is limited, so I strongly recommend you do not hesitate to order and in any case pre-order for this item. I suspect that without a pre-order the chances of buying this kit will be very

low. In this context I would like to remind you that **we are releasing another older item** in its original packaging now, **the MiG-21PFM in ProfiPACK edition in 1/48th scale, cat. no. 8237**. There are only 310 of these kits available, so it can be assumed that the availability situation will be similar to that of the Bf 110 G-4.

As part of the November block of new releases, Wilder Cat kit (FM-2 Wildcat), cat. no. 11175, and the Kurfürst (Bf 109 K-4) kit, cat. no. 11177, will be back in stock.

BRASSIN

Among the December Brassin sets I would like to mention first a large collection of 1/48th scale items for the FM-1 Wildcat kit. There are eight items in total, including large sets for wheel wells, engine, or folded wings.

Also of interest is the collection of 1/48th scale sets for the Fw 190A-7, the plastic model kit we are launching as part of the November line-up. In December, a cockpit set will be available, as well as an engine with fuselage machine gun installation and a set of bronze landing gear legs.

For the next November release of our plastic kits, the Wunderschöne neue Maschinen pt.2 in 1/72nd scale, the December offer will include sets for the cockpit of the Bf 109G-2 (672342) and for the cockpit of the Bf 109G-4 (672343), a set of the later (larger) landing gear wheels (672341) and a radio installation set that is applicable to all Bf 109s with the DB 605 engine from the G-4 version up to the Bf 109K-4 (672344). In addition, we offer the VDM 9-12087.10 propeller for the Bf 109G with DB 605A engines used on the Bf 109G-2/G-4, and also on the Bf 109G-6 and G-14.

For December we also have prepared a set of wheel wells for the F6F Hellcat in 1/72nd scale, which we have produced based on numerous requests from modelers. It is probably appropriate to add that it is intended for plastic kits of our own production, same applies to the auxiliary tank for the Bf 109K-4 in 1/48th scale. You will probably have noticed that the Brassin series set line-up in December is unique in that, probably for the first time in our history, most of the Brassin accessories released are intended for kits of our own production. It's not the entire production run though, one small set is also designed for another manufacturer's kit, a set of 1/48th scale gun ports for the Hurricane Mk.II by Arma Hobby.

ACCESSORY SETS – PHOTO-ETCHED PARTS, MASK AND DECALS

The situation is different in photo-etched sets, where we mainly service plastic kits produced by other companies. In December, the dominant ones will be sets for helicopter kits. There will be three 1/48th scale cargo interior sets for the new Sea King from Airfix (HAS.1, HAS.5 and HU.5), three 1/48th scale sets for the Mi-17, supplemented by two Zoom series sets,

two mask sets and a SPACE series set, and three etched sets plus two mask sets for the AH-1G 1/35 from ICM.

Another distinctive line-up of photo-etched sets will be intended for Seafire F.XVII in 1/48th scale by Airfix, for which we have prepared two classic etched sets, two sets of Zoom series, two sets of masks and a set of 3D decals SPACE. In addition to these larger sets, which will eventually become BigEd series items, we will also be offering individual sets for other scale models, such as the flaps for the FM-1 Wildcat (Eduard), and for the December releases of our Weekend series, the Bf 109 E-4 (1/48) and Avia S-199 (1/72), we will be offering Zoom series sets, masks and SPACE series sets. These are available for all Eduard plastic kits of all product lines for December. The photo-etched sets will include additional 1/350th scale naval items for the Trumpeter-produced aircraft carrier USS Nimitz. These are the sixth and seventh sets for this large plastic kit. In 1/35th AFV scale we have prepared two new sets for December: one for the Dodge WC-52 (cat. no. 36511) and the other for the BMP-3 (cat. no. 36512), both intended for Zvezda kits.

I would also like to mention two sets of decals for the F-35A kit by Tamiya. One will be available in 1/72nd scale and the other in 1/48th scale.

In addition to the abovementioned sets, BigEd, BigSin and LööK Plus sets are also traditionally offered.

SHIPPING OF NOVEMBER ITEMS

November's new releases are ready for shipping and will be dispatched from October 17. If you have not already done so, please do send in your orders for the November new releases and any restock items.

At the same time, I would like to kindly ask you to send in your pre-orders for the December new releases, preferably by Wednesday, November 1, 2023. It is advisable to meet this deadline, as we are putting the quantities of the December new releases into production based on the status of your pre-orders.

If we do not have your pre-order, we do not guarantee delivery of all items in your future order. Such situations occur especially with LIMITED series items. For example, it has now occurred that we have been unable to fulfil all orders for item cat. no. 11176 HRÁBĚ (Su-25K), which is already sold out. It has only been on offer for three weeks and we are now considering whether to make a second edition.

If you would like to get more information, clarify some points or if you would need our help, please contact us at department@eduard.cz or contact me directly at jan.bobek@eduard.cz

Thank you for your kind attention and support!

Jan Bobek

Product previews are subject of change.

Instruction sheets,
more pictures and information
can be found on www.eduard.com

This leaflet can be downloaded from on www.eduard.com

eduard

PLASTIC KITS



82204 **FM-1 Wildcat**
1/48 ProfiPACK

DETAIL



8067 **P-39N Airacobra**
1/48 ProfiPACK

DETAIL



84196 **Bf 109E-4**
1/48 Weekend

DETAIL



7472 **Avia S-199 ERLA canopy**
1/72 Weekend

DETAIL



8079 **X-1 Mach Buster**
1/48 ProfiPACK **Re-release**

DETAIL



82117 **Bf 109G-4**
1/48 ProfiPACK **Re-release**

DETAIL



7406 **Albatros D.V**
1/72 Weekend **Re-release**

DETAIL

MASKS

JX320	AH-1G	1/35	ICM
JX321	AH-1G TFace	1/35	ICM
EX991	Seafire F.XVII	1/48	Airfix
EX992	Seafire F.XVII TFace	1/48	Airfix
EX993	Mi-17	1/48	Trumpeter
EX994	Mi-17 TFace	1/48	Trumpeter
EX995	Bf 109E-4 TFace	1/48	Eduard
EX996	F6F-3 US national insignia	1/48	Eduard
CX656	S-199 Erla canopy Weekend	1/72	Eduard

SPACE

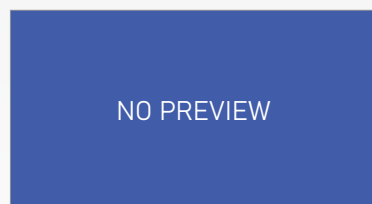

3DL32021 **AH-1G early SPACE**
1/35 ICM
(2 parts)

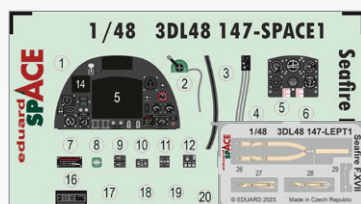

3DL48147 **Seafire F.XVII SPACE**
1/48 Airfix
(2 parts)

DETAIL

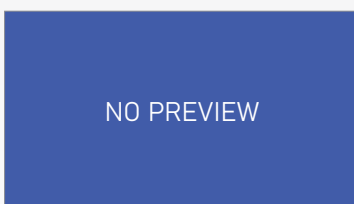

3DL48148 **Mi-17 SPACE**
1/48 Trumpeter
(2 parts)

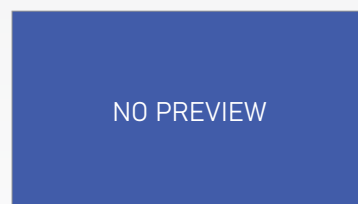

3DL48149 **FM-1 SPACE**
1/48 Eduard
(2 parts)

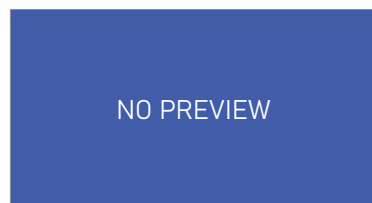

3DL48150 **P-39N SPACE**
1/48 Eduard
(2 parts)

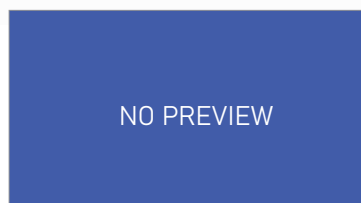

3DL48151 **X-1 SPACE**
1/48 Eduard
(2 parts)

PHOTO-ETCHED SETS

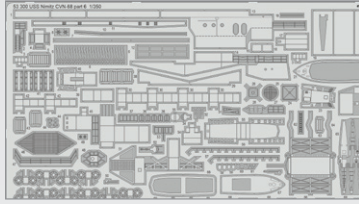

53300 USS Nimitz CVN-68 part 6
1/350 Trumpeter
(1 part)

DETAIL

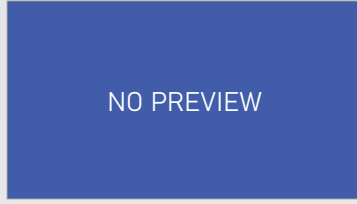

53301 USS Nimitz CVN-68 part 7
1/350 Trumpeter
(1 part)

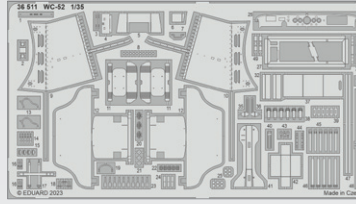

36511 WC-52
1/35 Zvezda
(1 part)

DETAIL

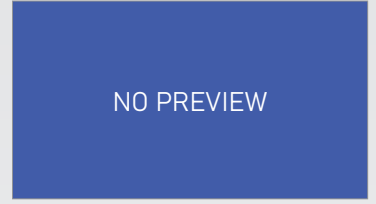

36512 BMP-3
1/35 Zvezda
(1 part)

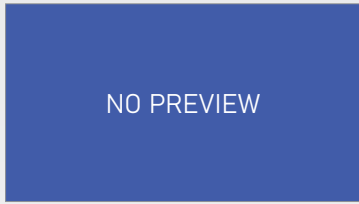

321015 AH-1G early
1/35 ICM
(2 parts)

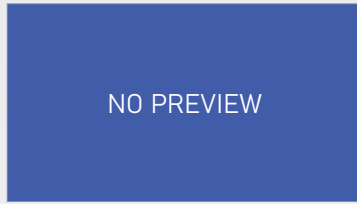

481125 FM-1 landing flaps
1/48 Eduard
(1 part)

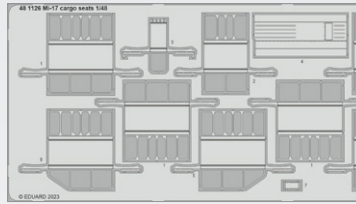

481126 Mi-17 cargo seats
1/48 Trumpeter
(1 part)

DETAIL

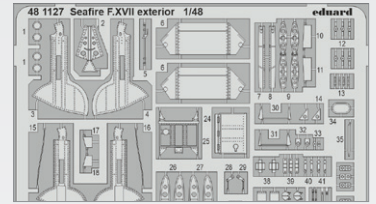

481127 Seafire F.XVII exterior
1/48 Airfix
(1 part)

DETAIL

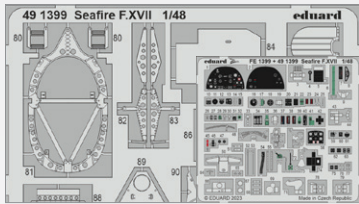

491399 Seafire F.XVII
1/48 Airfix
(2 parts)

DETAIL

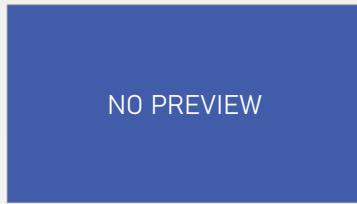

491401 Mi-17
1/48 Trumpeter
(2 parts)

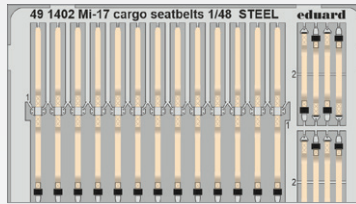

491402 Mi-17 cargo seatbelts STEEL
1/48 Trumpeter
(1 part)

DETAIL

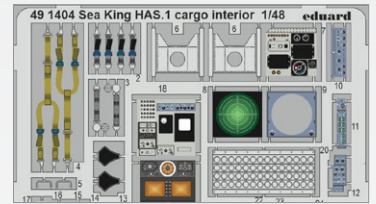

491404 Sea King HAS.1 cargo interior
1/48 Airfix
(1 part)

DETAIL

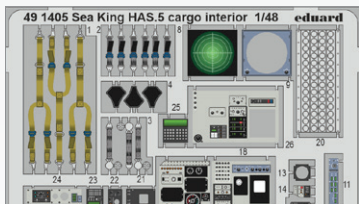

491405 Sea King HAS.5 cargo
interior 1/48 Airfix
(1 part)

DETAIL

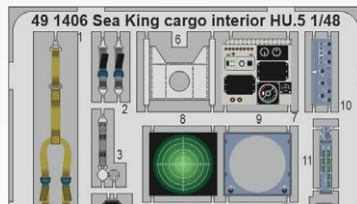

491406 Sea King HU.5 cargo
interior 1/48 Airfix
(1 part)

DETAIL

PHOTO-ETCHED SETS

ZOOM

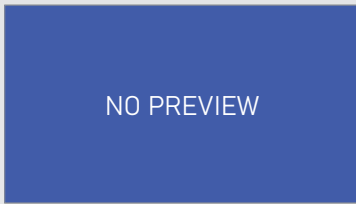

33361 AH-1G early
1/35 ICM
(1 part)

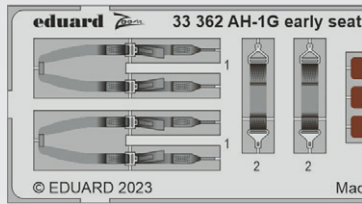

33362 AH-1G early seatbelts STEEL
1/35 ICM
(1 part)



FE1399 Seafire F.XVII
1/48 Airfix
(1 part)

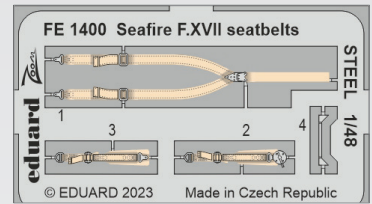

FE1400 Seafire F.XVII seatbelts STEEL
1/48 Airfix
(1 part)

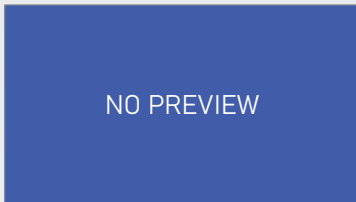

FE1401 Mi-17
1/48 Trumpeter
(1 part)

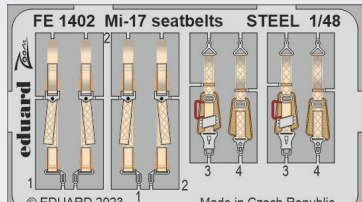

FE1402 Mi-17 seatbelts STEEL
1/48 Trumpeter
(1 part)

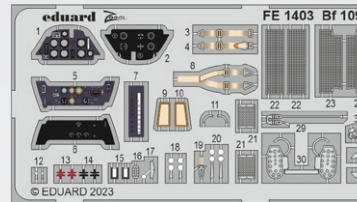

FE1403 Bf 109E-4 Weekend
1/48 Eduard
(1 part)

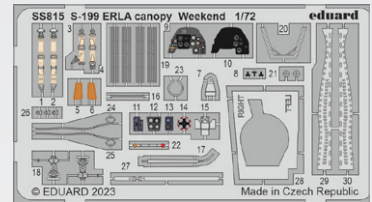

SS815 S-199 Erla canopy Weekend
1/72 Eduard
(1 part)

DECALS

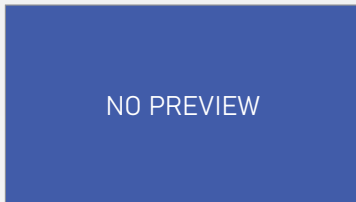

D48114 F-35A stencils
1/48 Tamiya
(1 part)

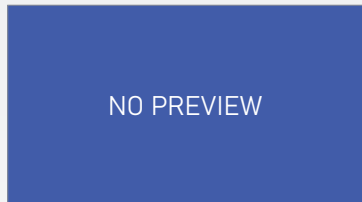

D72046 F-35A stencils
1/72 Tamiya
(1 part)

BIG ED SETS

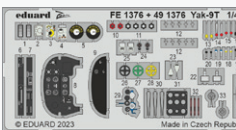

BIG49388 Yak-9T
1/48 Zvezda



BIG49389 F-4G
1/48 Meng



BIG72176 PBV-5A 1/72
Hobby 2000/Academy

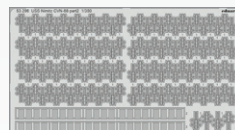

BIG5369 USS Nimitz CVN-68
PART I 1/350 Trumpeter

BRASSIN



644230 F-16D Block 50
LööK 1/48 Kinetic



644240 Fw 190A-7 LööK
1/48 Eduard



644241 FM-1 LööK
1/48 Eduard

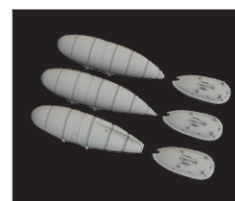

648906 Bf 109K external fuel tanks
1/48 Eduard

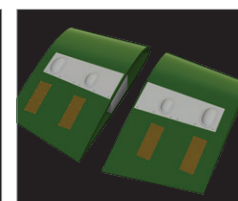

648938 Hurricane Mk.II gun bays PRINT
1/48 Arma Hobby



648940 Fw 190A-7 cockpit PRINT
1/48 Eduard

BRASSIN

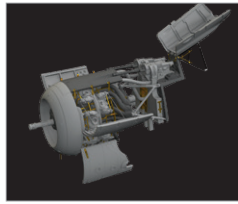

648941 Fw 190A-7 engine & fuselage guns 1/48 Eduard

DETAIL



648942 Fw 190A-7 undercarriage legs BRONZE 1/48 Eduard

DETAIL



648943 FM-1 undercarriage legs BRONZE 1/48 Eduard

DETAIL

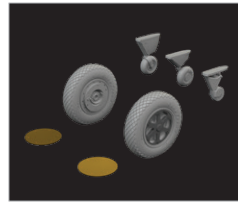

648944 FM-1 wheels 1/48 Eduard

DETAIL

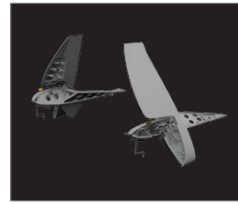

648945 FM-1 folding wings PRINT 1/48 Eduard

DETAIL



648946 FM-1 exhaust PRINT 1/48 Eduard

DETAIL

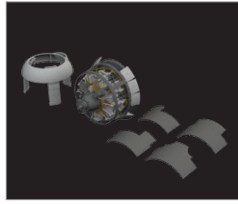

648947 FM-1 engine PRINT 1/48 Eduard

DETAIL

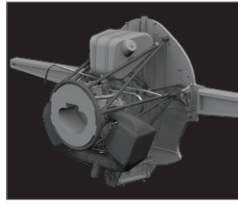

648948 FM-1 wheel bay PRINT 1/48 Eduard

DETAIL

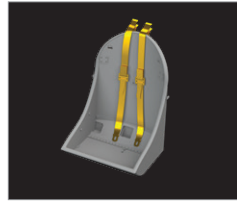

648949 FM-1 seat PRINT 1/48 Eduard

DETAIL

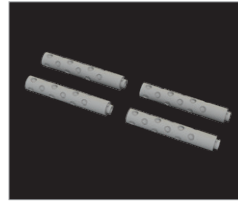

648950 FM-1 gun barrels PRINT 1/48 Eduard

DETAIL



672341 Bf 109G-2/G-4 wheels for bulged wings PRINT 1/72 Eduard

DETAIL

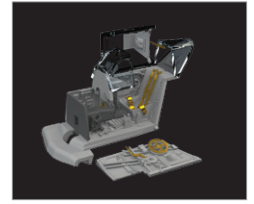

672342 Bf 109G-2 cockpit PRINT 1/72 Eduard

DETAIL

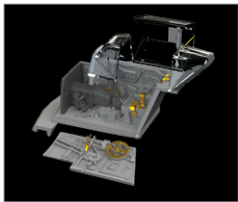

672343 Bf 109G-4 cockpit PRINT 1/72 Eduard

DETAIL

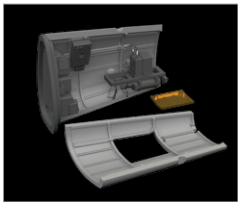

672344 Bf 109G radio compartment PRINT 1/72 Eduard

DETAIL

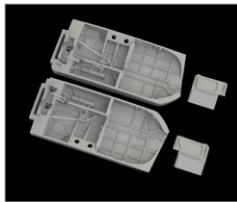

672345 F6F wheel bays PRINT 1/72 Eduard

DETAIL

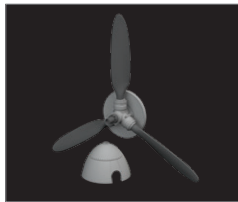

672346 Bf 109G propeller PRINT 1/72 Eduard

DETAIL

LööKplus

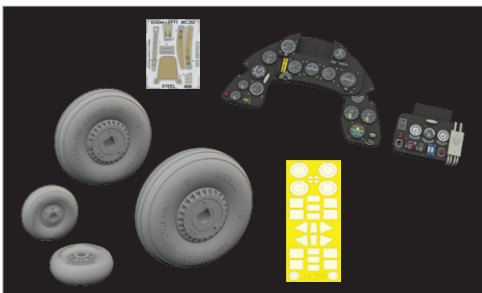

634045 MC.202 LööKplus 1/32 Italeri

DETAIL

LööKplus



644236 MiG-17F LööKplus 1/48 AMMO

DETAIL

LööKplus

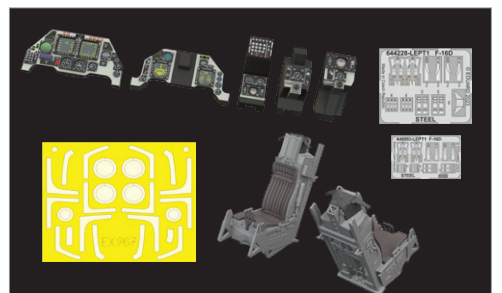

644237 F-16D Block 30 LööKplus 1/48 Kinetic

DETAIL

BIGSIN



SIN648115 FM-2 w/ armoured headrest ESSENTIAL 1/48 Eduard

DETAIL

BIGSIN

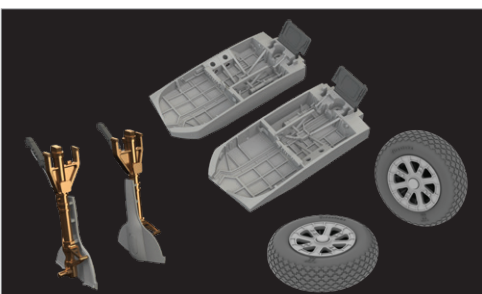

SIN648117 F6F undercarriage 1/48 Eduard

DETAIL

The ProfiPACK edition kit of US WWII aircraft carrier-based fighter FM-1 Wildcat in 1/48 scale. Kit presents FM-1 Wildcats from US Navy combat over the Pacific and the Atlantic, and also from the British FAA.

BASIC INFO:

NAME: **FM-1 Wildcat**

CAT. NO.: 82204

SCALE: 1/48

EDITION: ProfiPACK

CONTENTS:

SPRUES: Eduard

PE-SETS: Yes, pre-painted

PAINTING MASK: Yes

MARKING OPTIONS: 6

BRASSIN: No

RELATED PRODUCTS:

644241 FM-1 LööK (Brassin)

648943 FM-1 undercarriage legs BRONZE (Brassin)

648944 FM-1 wheels (Brassin)

648945 FM-1 folding wings PRINT (Brassin)

648946 FM-1 exhaust PRINT (Brassin)

648947 FM-1 engine PRINT (Brassin)

648948 FM-1 wheel bay PRINT (Brassin)

648949 FM-1 seat PRINT (Brassin)

648950 FM-1 gun barrels PRINT (Brassin)

3DL48149 FM-1 SPACE (3D Decal Set)

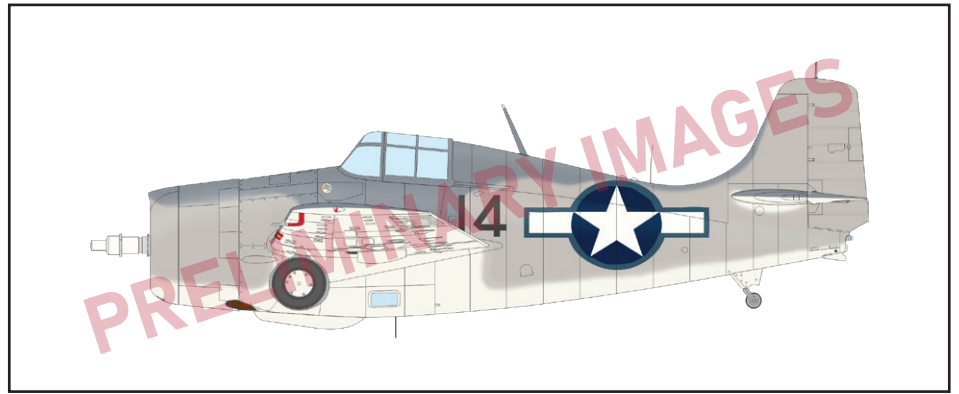

KIT PARTS

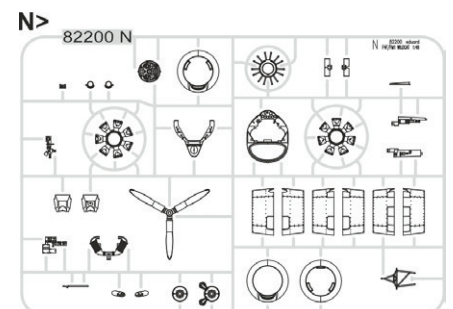
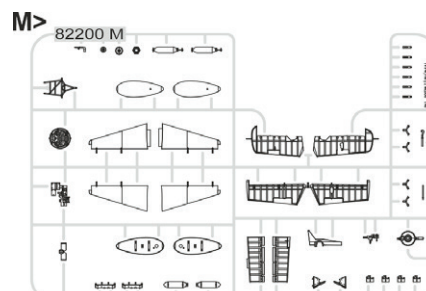
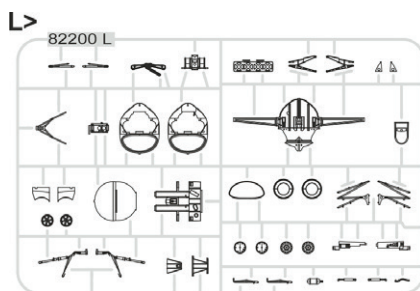
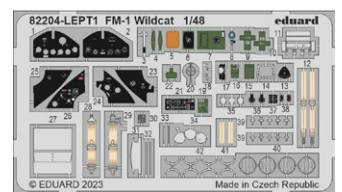
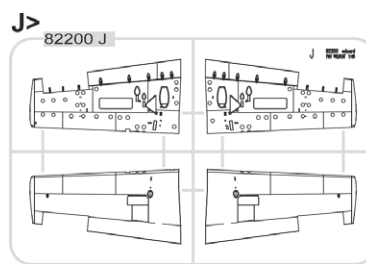
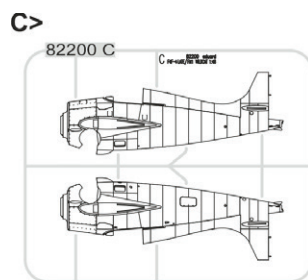
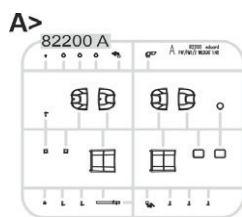



The ProfiPACK edition kit of US WWII fighter aircraft P-39N Airacobra in 1/48 scale. Kit offers P-39 from service with the American, Italian and Soviet air forces.

BASIC INFO:

NAME: **P-39N Airacobra**

CAT. NO.: 8067

SCALE: 1/48

EDITION: ProfiPACK

CONTENTS:

SPRUES: Eduard

PE-SETS: Yes, pre-painted

PAINTING MASK: Yes

MARKING OPTIONS: 6

BRASSIN: No

RELATED PRODUCTS:

49238 P-39Q/N (PE-Set)

648202 P-39 wheels early (Brassin)

648203 P-39 wheels late (Brassin)

3DL48150 P-39N SPACE (3D Decal Set)

D48068 P-39 stencils (Decal Set)

EX702 P-39/P-400 TFace (Mask)

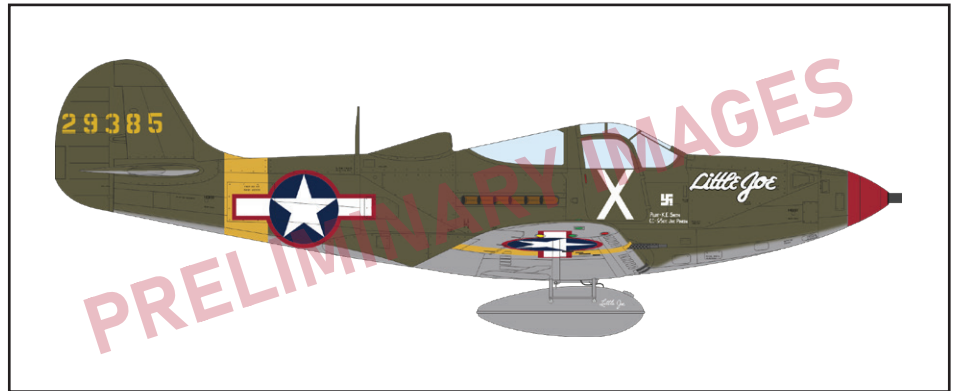

KIT PARTS

A>

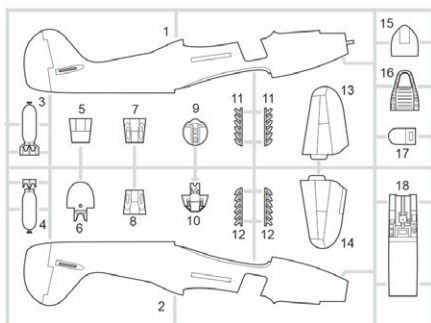

B>

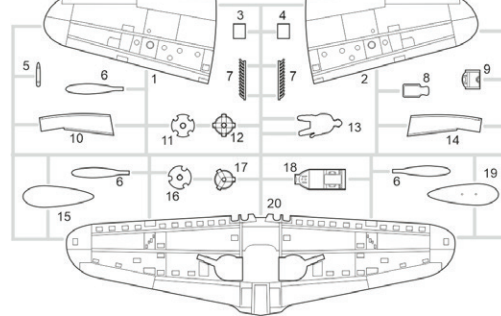

E>

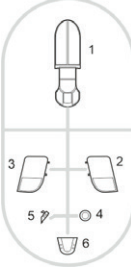

C>

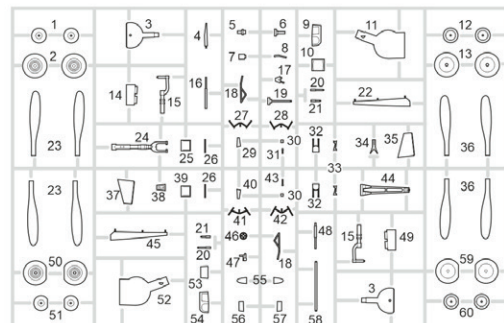

D>



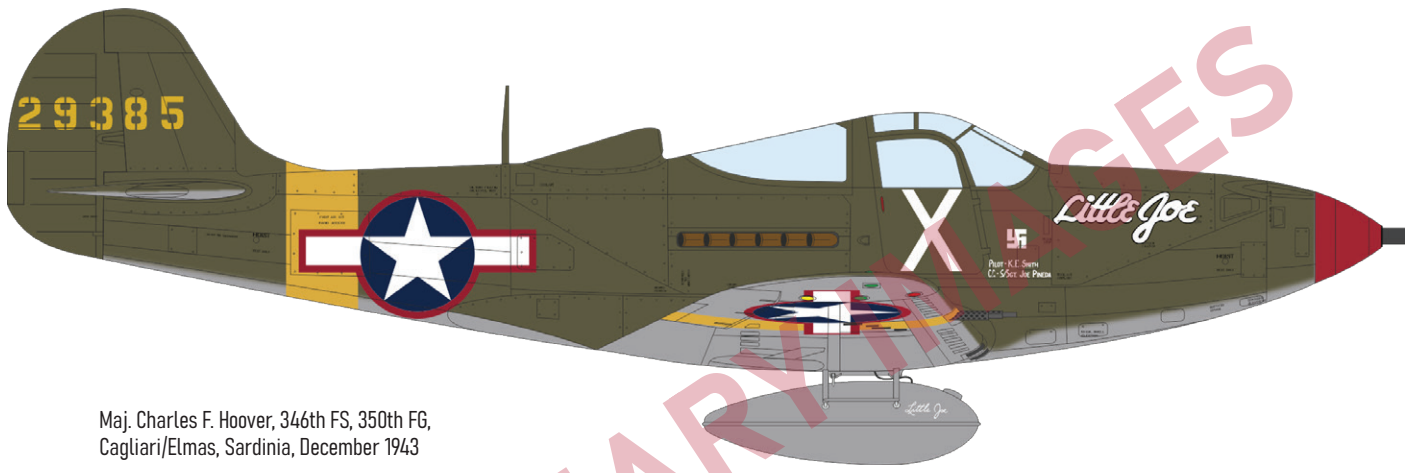

Maj. Charles F. Hoover, 346th FS, 350th FG,
Cagliari/Elmas, Sardinia, December 1943

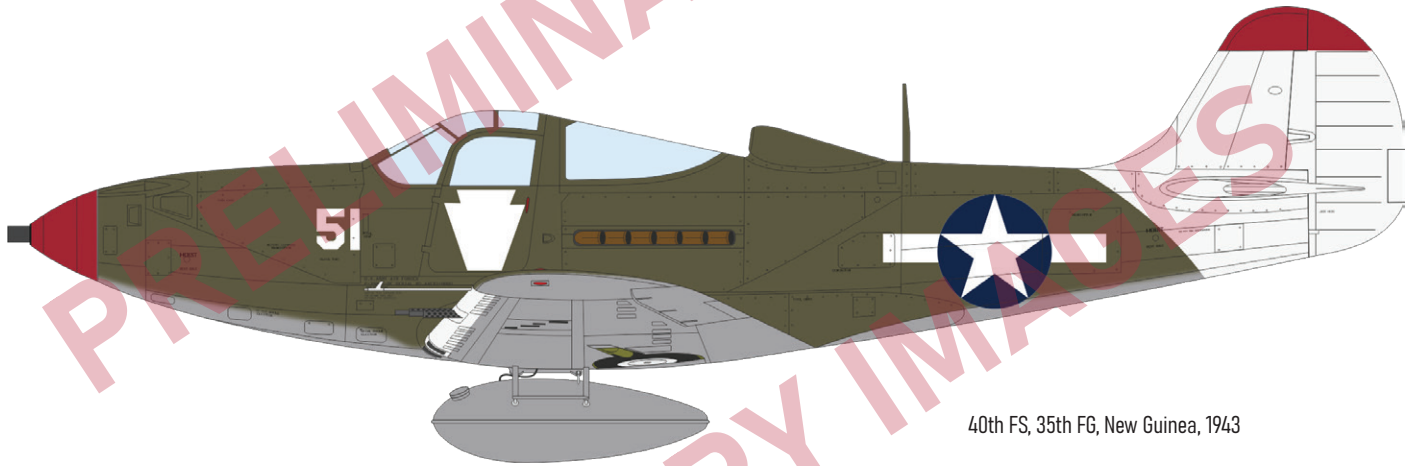

40th FS, 35th FG, New Guinea, 1943

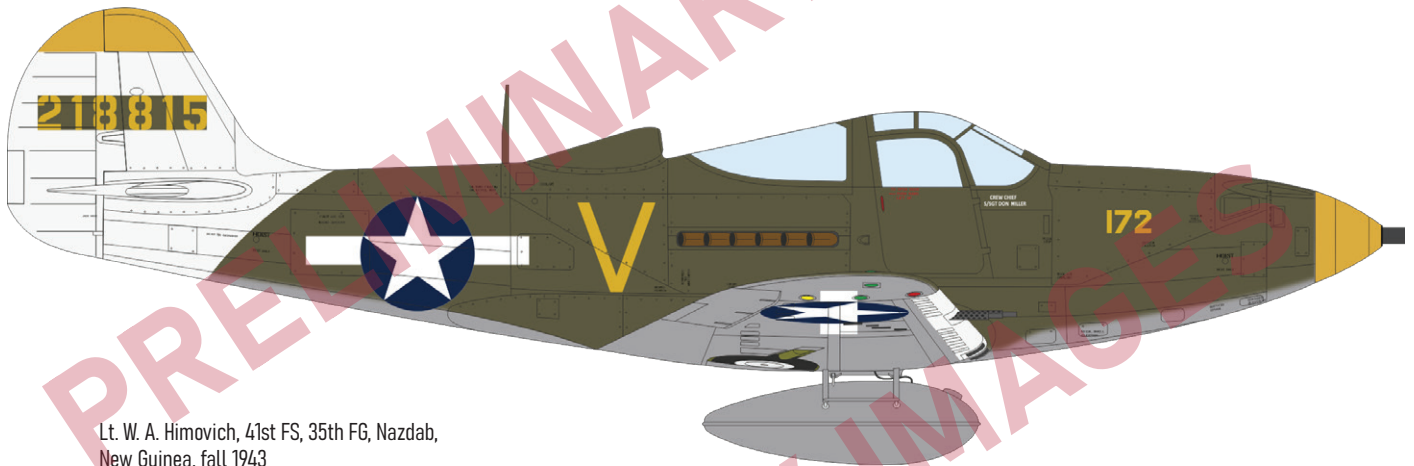

Lt. W. A. Himovich, 41st FS, 35th FG, Nazdab,
New Guinea, fall 1943

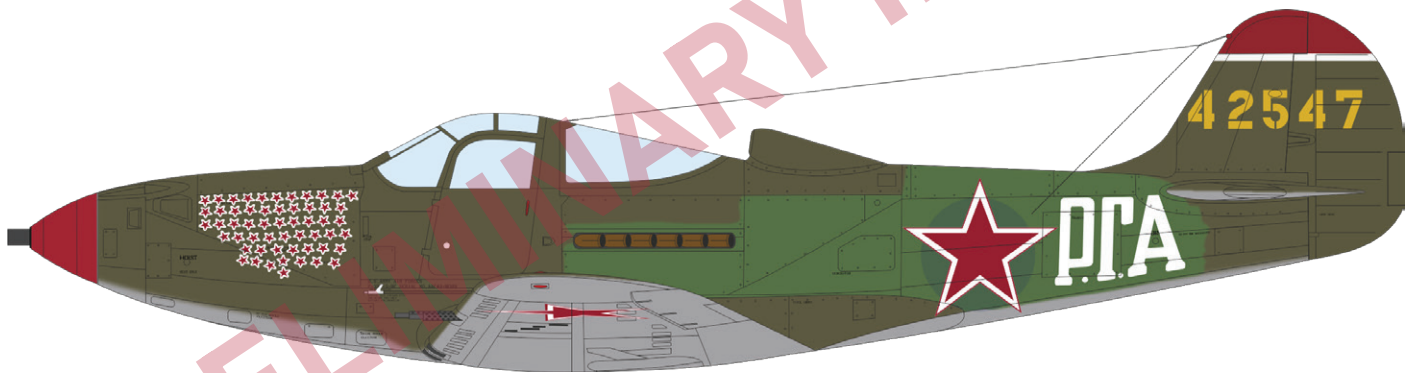

Guard Capt. Grigoriy Andreevich Rechkalov,
16 GIAP, August 1944

+ two more marking options

The Weekend edition kit of German WWII fighter aircraft Bf 109E-4 in 1/48 scale.

BASIC INFO:

NAME: **Bf 109E-4**

CAT. NO.: 84196

SCALE: 1/48

EDITION: Weekend edition

CONTENTS:

SPRUES: Eduard

PE-SETS: No

PAINTING MASK: No

MARKING OPTIONS: 4

BRASSIN: No

RELATED PRODUCTS:

FE1403 Bf 109E-4 Weekend (PE-Set)

644024 Bf 109E LööK (Brassin)

648058 Bf 109E wheels (Brassin)

648472 Bf 109E cockpit & radio compartment (Brassin)

648474 Bf 109E engine (Brassin)

3DL48049 Bf 109E-4 SPACE (3D Decal Set)

EX400 Bf 109E-4/E-7 Weekend (Mask)

EX995 Bf 109E-4 TFace (Mask)

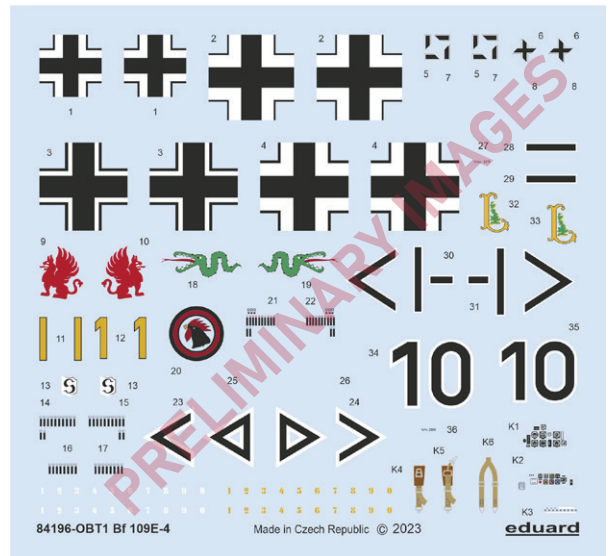
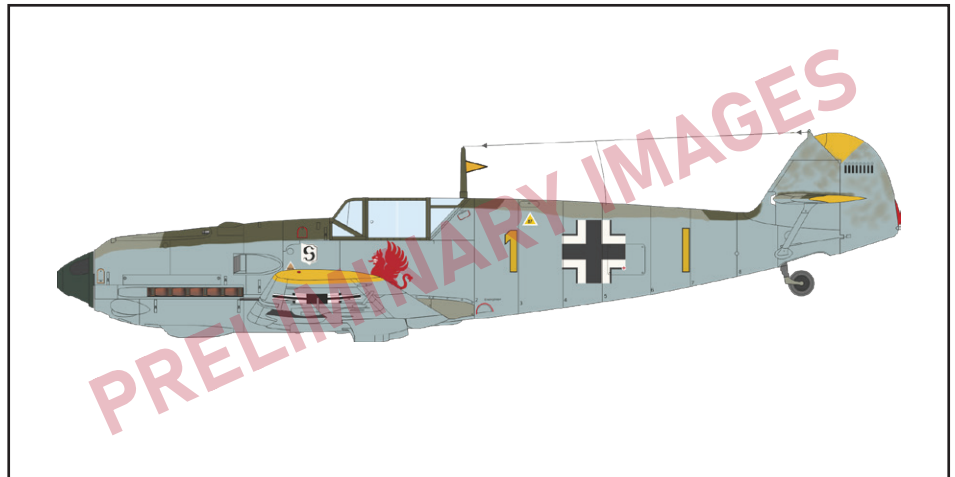

KIT PARTS

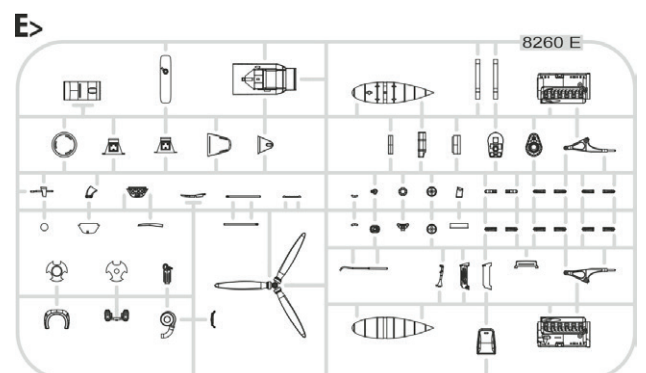
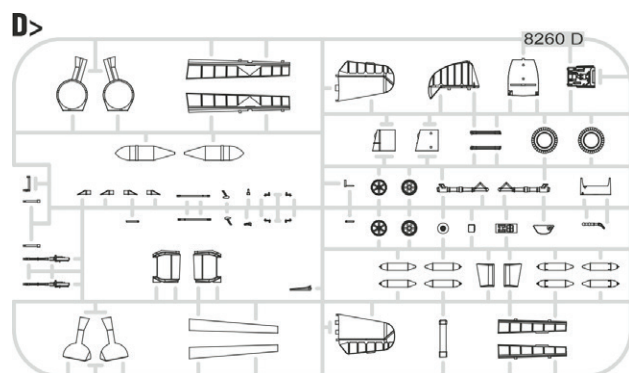
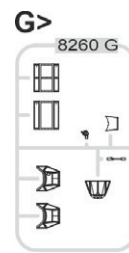
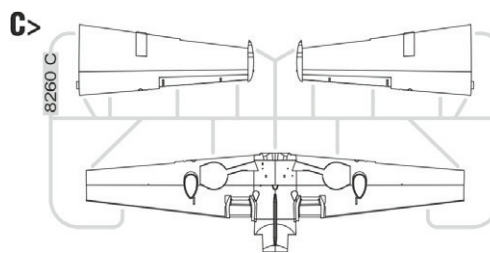
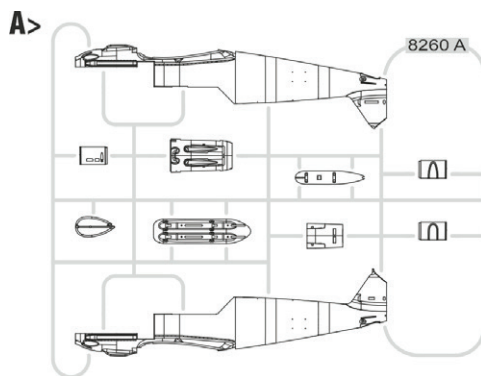

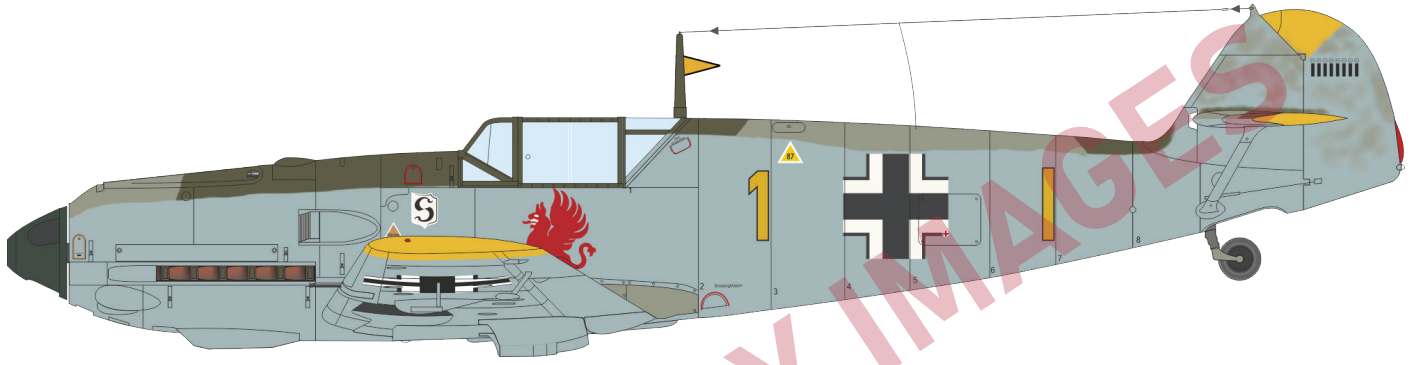

Bf 109E-4, Oblt. Gerhard Schöpfel, III. /JG 26,
Caffiers, France, August 1940

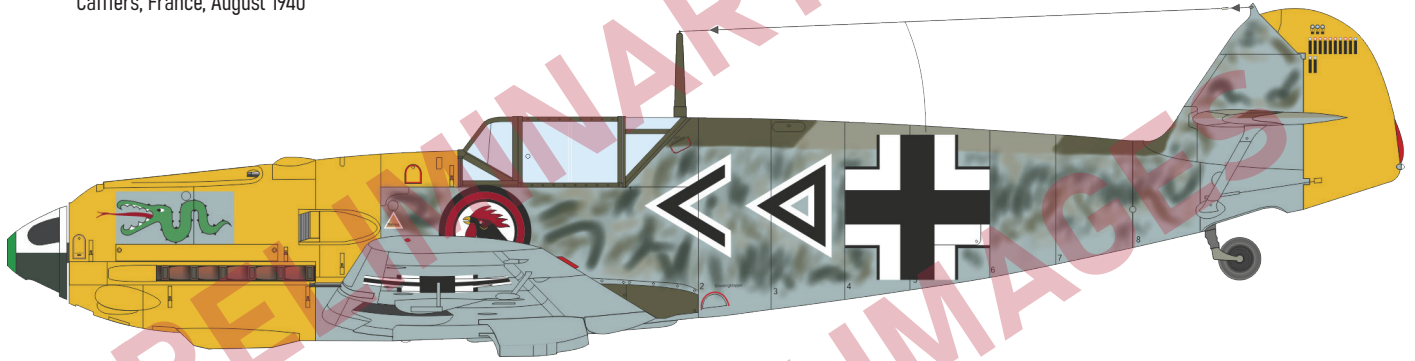

Bf 109E-4, W.Nr. 1433, Hptm. Hans von Hahn,
I./JG 3, Grandvillers, France, September 1940

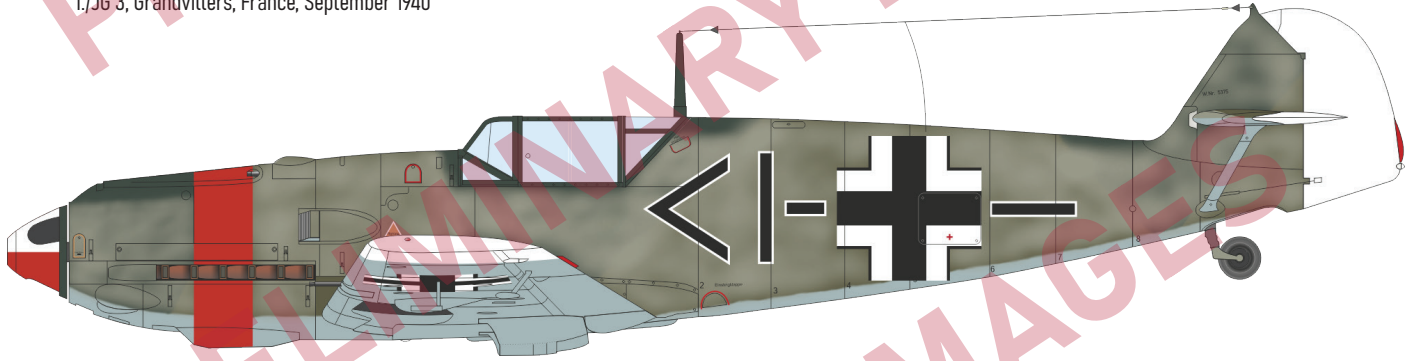

Bf 109E-4, W.Nr. 5375, Hptm. Wilhelm Meyerweissflog,
Stab. JG 53, Etaples, France, September 1940

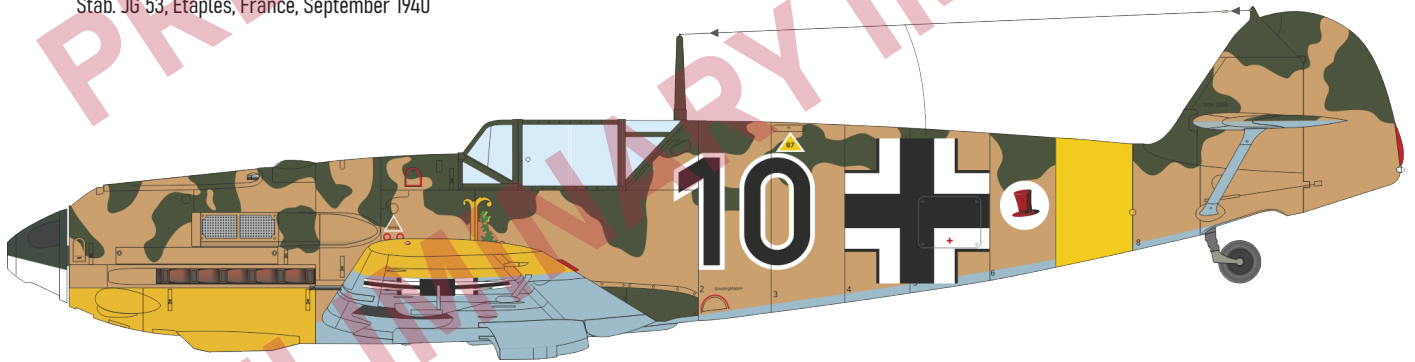

Bf 109E-4, W.Nr. 2060, Lt. Hans Guse, 2.(J)/LG 2,
USSR (today's Republic of Moldova), July 1941

The Weekend edition kit of Czechoslovak single engine fighter Avia S-199 with ERLA canopy in 1/72 scale. This type of aircraft was used by the Czechoslovak and Israeli air forces.

BASIC INFO:

NAME: **Avia S-199 ERLA canopy**

CAT. NO.: 7472

SCALE: 1/72

EDITION: Weekend edition

CONTENTS:

SPRUES: Eduard

PE-SETS: No

PAINTING MASK: No

MARKING OPTIONS: 4

BRASSIN: No

RELATED PRODUCTS:

672284 S-199 exhaust stacks PRINT (Brassin)

672285 S-199 wheels PRINT (Brassin)

672288 S-199 cockpit ERLA canopy PRINT (Brassin)

672293 S-199 4xETC 50 rack w/bombs (Brassin)

672294 S-199 engine PRINT (Brassin)

3DL72008 S-199 SPACE (3D Decal Set)

D72038 S-199 Czechoslovak national insignia (Decal Set)

D72039 S-199 Israeli national insignia (Decal Set)

D72040 S-199 Czechoslovak stencils (Decal Set)

D72041 S-199 Israeli stencils (Decal Set)

SS815 S-199 ERLA canopy Weekend (Mask)

CX656 S-199 ERLA canopy Weekend (Mask)

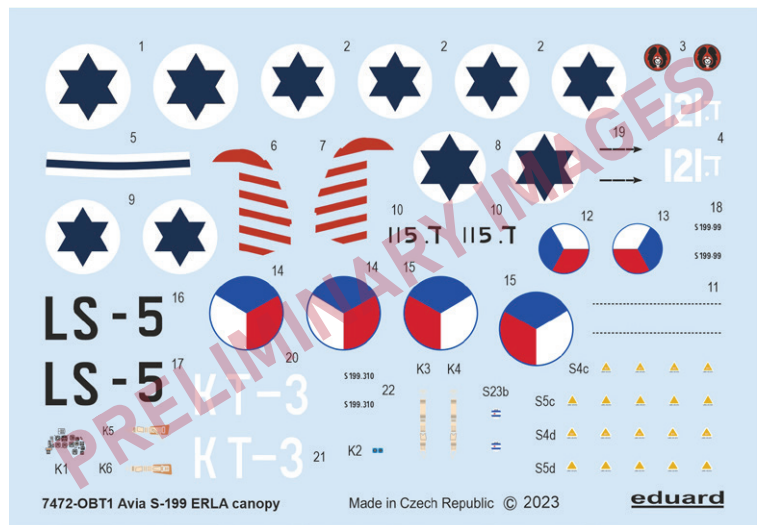
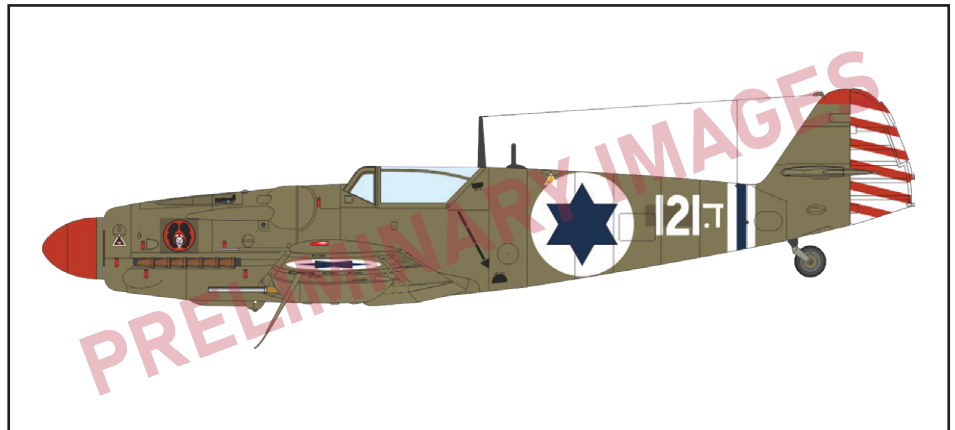

KIT PARTS

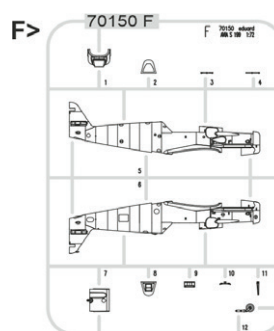
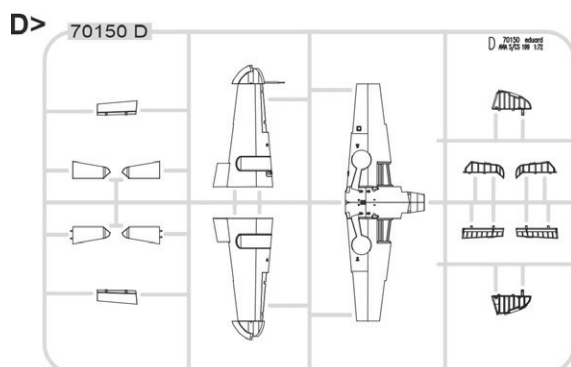
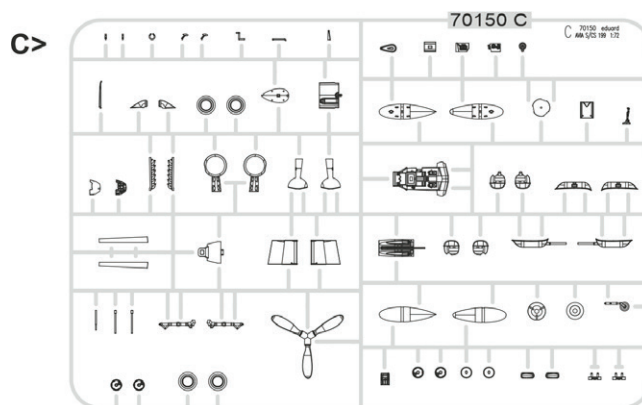
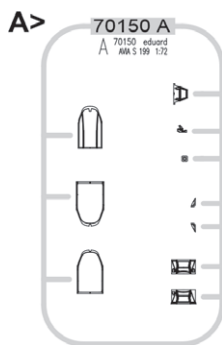

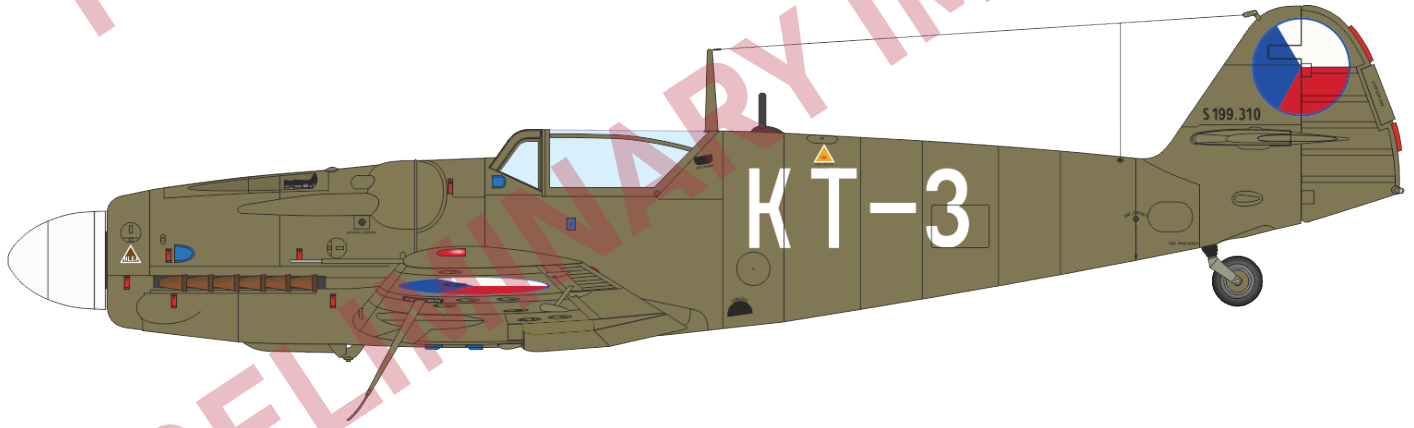
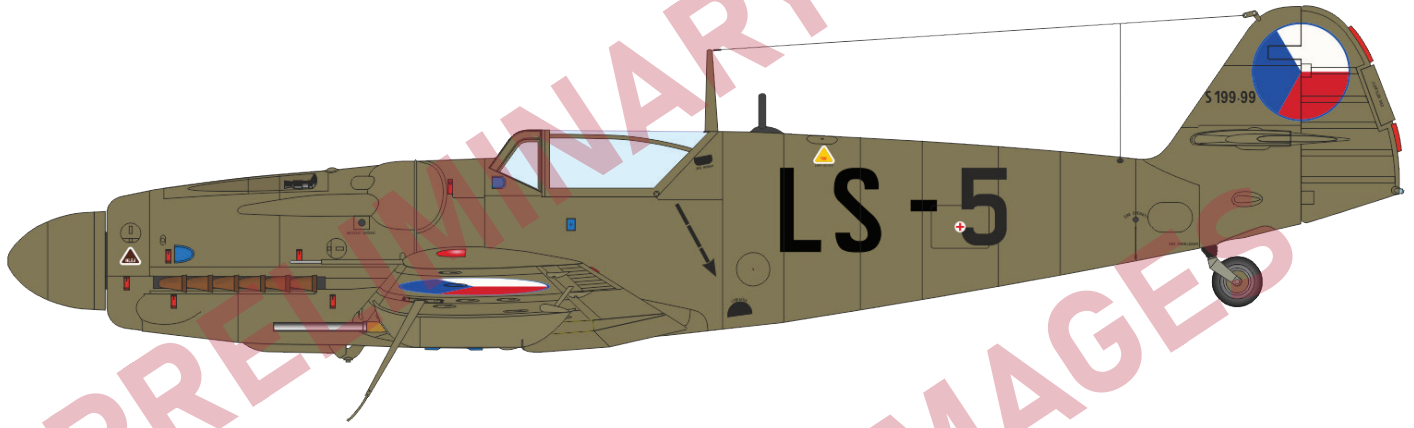
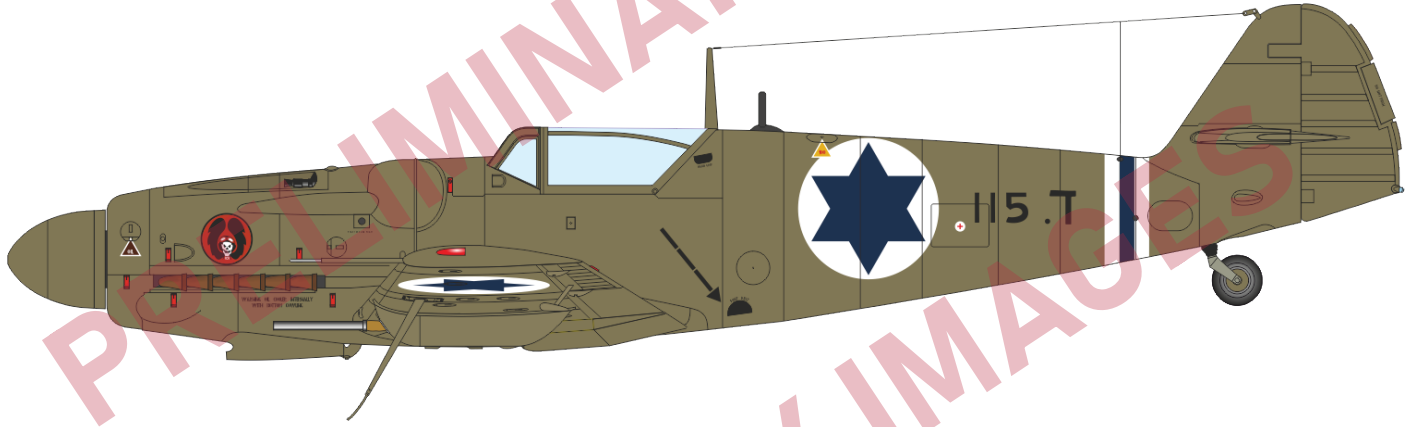
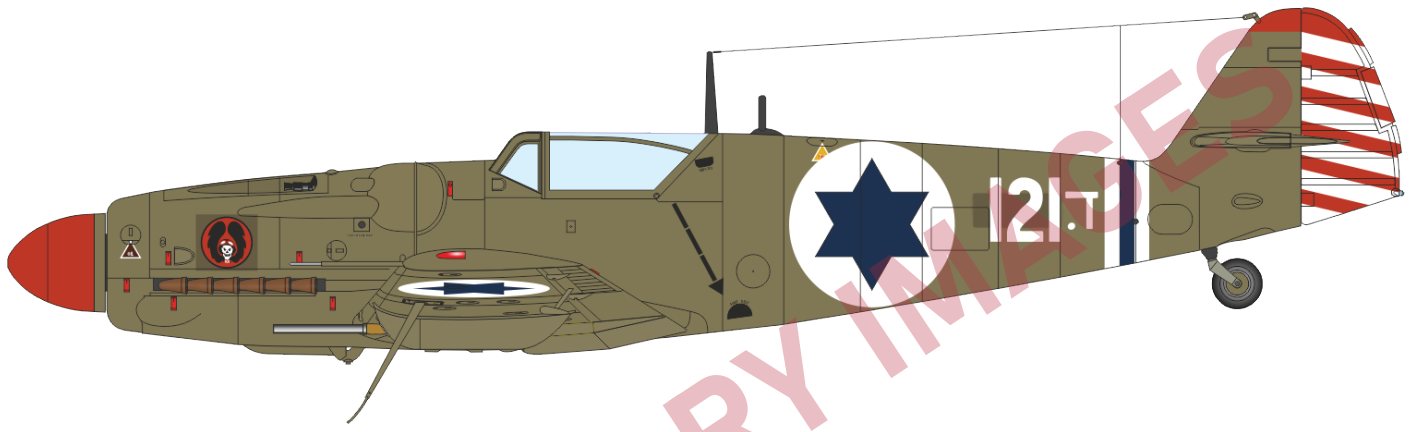

PRELIMINARY IMAGES

The ProfiPACK edition kit of famous rocket engine-powered aircraft Bell X-1 in 1/48 scale.

Re-release

BASIC INFO:

NAME: X-1 Mach Buster **Re-release**

CAT. NO.: 8079

SCALE: 1/48

EDITION: ProfiPACK

CONTENTS:

SPRUES: Eduard

PE-SETS: Yes, pre-painted

PAINTING MASK: Yes

MARKING OPTIONS: 4

BRASSIN: Yes, wheels

RELATED PRODUCTS:

48908 X-1 upgrade set (PE-Set)

3DL48151 X-1 SPACE (3D Decal Set)

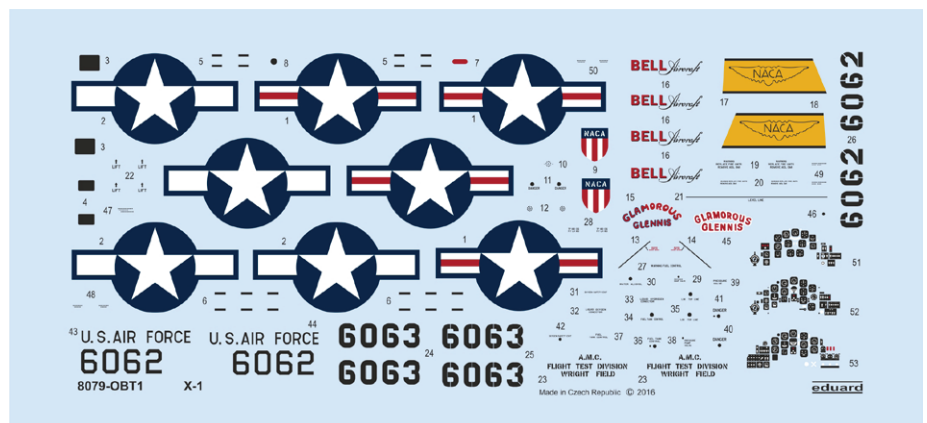
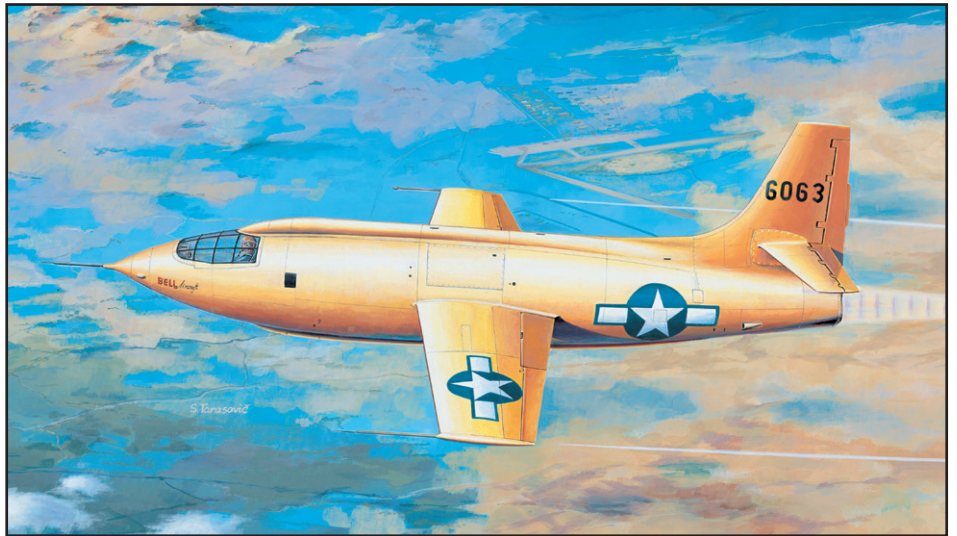

KIT PARTS

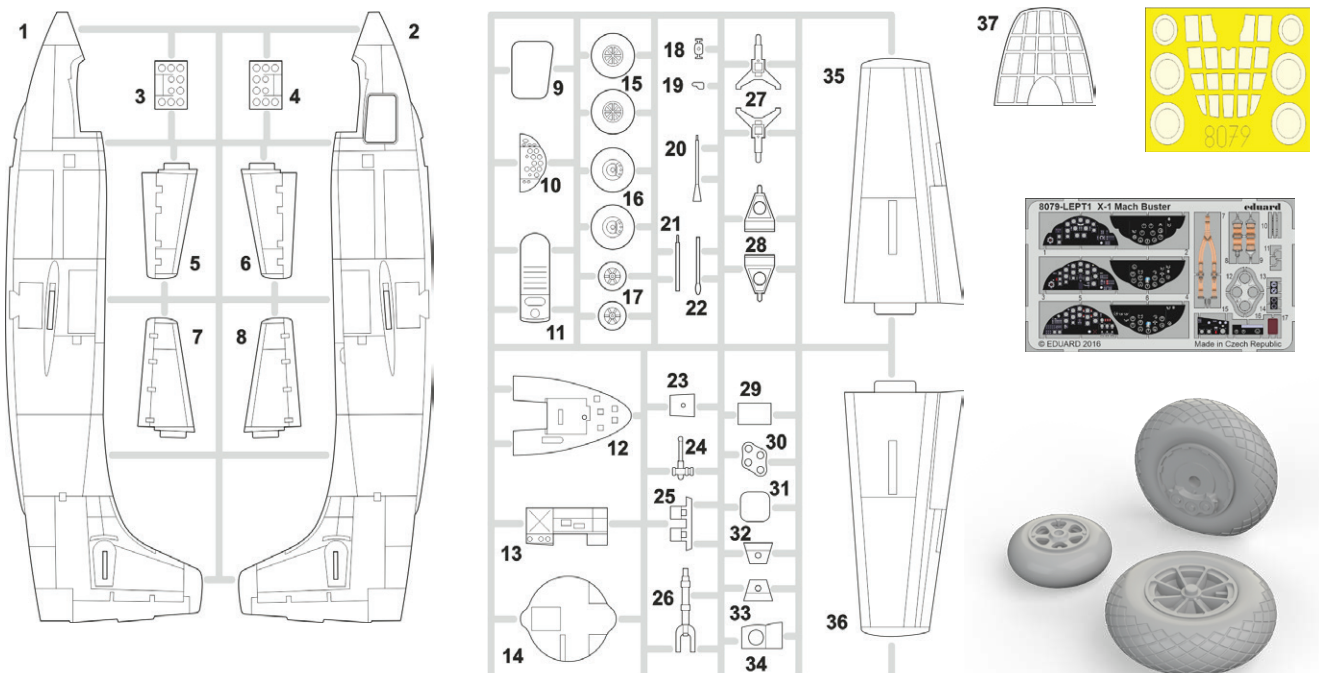

S/N 46-062, Muroc Dry Lake Base, 2nd half 1947

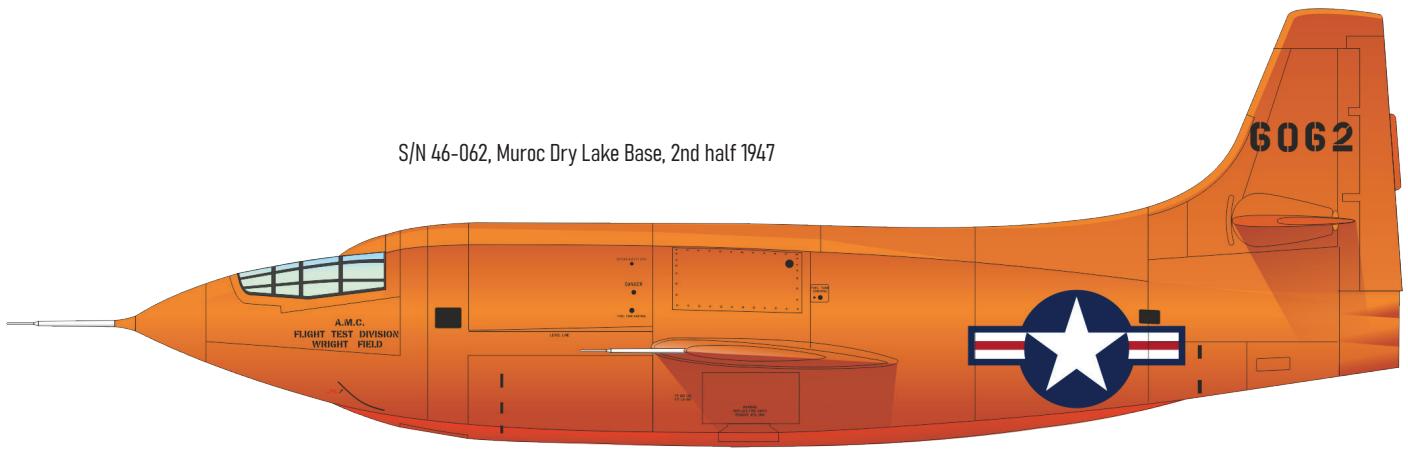

S/N 46-063, Muroc Dry Lake Base, late 1946

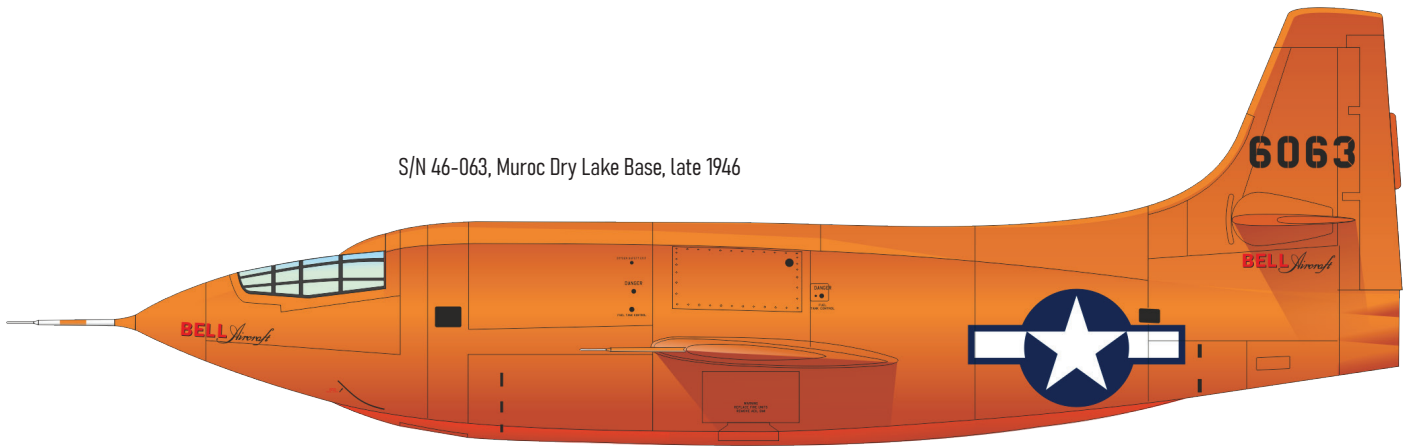

S/N 46-063, Edwards AFB, October 1947

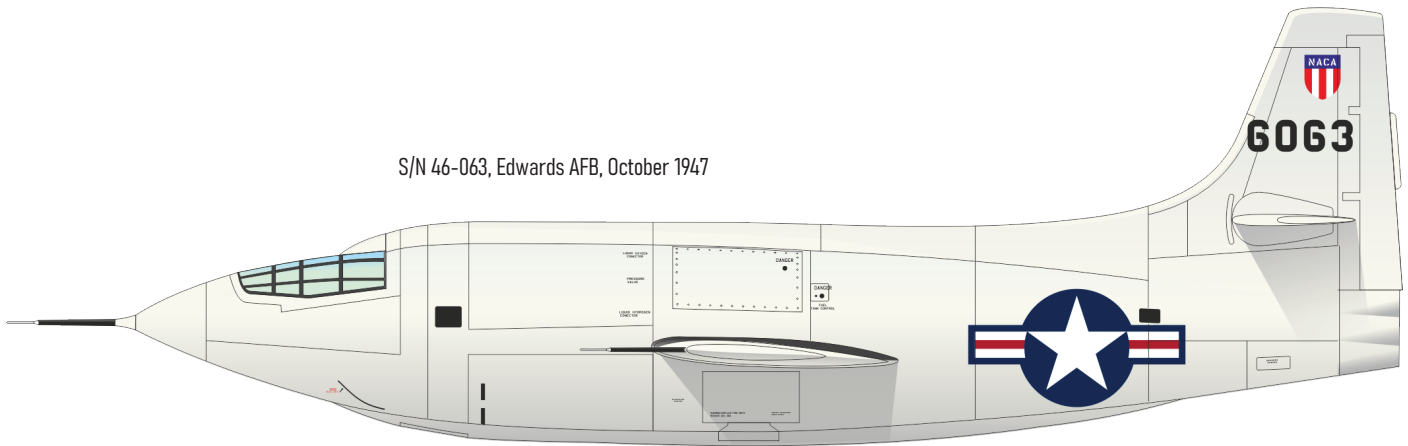

S/N 46-062, Edwards AFB, 1950

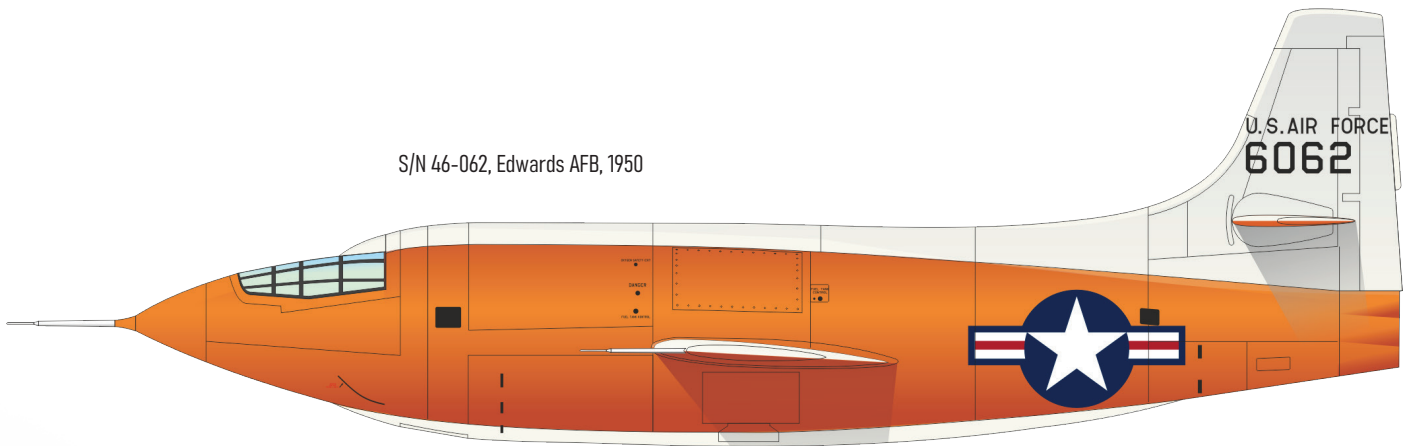

The ProfiPACK edition kit of German WWII fighter plane Bf 109G-4 in 1/48 scale.

Re-release

BASIC INFO:

NAME: **Bf 109G-4 Re-release**

CAT. NO.: 82117

SCALE: 1/48

EDITION: ProfiPACK

CONTENTS:

SPRUES: Eduard

PE-SETS: Yes, pre-painted

PAINTING MASK: Yes

MARKING OPTIONS: 5

BRASSIN: No



RELATED PRODUCTS:

FE910 Bf 109G seatbelts STEEL (PE-Set)

648247 Bf 109G exhaust stacks (Brassin)

648265 Bf 109G external fuel tanks (Brassin)

648309 Bf 109G undercarriage legs BRONZE (Brassin)

648720 Bf 109G-4 wheels (Brassin)

648935 Bf 109G-4 cockpit PRINT (Brassin)

EX558 Bf 109G-4 (Mask)

EX582 Bf 109G classic canopy TFace (Mask)

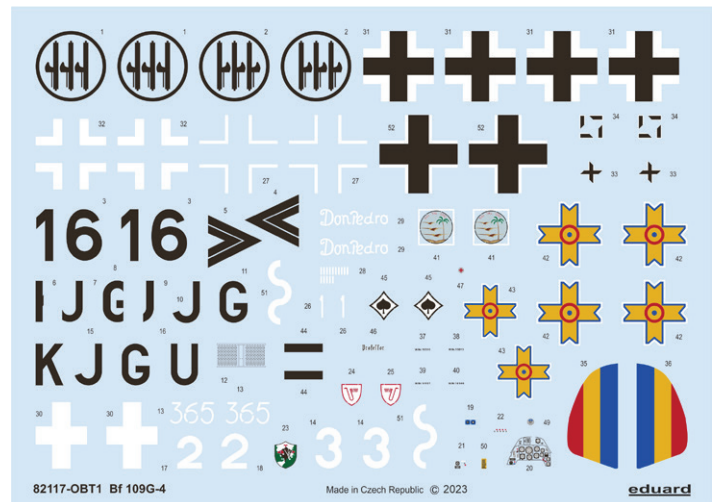

KIT PARTS

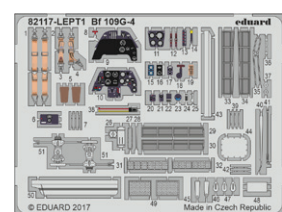
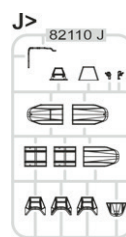
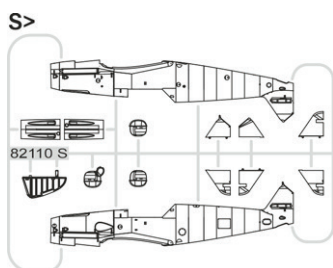
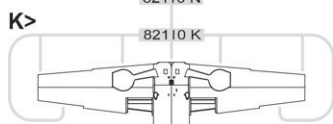
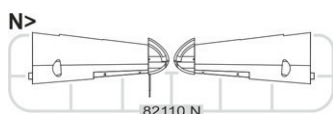
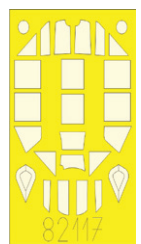
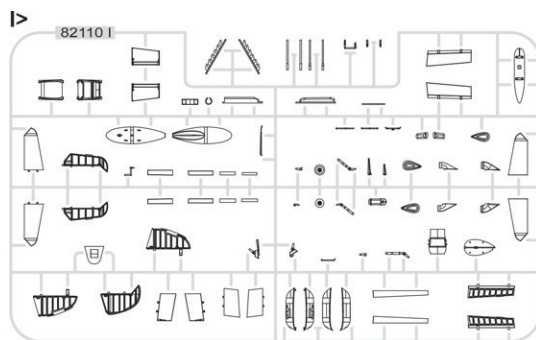
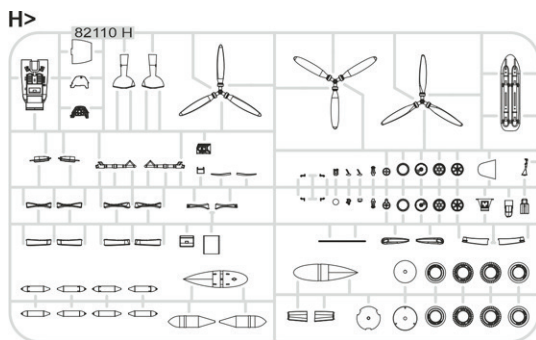

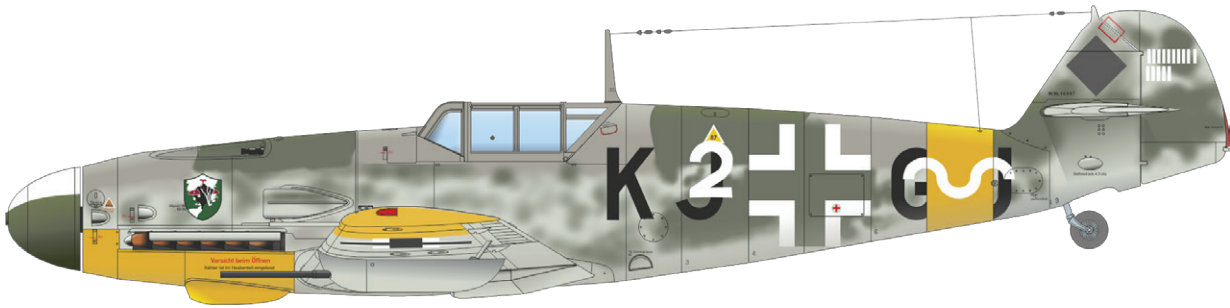

Bf 109G-4/R6, W. Nr. 14997, Lt. E. Hartmann, 7./JG 52, Taman, Soviet Union, May 1943

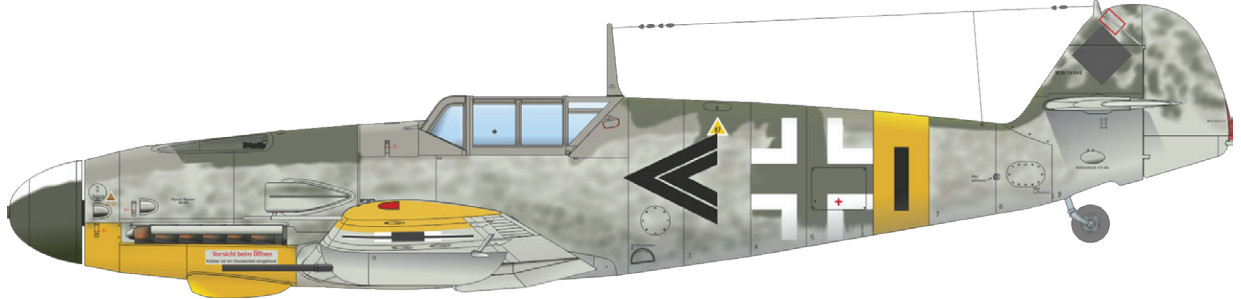

Bf 109G-4/R6, W. Nr. 14946, Maj. W. Ewald, Stab III./JG 3, Kertch, Soviet Union, April 1943

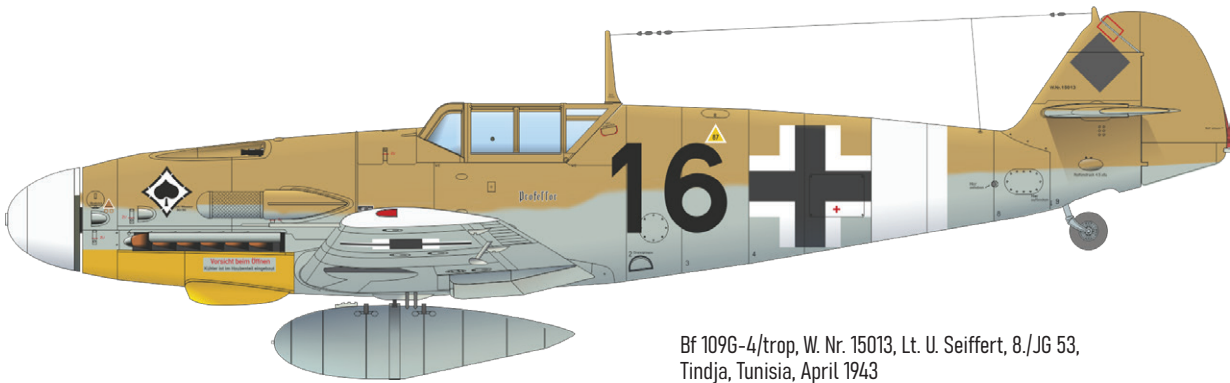

Bf 109G-4/trop, W. Nr. 15013, Lt. U. Seiffert, 8./JG 53, Tindja, Tunisia, April 1943

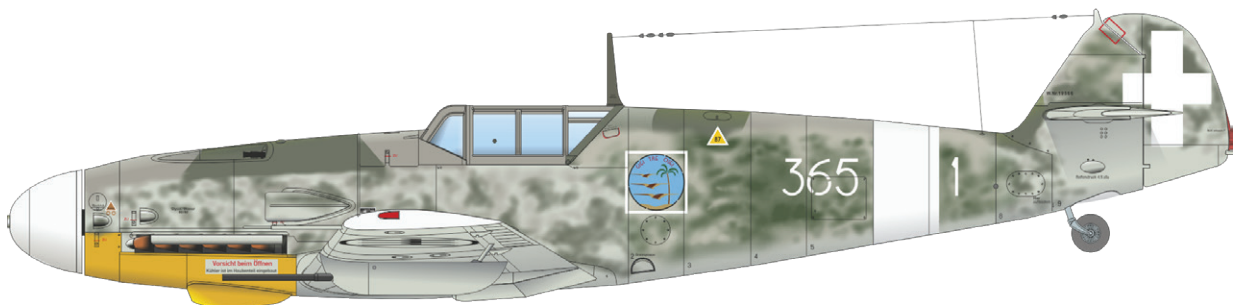

Bf 109G-4/R6, W. Nr. 19566, ten. G. Gianelli, 365ª Squadriglia, 150º Gruppo Autonomo, Sciacca, Sicily, July 1943

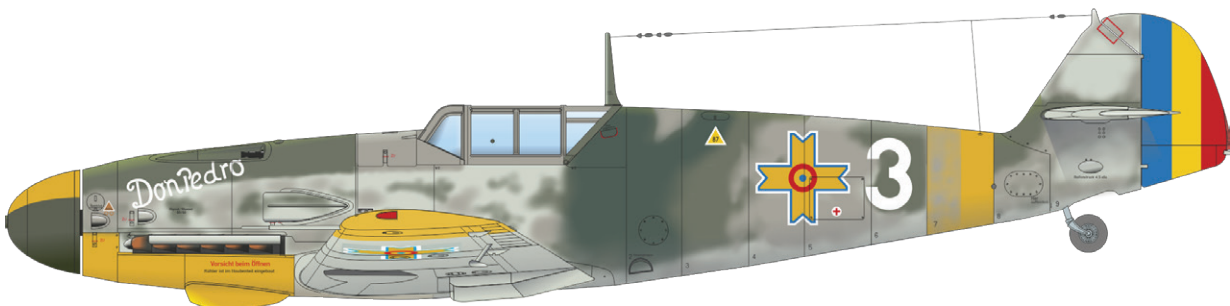

Bf 109G-4, Lt. Av. P. Protopopescu, Escadrila 57, Grupul 7 Vânătoare, Kirovograd (Kropyvnytskyi/ Ukraine now), Soviet Union, June 1943

The Weekend edition kit of German WWI fighter plane Albatros D.V in 1/72 scale.

Re-release

BASIC INFO:

NAME: **Albatros D.V**

CAT. NO.: 7406

SCALE: 1/72

EDITION: Weekend edition

CONTENTS:

SPRUES: Eduard

PE-SETS: No

PAINTING MASK: No

MARKING OPTIONS: 4

BRASSIN: No

RELATED PRODUCTS:

SS741 Albatros D.V Weekend (PE-Set)

CX600 Albatros D.V Weekend (Mask)

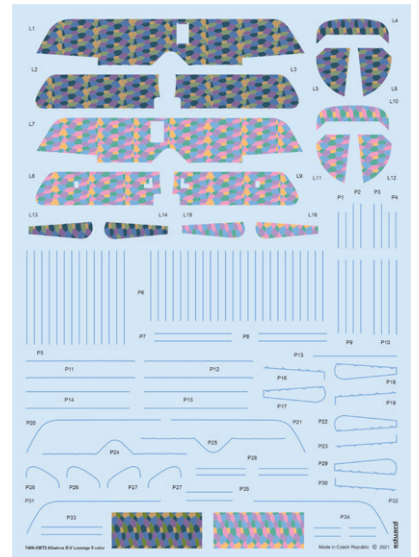
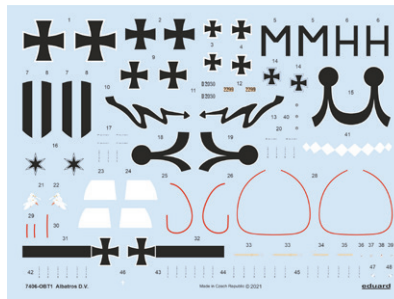

KIT PARTS

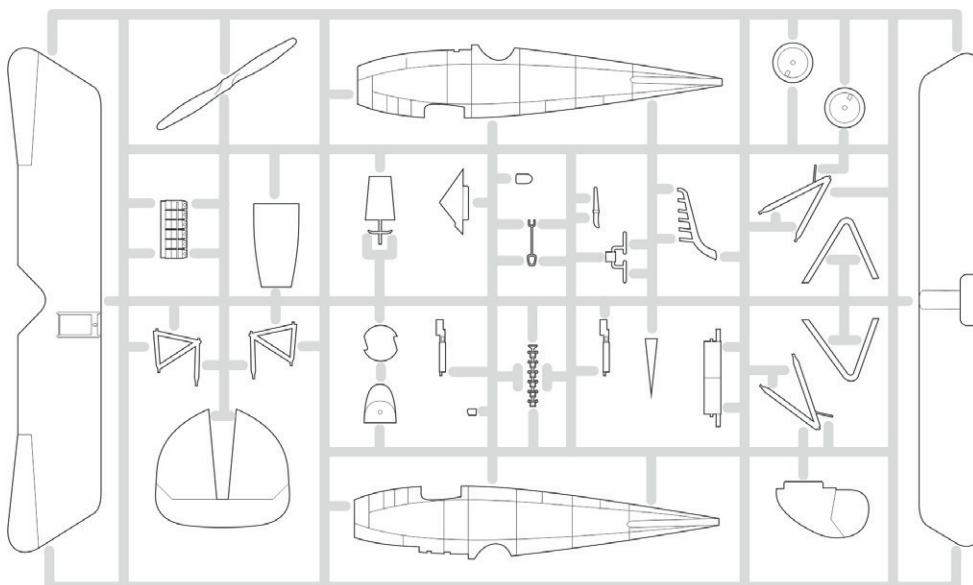



Albatros D.V 1154/17, Lt. Max Ritter von Müller, Jasta 28, Varsenare, Belgium, September 1917

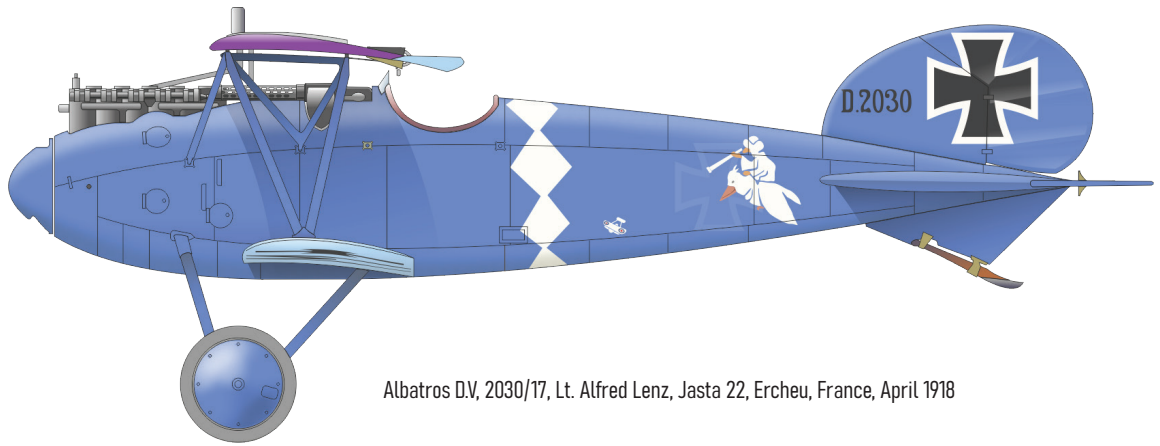

Albatros D.V, 2030/17, Lt. Alfred Lenz, Jasta 22, Ercheu, France, April 1918

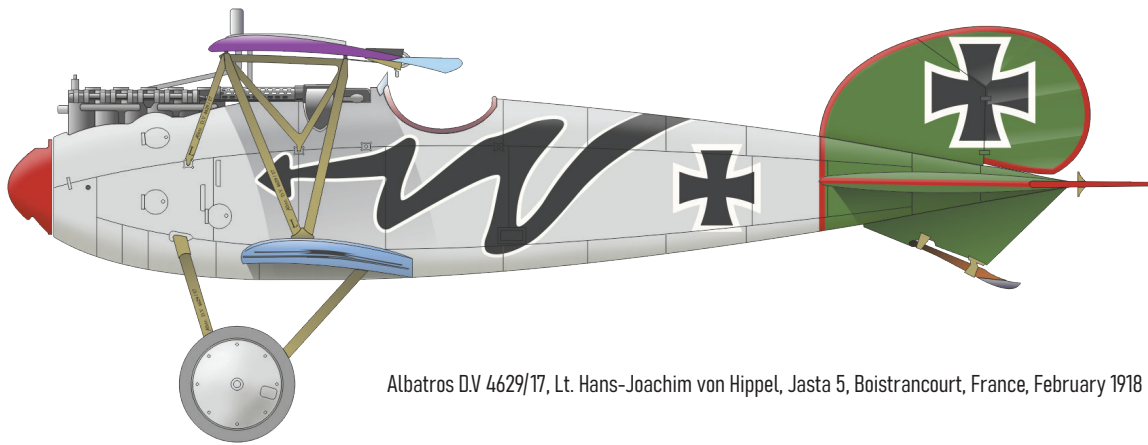

Albatros D.V 4629/17, Lt. Hans-Joachim von Hippel, Jasta 5, Boistrancourt, France, February 1918

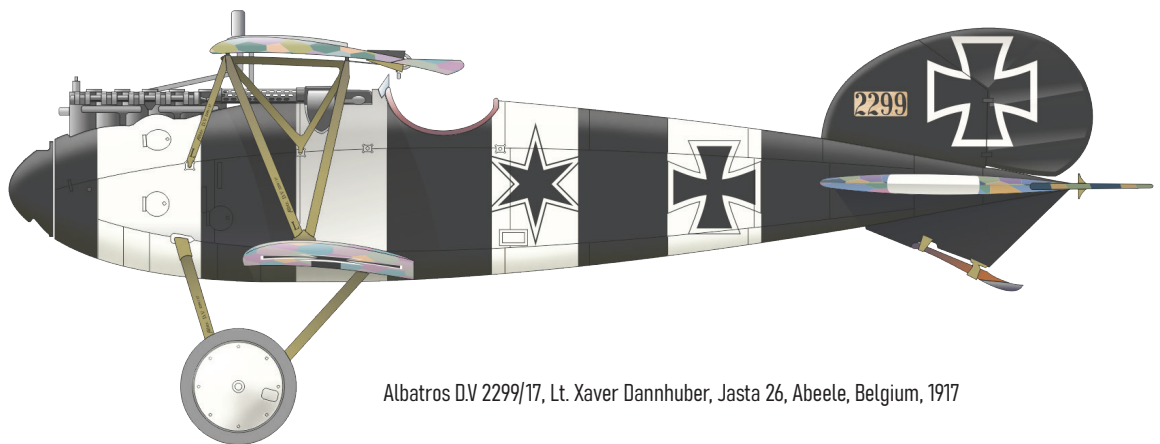

Albatros D.V 2299/17, Lt. Xaver Dannhuber, Jasta 26, Abeele, Belgium, 1917

53300 USS Nimitz CVN-68 part 6
1/350 Trumpeter

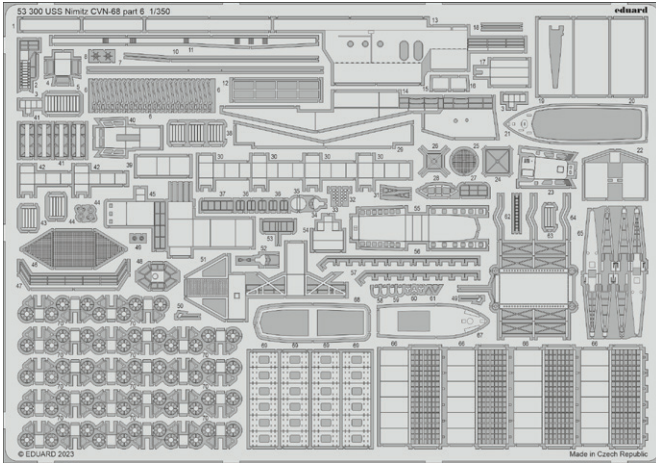

36511 WC-52
1/35 Zvezda

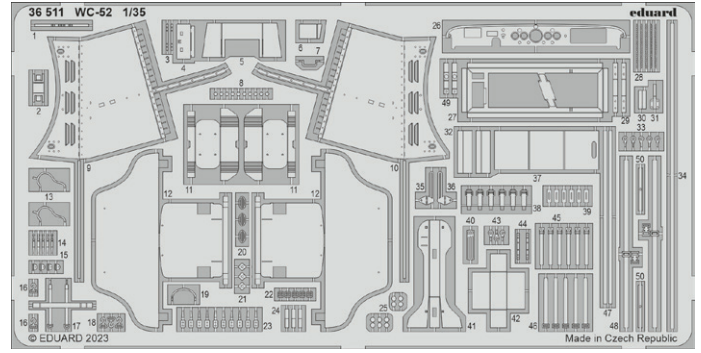

481126 Mi-17 cargo seats
1/48 Trumpeter

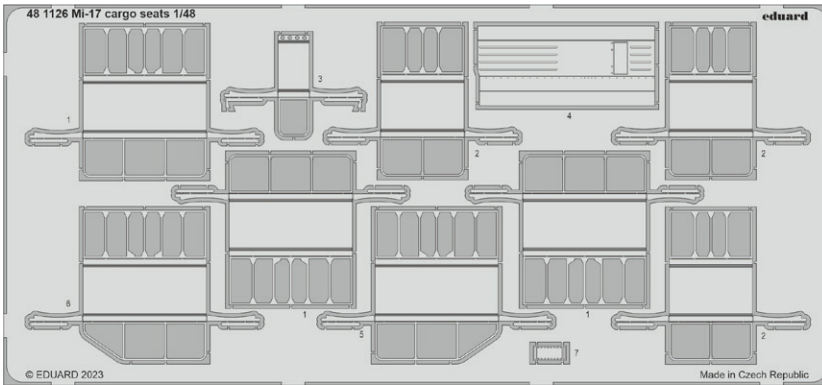

481127 Seafire F.XVII exterior
1/48 Airfix

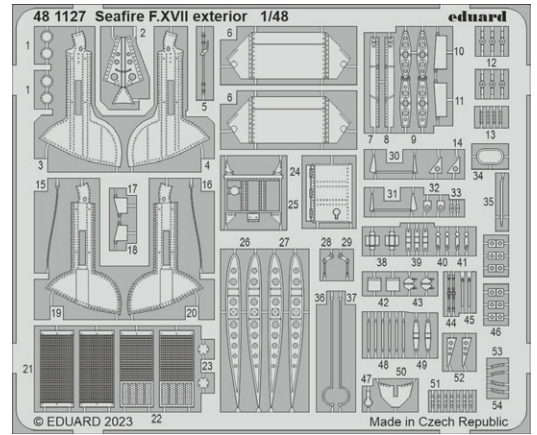

491399 Seafire F.XVII
1/48 Airfix

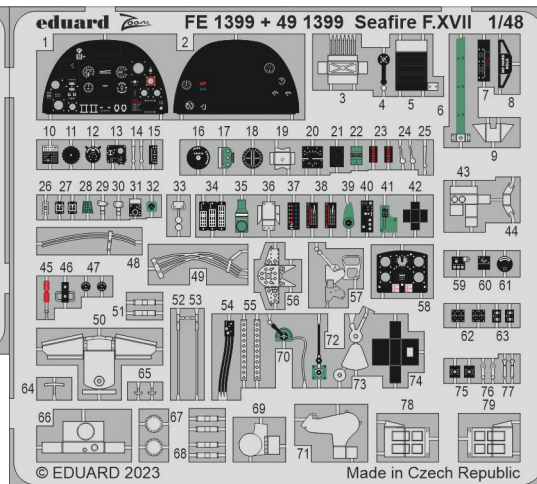
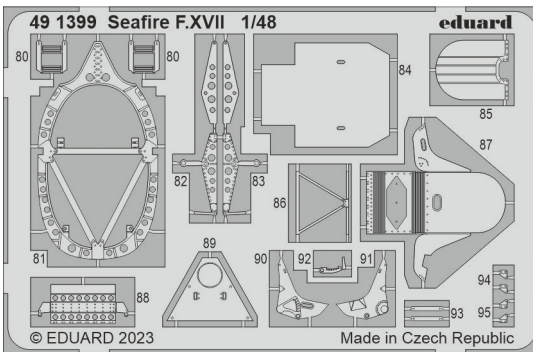

491402 Mi-17 cargo seatbelts STEEL
1/48 Trumpeter

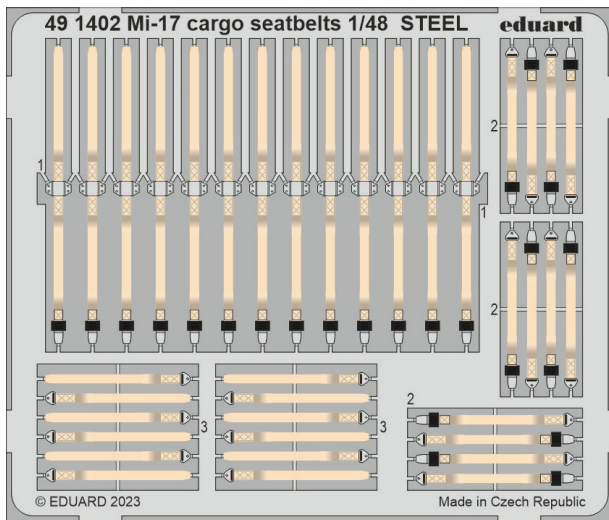

491404 Sea King HAS.1 cargo interior
1/48 Airfix

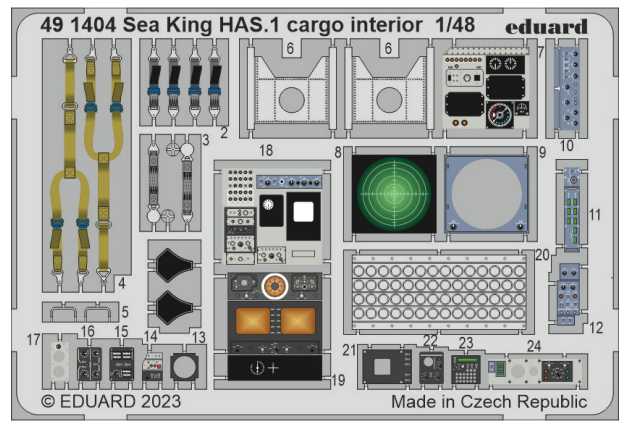

491405 Sea King HAS.5 cargo interior
1/48 Airfix

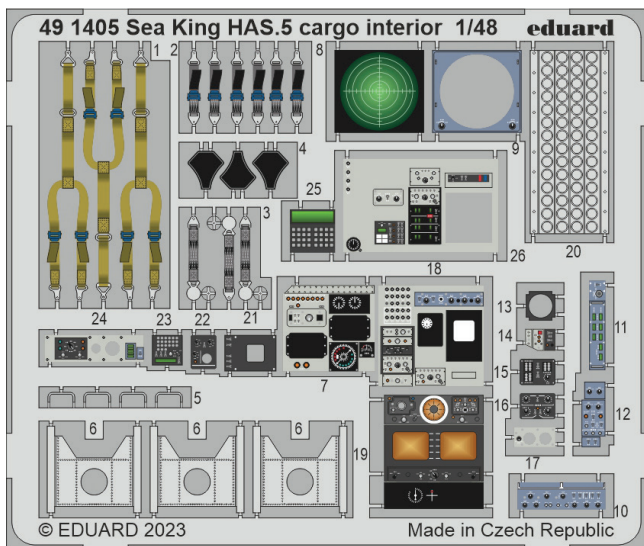

491406 Sea King HU.5 cargo interior
1/48 Airfix

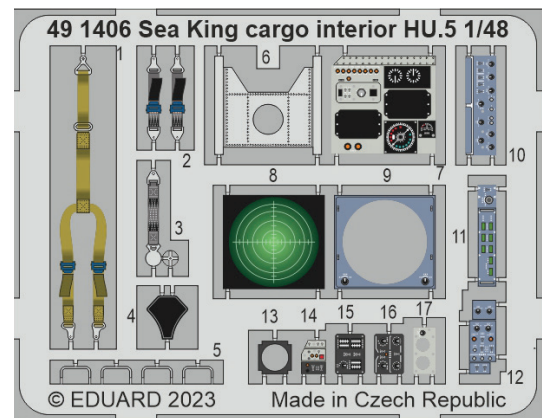

33362 AH-1G early seatbelts STEEL
1/35 ICM

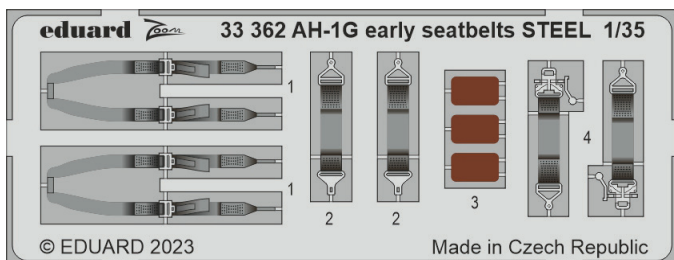

FE1399 Seafire F.XVII
1/48 Airfix

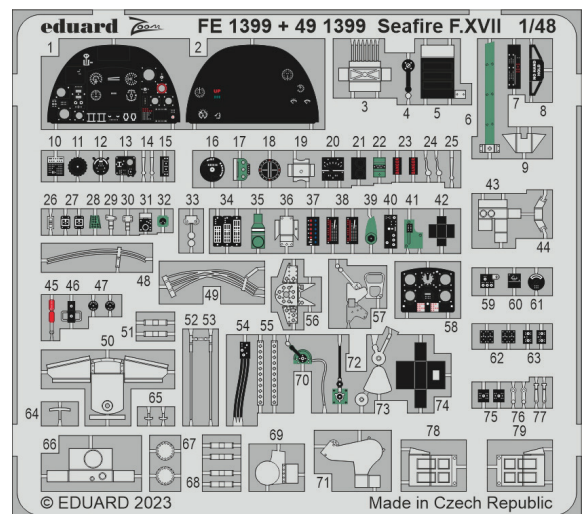

FE1400 Seafire F.XVII seatbelts STEEL
1/48 Airfix

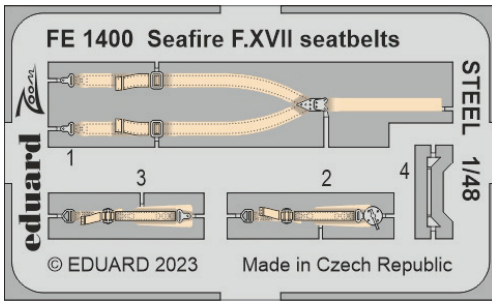

FE1402 Mi-17 seatbelts STEEL
1/48 Trumpeter

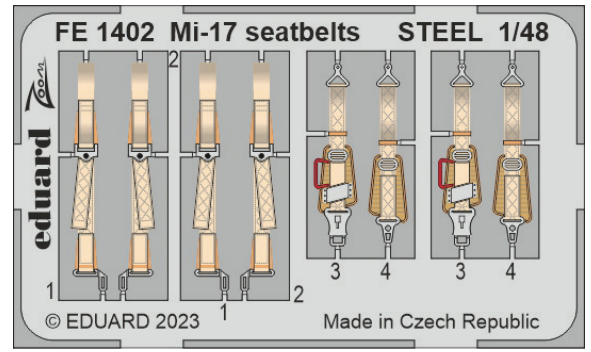

FE1403 Bf 109E-4 Weekend
1/48 Eduard

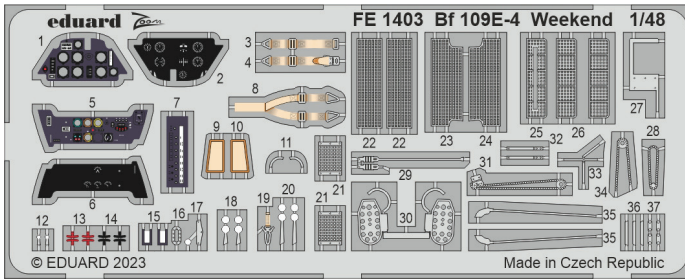

SS815 S-199 Erla canopy Weekend
1/72 Eduard

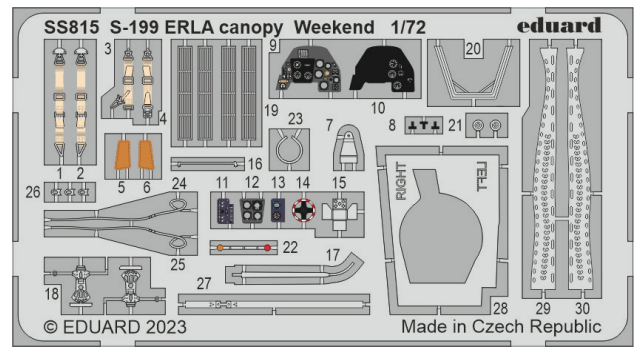

3DL48147 Seafire F.XVII SPACE
1/48 Airfix

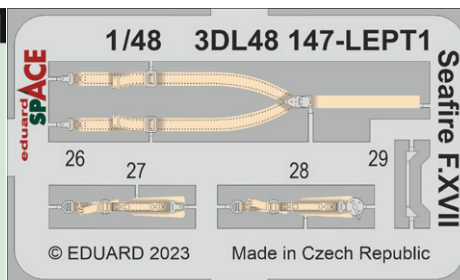
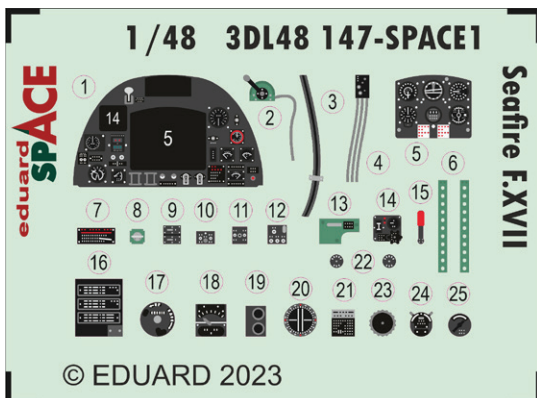

644230 F-16D Block 50 LööK 1/48 Kinetic

LööK set - Brassin pre-painted dashboards and STEEL seatbelts for F-16D in 1/48 scale. Easy to assemble, replaces plastic parts. Recommended kit: Kinetic

Set contains:

- resin: 6 parts
- decals: no
- photo-etched details: yes, pre-painted
- painting mask: no

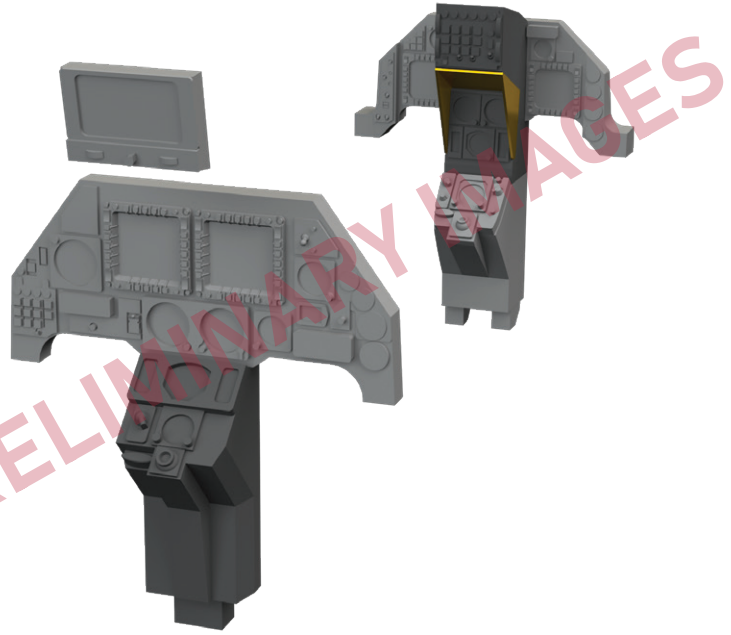

644240 Fw 190A-7 LööK 1/48 Eduard

LööK set - Brassin pre-painted dashboards and STEEL seatbelts for Fw 190A-7 in 1/48 scale. Easy to assemble, replaces plastic parts. Recommended kit: Eduard

Set contains:

- resin: 2 parts
- decals: no
- photo-etched details: yes, pre-painted
- painting mask: no



644241 FM-1 LööK 1/48 Eduard

LööK set - Brassin pre-painted dashboard and STEEL seatbelts for FM-1 in 1/48 scale. Easy to assemble, replaces plastic parts. Recommended kit: Eduard

Set contains:

- resin: 1 part
- 3D print: 1 part
- decals: no
- photo-etched details: yes, pre-painted
- painting mask: no



648906 Bf 109K external fuel tanks 1/48 Eduard

Brassin set - external fuel tanks (3 types) with racks for Bf 109K in 1/48 scale. Easy to assemble, replaces plastic parts. Recommended kit: Eduard

Set contains:

- resin: 3 parts,
- 3D print: 3 parts,
- decals: yes,
- photo-etched details: no,
- painting mask: no.

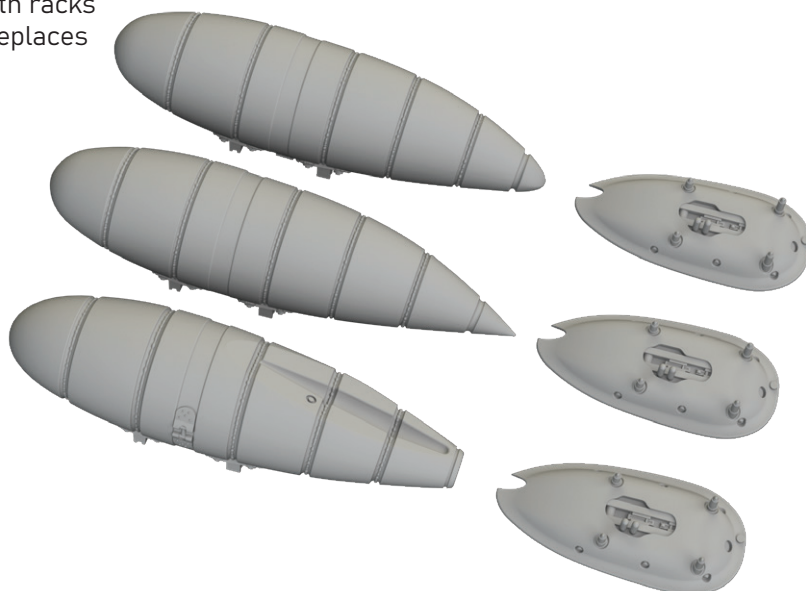

648938 Hurricane Mk.II gun bays PRINT 1/48 Arma Hobby

Brassin set - gun bays for Hurricane Mk.II in 1/48 scale. The set consists of gun bays for both wings. Made by direct 3D printing. Recommended kit: Arma Hobby

Set contains:

- 3D print: 22 parts
- decals: no
- photo-etched details: yes
- painting mask: no

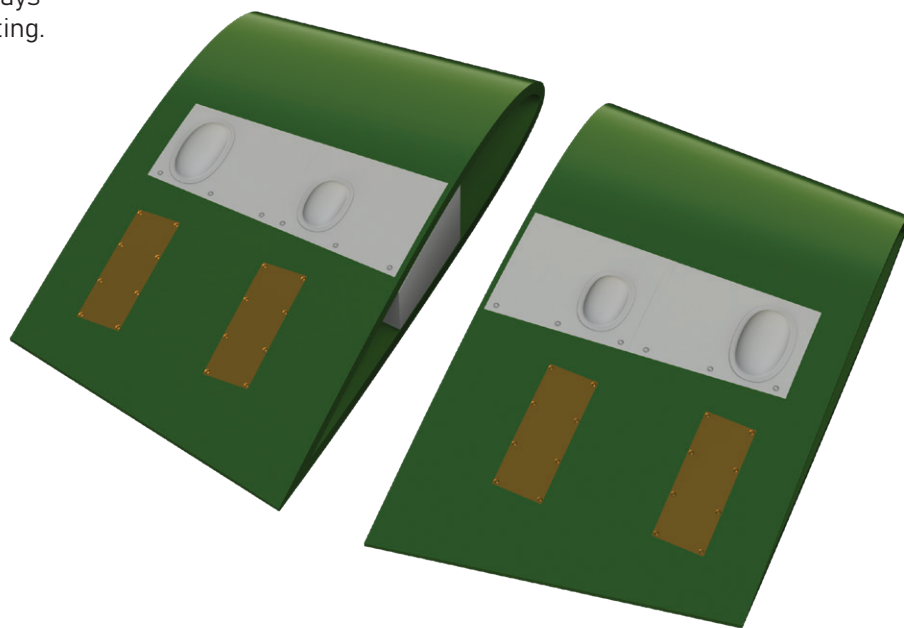

648940 Fw 190A-7 cockpit PRINT 1/48 Eduard

Brassin set - cockpit for Fw 190A-7 in 1/48 scale. Made by direct 3D printing. Recommended kit: Eduard

Set contains:

- 3D print: 19 parts
- decals: yes
- photo-etched details: yes, pre-painted
- painting mask: no

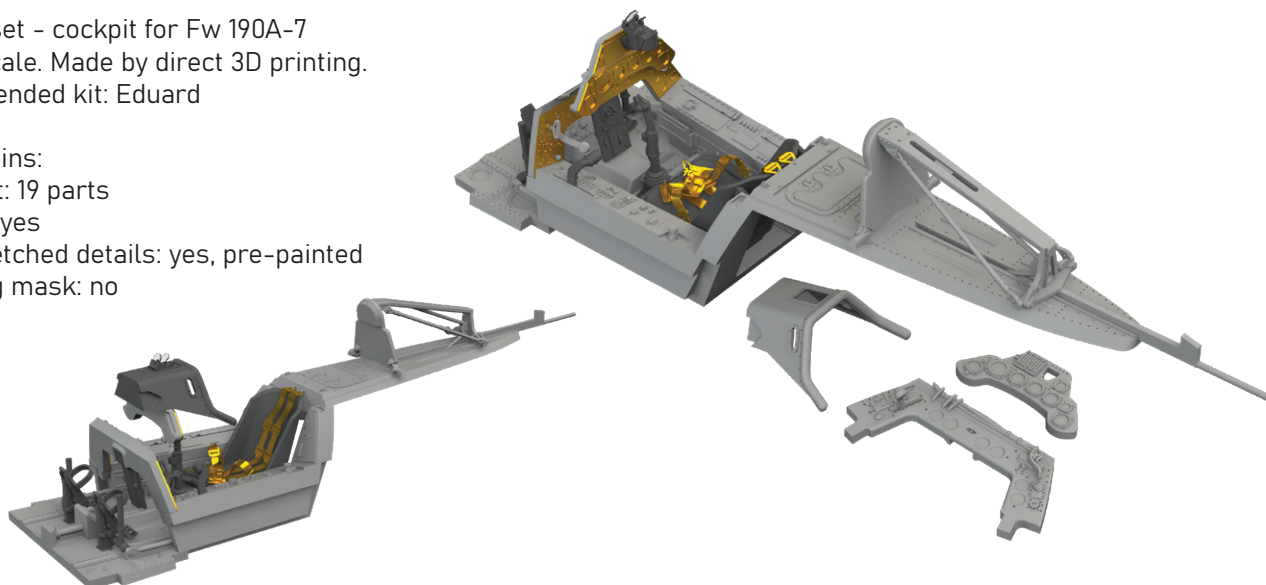

648941 Fw 190A-7 engine & fuselage guns 1/48 Eduard

Brassin set - the engine and fuselage guns installation for Fw 190A-7 in 1/48 scale.
Recommended kit: Eduard

Set contains:

- resin: 31 parts
- decals: no
- photo-etched details: yes
- painting mask: no

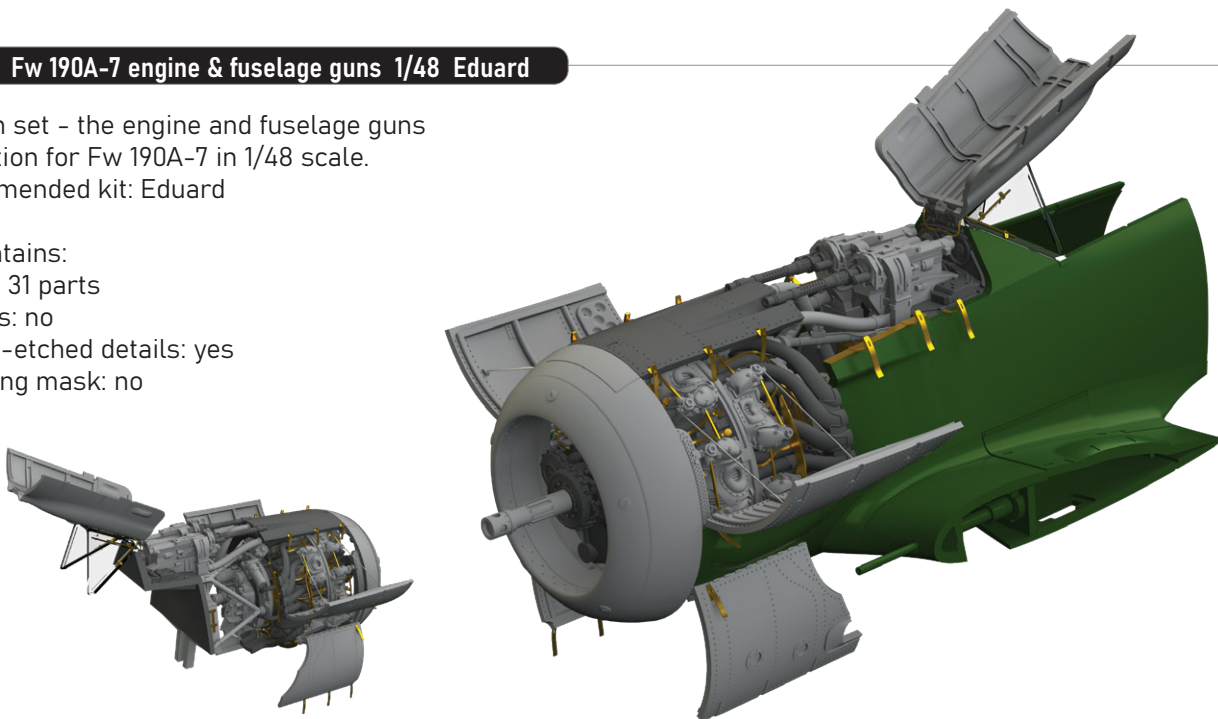

648942 Fw 190A-7 undercarriage legs BRONZE 1/48 Eduard

Brassin set - the undercarriage legs for Fw 190A-7 in 1/48 scale. The legs are made of bronze.
Recommended kit: Eduard

Set contains:

- resin: 2 parts
- bronze: 2 parts
- decals: no
- photo-etched details: no
- painting mask: no

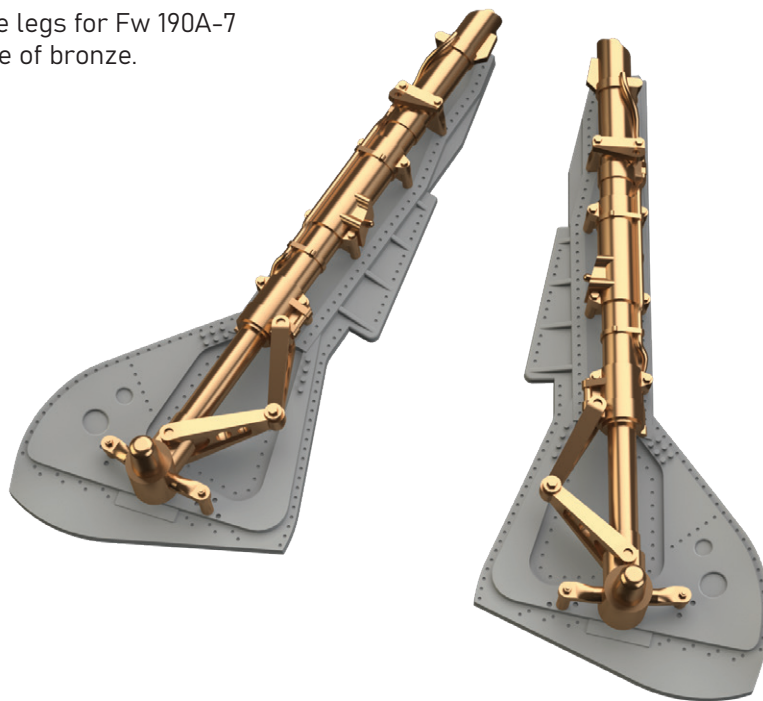

648943 FM-1 undercarriage legs BRONZE 1/48 Eduard

Brassin set - the undercarriage legs for FM-1 in 1/48 scale. The legs are made of bronze.
Recommended kit: Eduard

Set contains:

- 3D print: 4 parts
- bronze: 2 parts
- decals: no
- photo-etched details: no
- painting mask: no



648944 FM-1 wheels 1/48 Eduard

Brassin set - the undercarriage wheels for FM-1 in 1/48 scale. The set consists of the main wheels and a tail wheels. Easy to assemble, replaces plastic parts. Recommended kit: Eduard

Set contains:

- resin: 5 parts
- 3D print: 2 parts
- decals: no
- photo-etched details: yes
- painting mask: yes

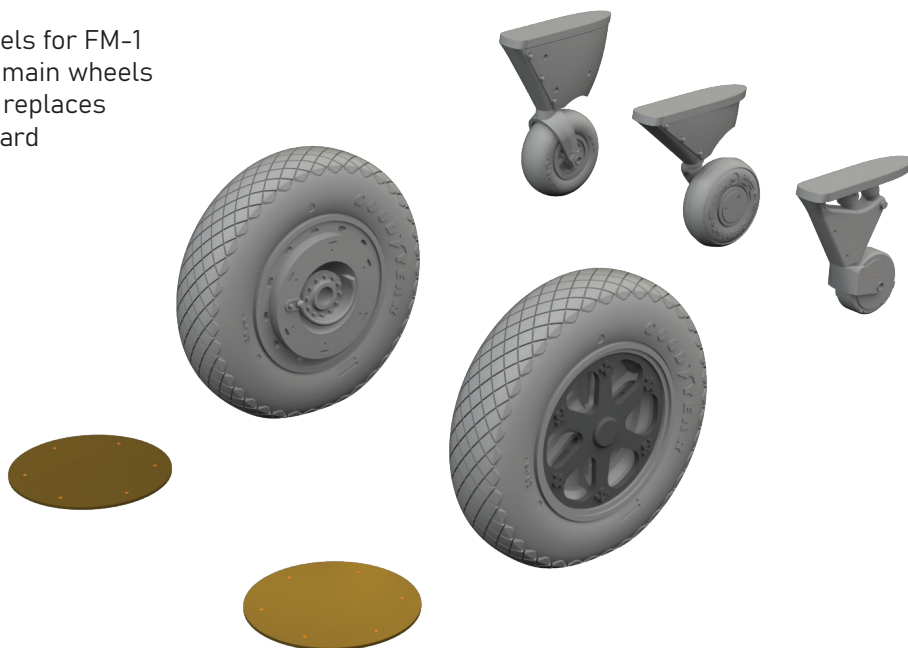

648945 FM-1 folding wings PRINT 1/48 Eduard

Brassin set - folding wings for FM-1 in 1/48 scale. Made by direct 3D printing. Recommended kit: Eduard

Set contains:

- 3D print: 10 parts
- spare plastic wings: 1 set
- decals: no
- photo-etched details: yes
- painting mask: no

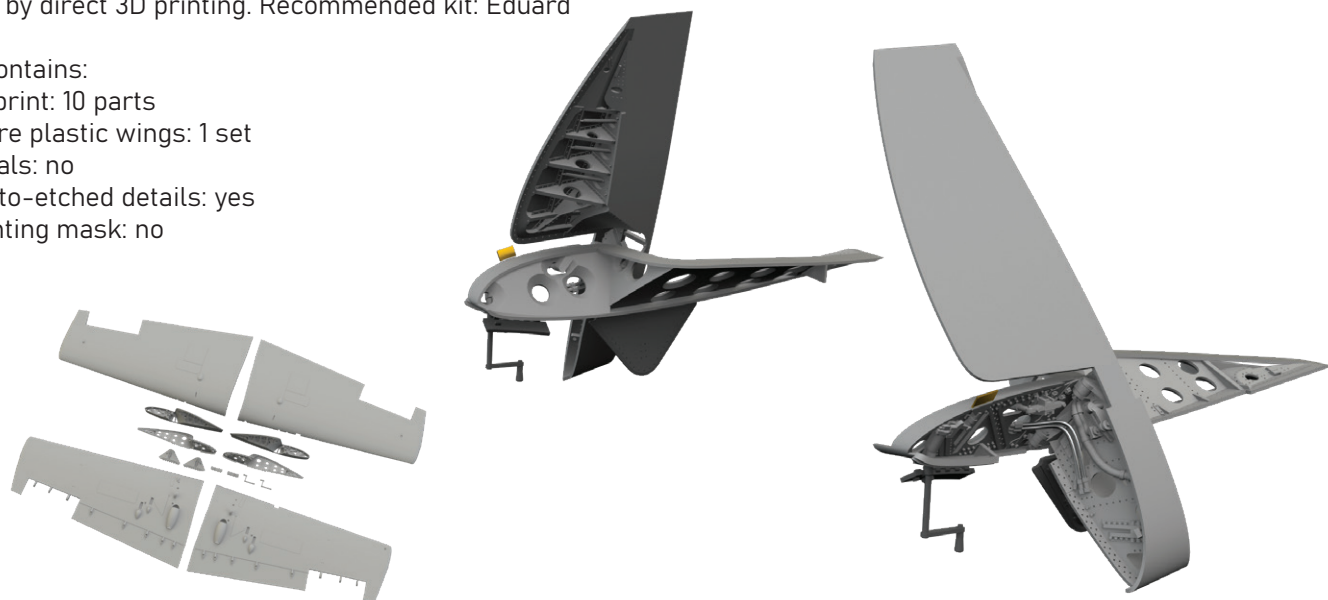

648946 FM-1 exhaust PRINT 1/48 Eduard

Brassin set - exhaust pipes for FM-1 in 1/48 scale. Easy to assemble, replaces plastic parts. Made by direct 3D printing. Recommended kit: Eduard

Set contains:

- 3D print: 2 parts
- decals: no
- photo-etched details: no
- painting mask: no

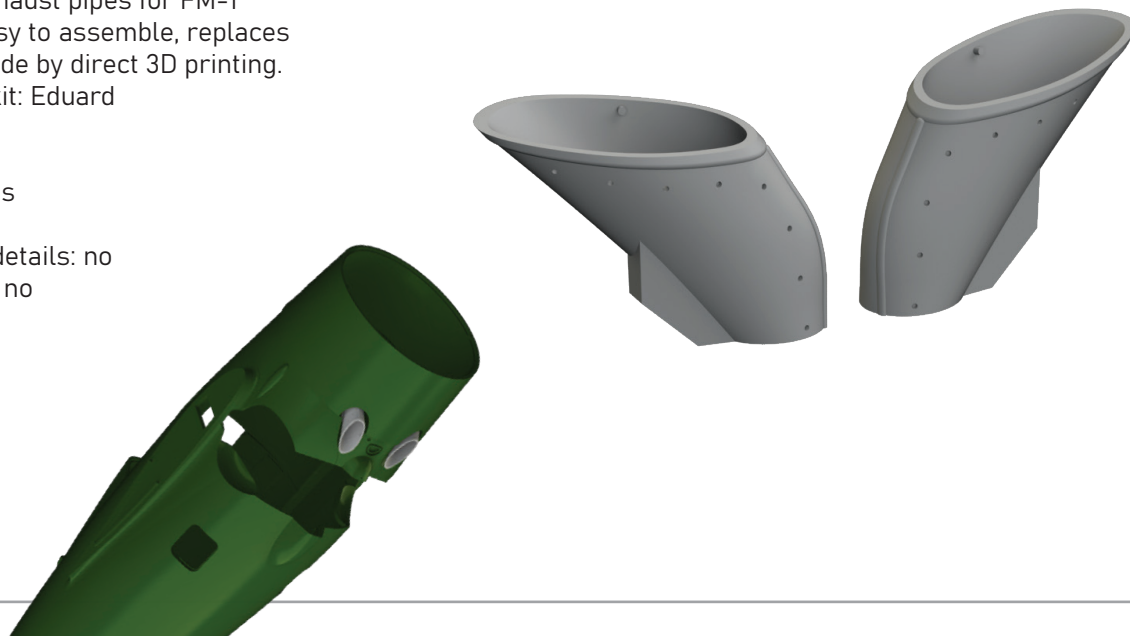

648947 FM-1 engine PRINT 1/48 Eduard

Brassin set - engine for FM-1 in 1/48 scale.
Made by direct 3D printing. Recommended kit: Eduard

Set contains:

- 3D print: 35 parts
- decals: no
- photo-etched details: yes
- painting mask: no

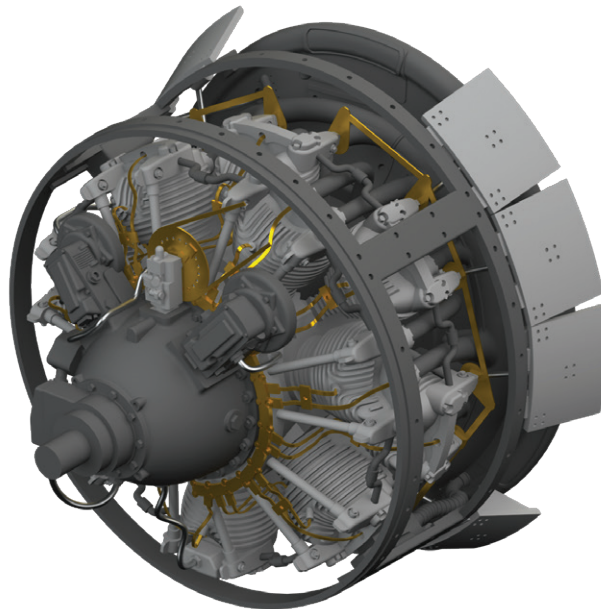
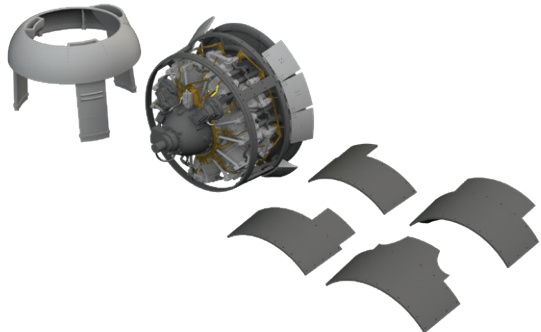

648948 FM-1 wheel bay PRINT 1/48 Eduard

Brassin set - wheel bay for FM-1
in 1/48 scale. Made by direct 3D printing.
Recommended kit: Eduard

Set contains:

- 3D print: 10 parts
- decals: no
- photo-etched details: no
- painting mask: no

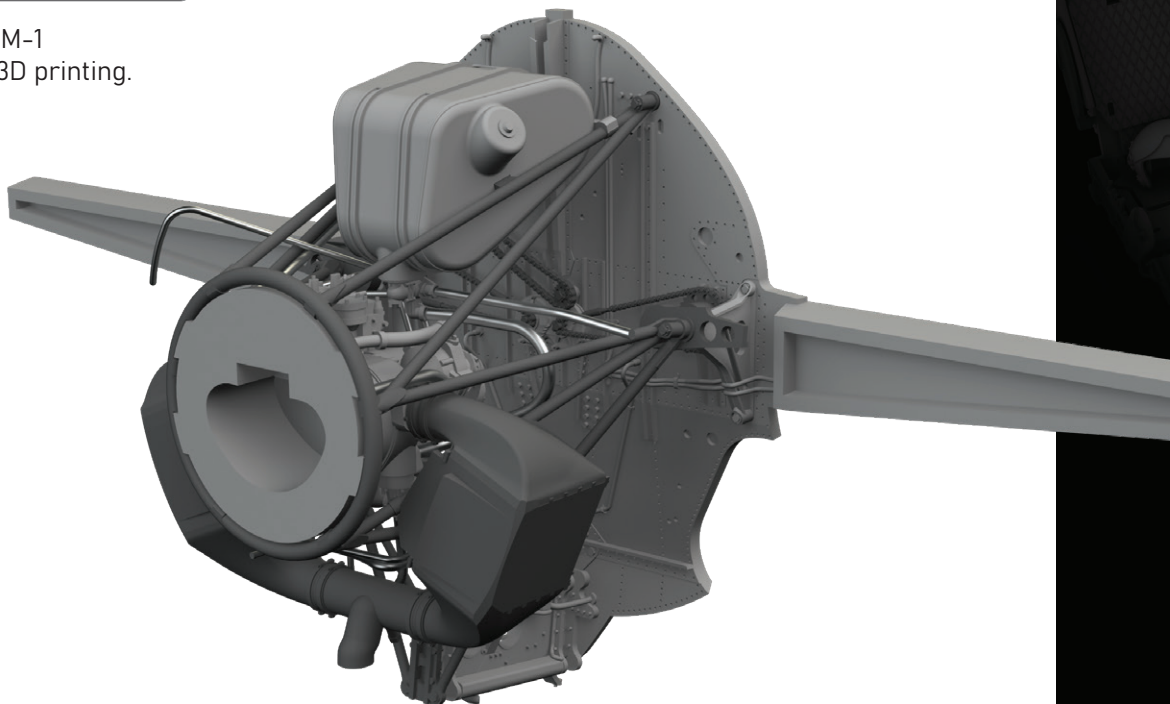

648949 FM-1 seat PRINT 1/48 Eduard

Brassin set - pilot seat for FM-1 in 1/48 scale.
Easy to assemble, replaces plastic parts.
Made by direct 3D printing. Recommended kit: Eduard

Set contains:

- 3D print: 1 part
- decals: no
- photo-etched details: yes, pre-painted
- painting mask: no

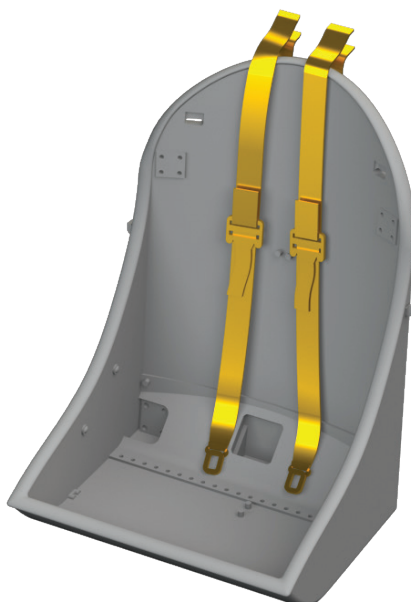

648950 FM-1 gun barrels PRINT 1/48 Eduard

Brassin set - gun barrels for FM-1 in 1/48 scale.
Easy to assemble, replaces plastic parts.
Made by direct 3D printing. Recommended kit: Eduard

Set contains:

- 3D print: 4 parts
- decals: no
- photo-etched details: no
- painting mask: no

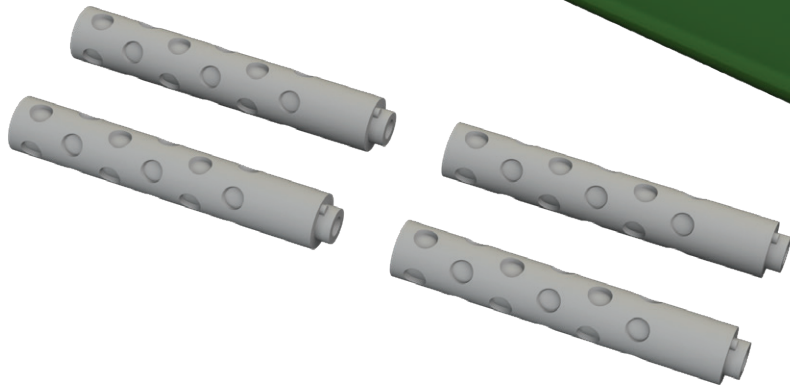

672341 Bf 109G-2/G-4 wheels for bulged wings PRINT 1/72 Eduard

Brassin set - the undercarriage wheels for Bf 109G-2 & G-4 in 1/72 scale. The set consists of the main wheels and a tail wheel.
Easy to assemble, replaces plastic parts.
Recommended kit: Eduard

Set contains:

- resin: 3 parts
- decals: no
- photo-etched details: no
- painting mask: yes

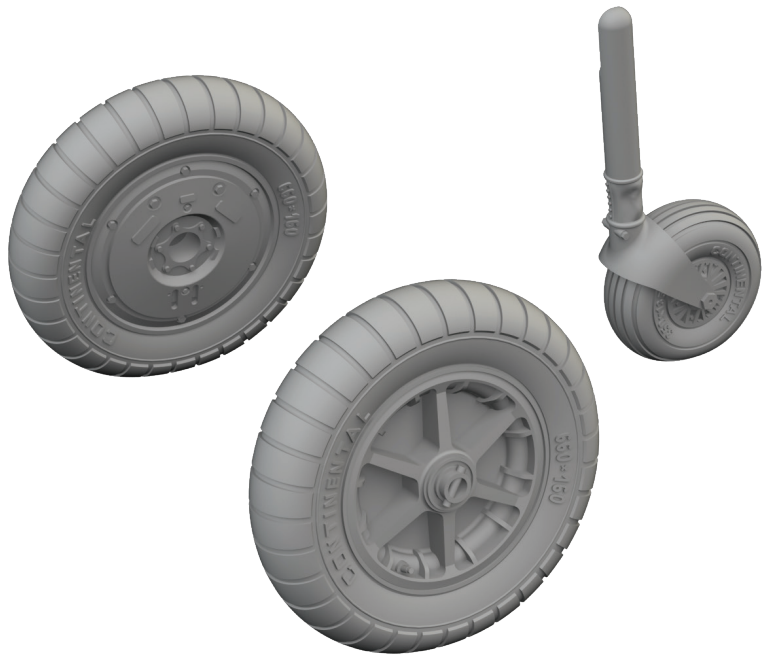

672342 Bf 109G-2 cockpit PRINT 1/72 Eduard

Brassin set - cockpit for Bf 109G-2 in 1/72 scale. Made by direct 3D printing.
Recommended kit: Eduard

Set contains:

- 3D print: 9 parts
- decals: yes
- photo-etched details: yes, pre-painted
- painting mask: no

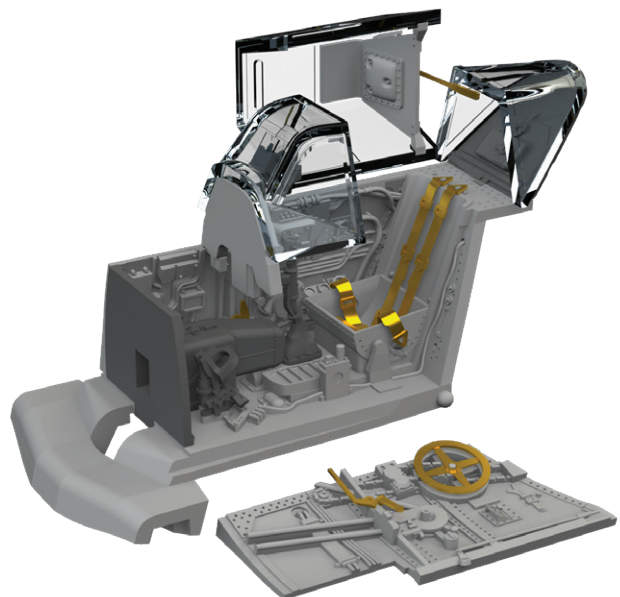

672343 Bf 109G-4 cockpit PRINT 1/72 Eduard

Brassin set - cockpit for Bf 109G-4 in 1/72 scale.
Made by direct 3D printing. Recommended kit: Eduard

Set contains:

- 3D print: 9 parts
- decals: yes
- photo-etched details: yes, pre-painted
- painting mask: no

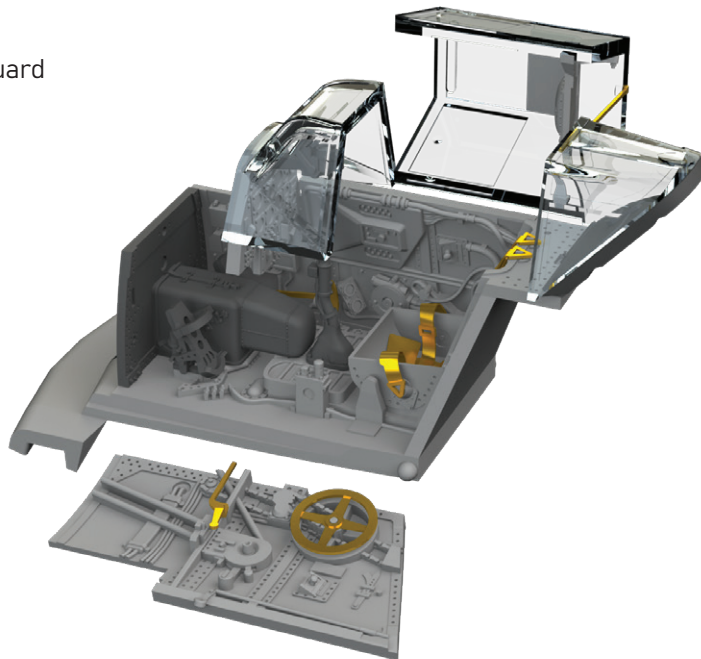
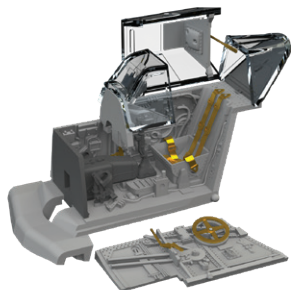

672344 Bf 109G radio compartment PRINT 1/72 Eduard

Brassin set - radio compartment for Bf 109G in 1/72 scale. Made by direct 3D printing. Recommended kit: Eduard

Set contains:

- 3D print: 5 parts
- decals: no
- photo-etched details: yes
- painting mask: no

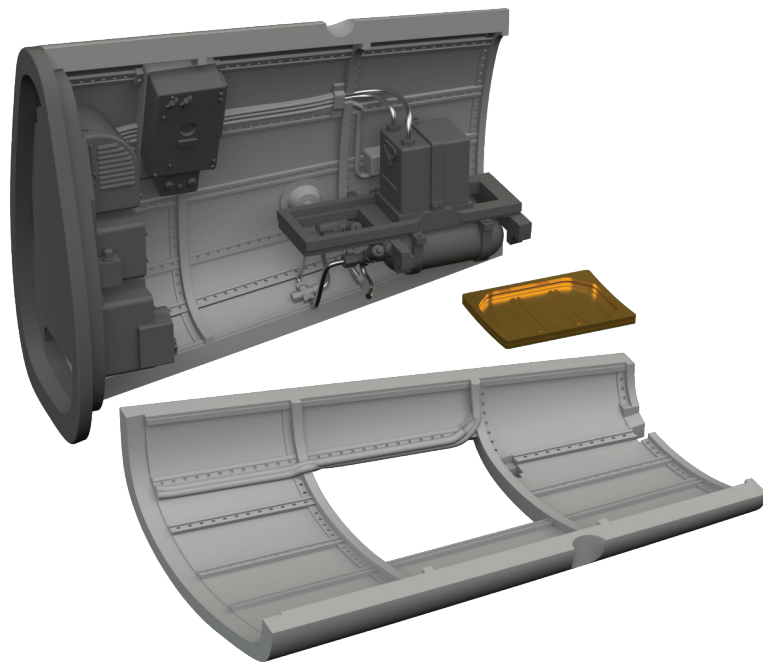
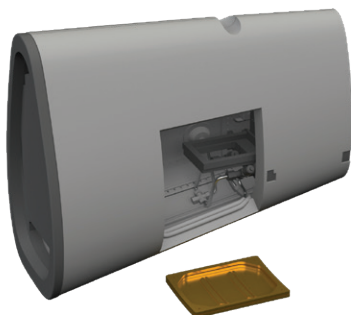

672345 F6F wheel bays PRINT 1/72 Eduard

Brassin set - wheel bays for F6F in 1/72 scale.
Made by direct 3D printing. Recommended kit: Eduard

Set contains:

- 3D print: 4 parts
- decals: no
- photo-etched details: no
- painting mask: no

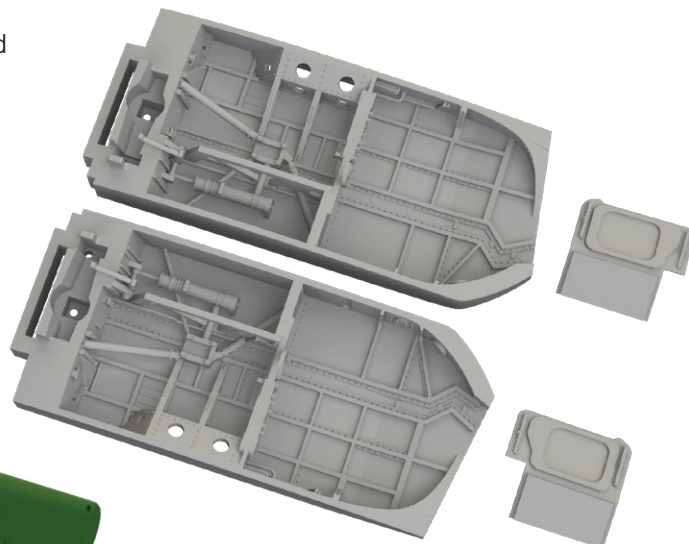
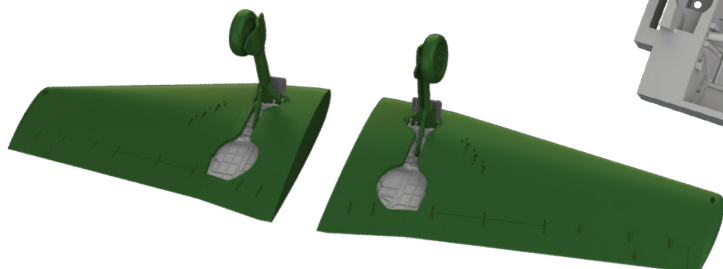

672346 Bf 109G propeller PRINT 1/72 Eduard

Brassin set - propeller for Bf 109G in 1/72 scale. The spinner could be removed. Easy to assemble, replaces plastic parts. Made by direct 3D printing. Recommended kit: Eduard

Set contains:

- 3D print: 2 parts
- resin: 4 parts
- decals: no
- photo-etched details: no
- painting mask: no

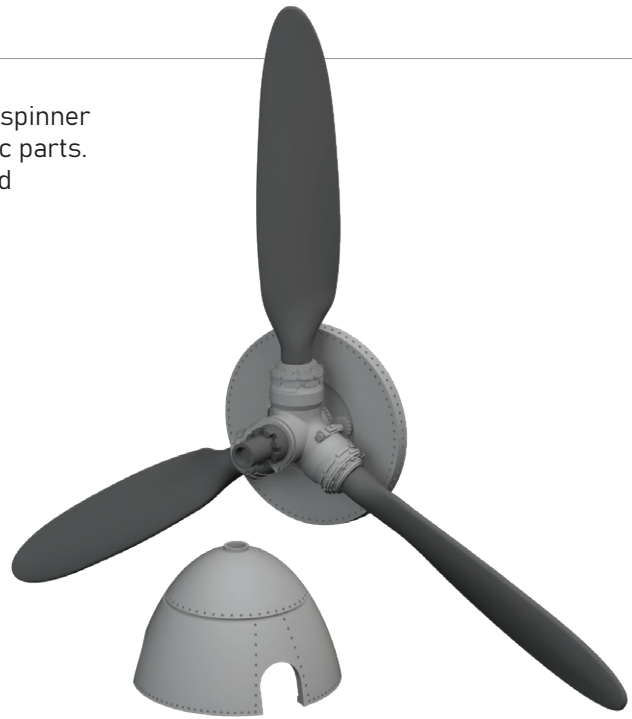
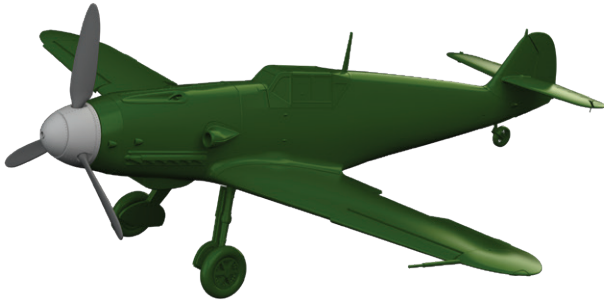

634045 MC.202 LööKplus 1/32 Italeri

Collection of 3 sets for MC.202 in 1/32 scale. Recommended kit: Italeri

- LööK set (pre-painted Brassin dashboard & Steelbelts)
- TFace painting mask
- undercarriage wheels

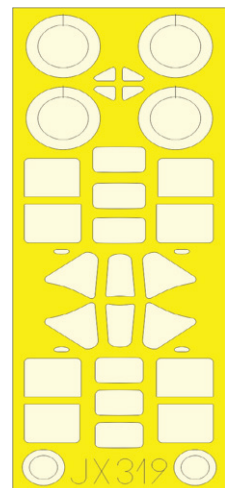
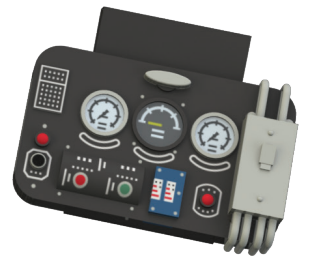
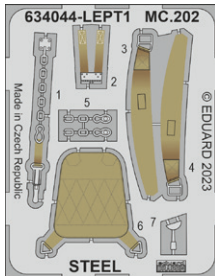

644236 MiG-17F LööKplus 1/48 AMMO

Collection of 3 sets for MIG-17F in 1/48 scale.
Recommended kit: AMMO

- LööK set (pre-painted Brassin dashboard & Steelbelts)
- TFace painting mask
- undercarriage wheels

LööK

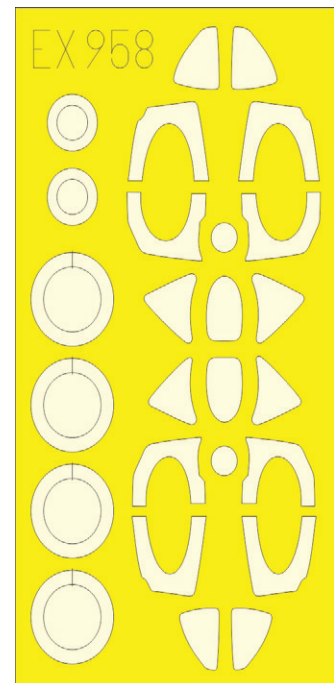
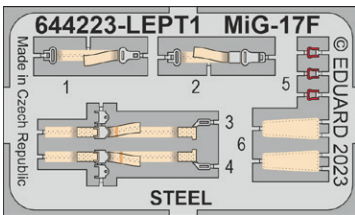

644237 F-16D Block 30 LööKplus 1/48 Kinetic

Collection of 3 sets for F-16D Block 30 in 1/48 scale.
Recommended kit: Kinetic

- LööK set (pre-painted Brassin dashboards & Steelbelts)
- TFace painting mask
- ejection seats

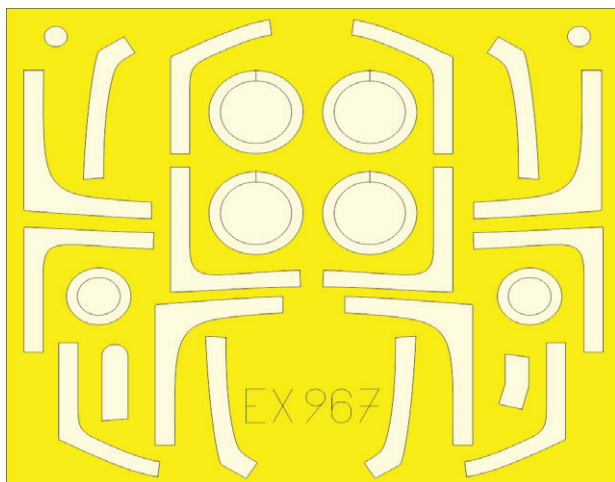
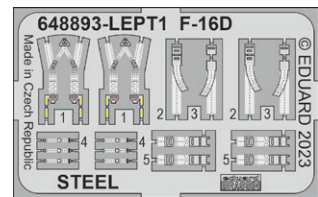
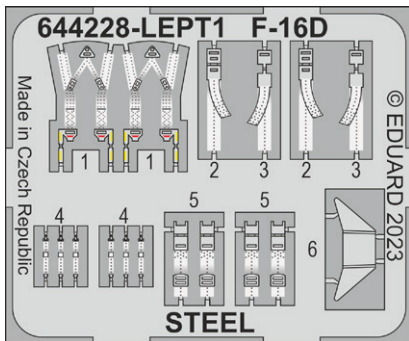
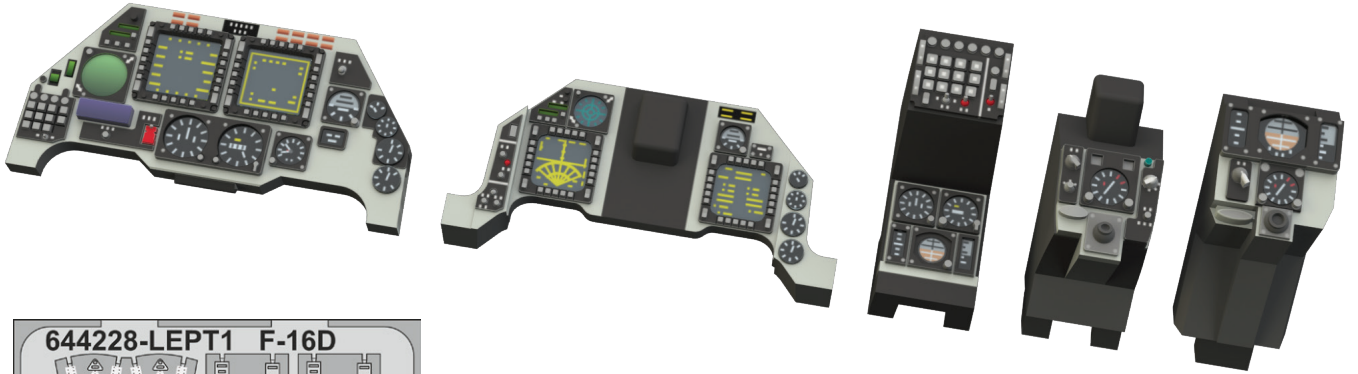

SIN648115 FM-2 w/ armoured headrest ESSENTIAL 1/48 Eduard

Collection of 4 sets for FM-2 in 1/48 scale.
Recommended kit: Eduard

- cockpit
- exhausts
- undercarriage legs BRONZE
- undercarriage wheels

All sets included in this BIG SIN are available separately,
but with every BIG SIN set you save up to 30 %.



SIN648117 F6F undercarriage 1/48 Eduard

Collection of 3 sets for F6F-3 and F6F-5 in 1/48 scale.
Recommended kit: Eduard

- undercarriage bays
- undercarriage wheels
- undercarriage legs BRONZE

All sets included in this BIG SIN are available separately,
but with every BIG SIN set you save up to 30 %.



BIG49388 Yak-9T 1/48 Zvezda

- 491376 Yak-9T 1/48
- FE1377 Yak-9T seatbelts STEEL 1/48
- EX974 Yak-9T 1/48

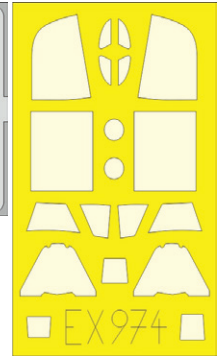
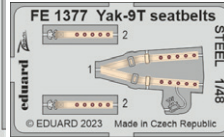
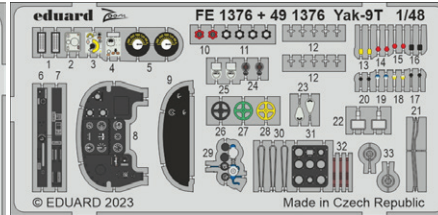
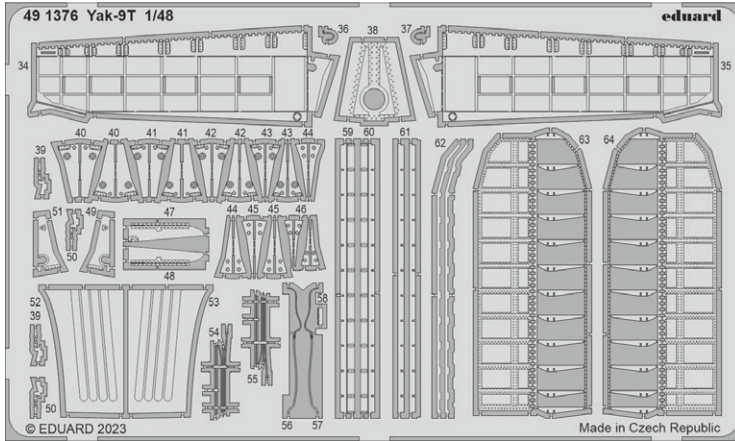

BIG49389 F-4G 1/48 Meng

- 481121 F-4G reinforcement straps & formation lights 1/48
- 49103 Remove Before Flight STEEL
- 491378 F-4G 1/48
- FE1379 F-4G seatbelts STEEL 1/48
- EX972 F-4G 1/48

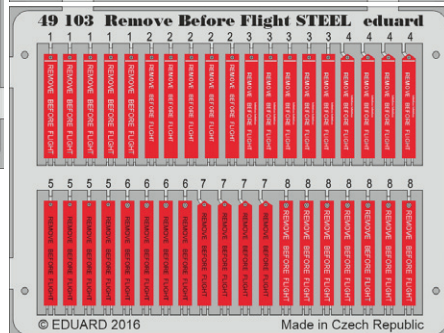
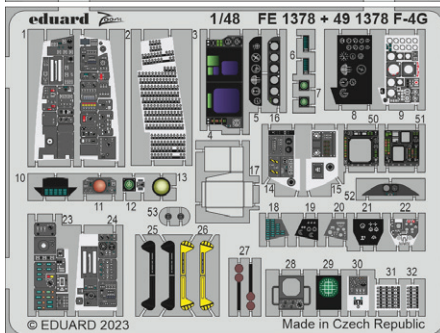
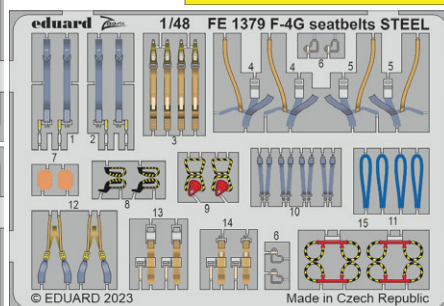
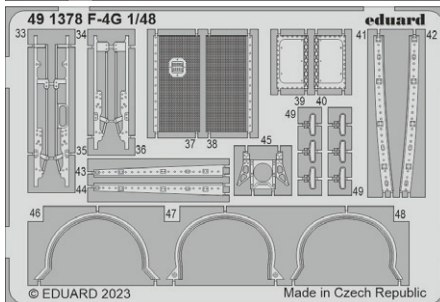
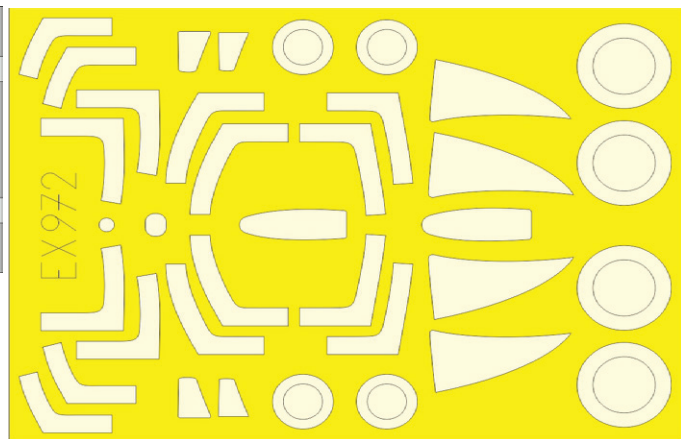
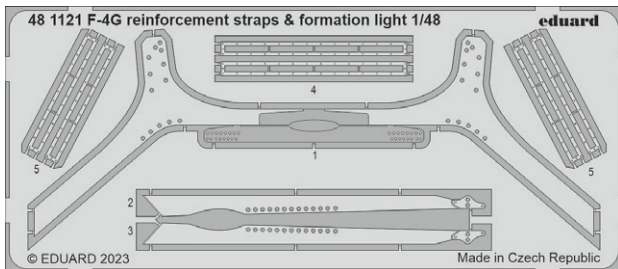

BIG72176 PBY-5A 1/72 Hobby 2000/Academy

- 72731 PBY-5A exterior 1/72
- 73806 PBY-5A 1/72
- CX115 PBY-5 Catalina 1/72

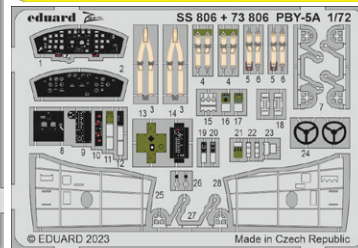
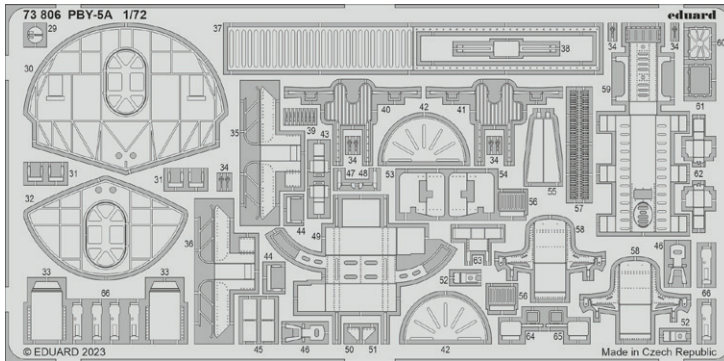
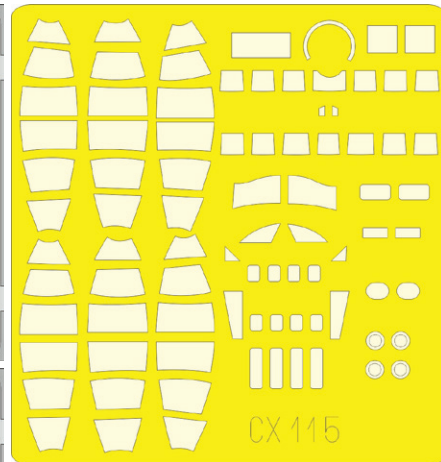
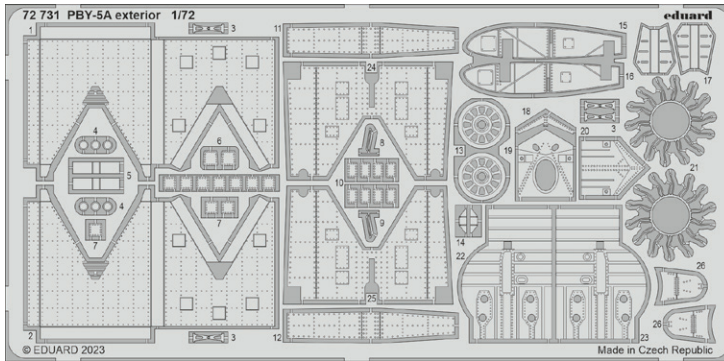

BIG5369 USS Nimitz CVN-68 PART I 1/350 Trumpeter

- 53295 USS Nimitz CVN-68 part 1 1/350
- 53296 USS Nimitz CVN-68 part 2 1/350
- 53297 USS Nimitz CVN-68 part 3 1/350

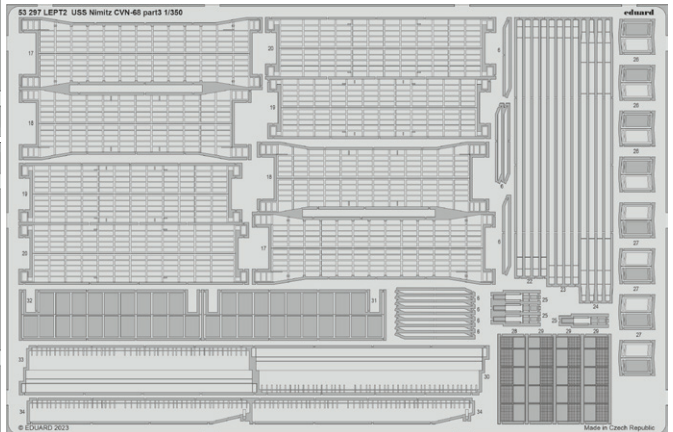
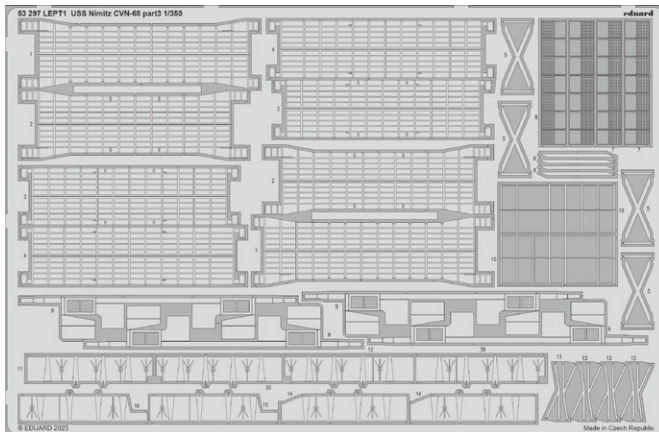
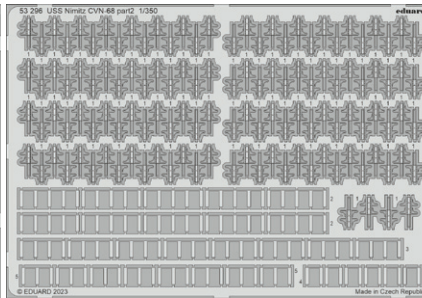
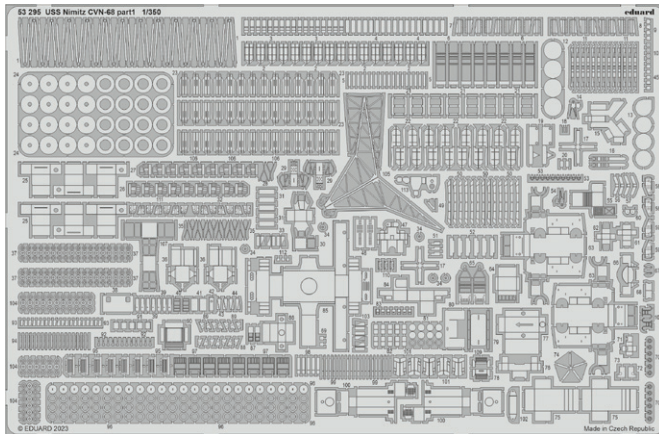



#648904

Bf 109K-4 cockpit **PRINT**

1/48 Eduard

Brassin set - cockpit for Bf 109K-4
in 1/48 scale. Made by direct 3D printing.
Recommended kit: Eduard

Set contains:

- 3D print: 16 parts
- decals: yes
- photo-etched details: yes, pre-painted
- painting mask: no

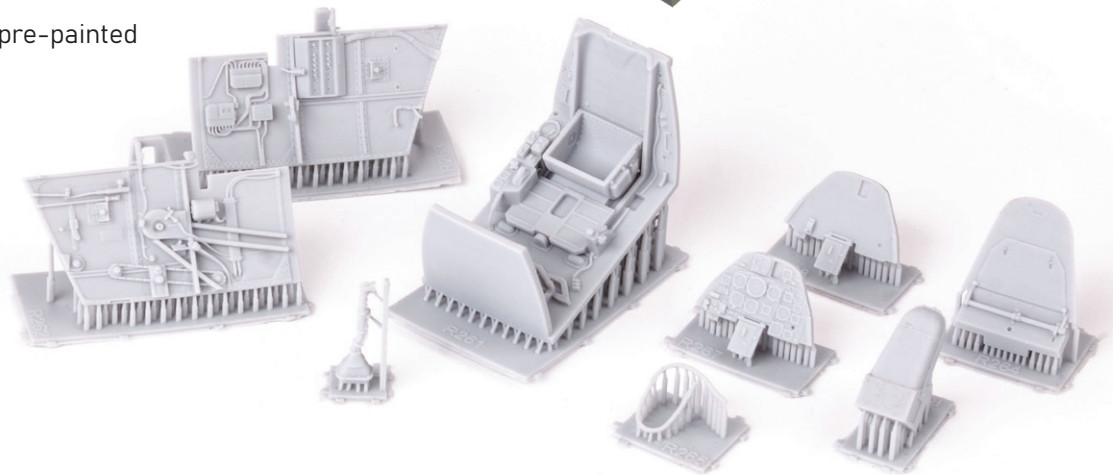
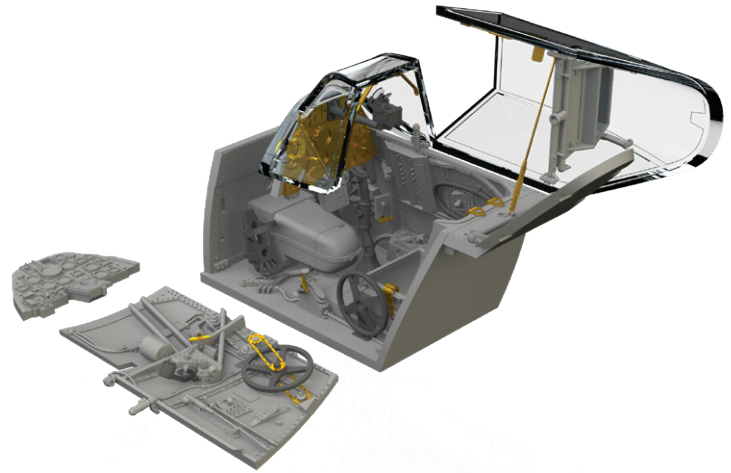

#648905

Bf 109K-4 undercarriage legs **BRONZE**

1/48 Eduard

Brassin set - the undercarriage legs for Bf 109K-4
in 1/48 scale. The legs are made of bronze.
Recommended kit: Eduard

Set contains:

- 3D print: 4 parts
- bronze: 2 parts
- decals: no
- photo-etched details: no
- painting mask: no

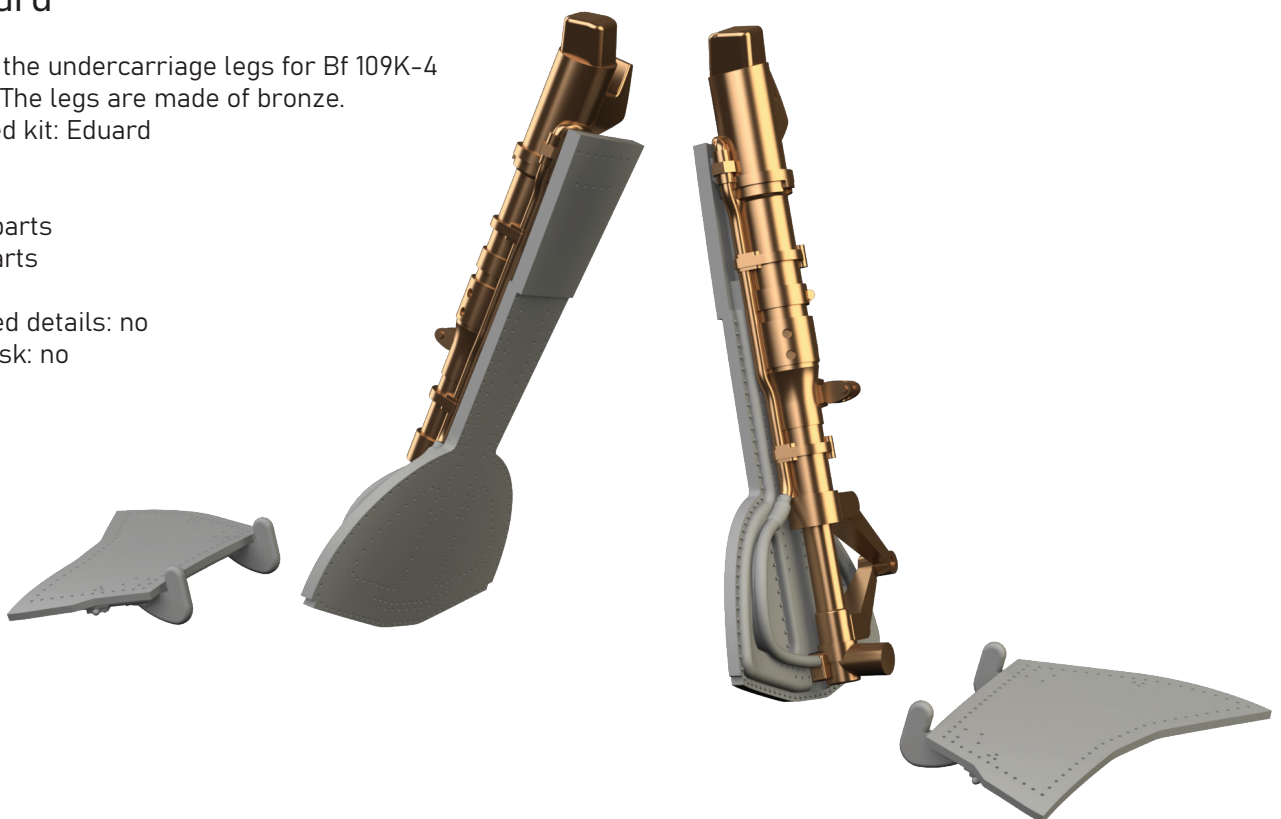

#672333

F-35A wheels

1/72 Tamiya



Brassin set - the undercarriage wheels for F-35A in 1/72 scale. The set consists of the main wheels and a nose wheel. Easy to assemble, replaces plastic parts. Recommended kit: Tamiya

Set contains:

- resin: 3 parts
- decals: no
- photo-etched details: no
- painting mask: yes



#672334

F-35A exhaust nozzle PRINT

1/72 Tamiya

Brassin set - exhaust nozzle for F-35A in 1/72 scale. Made by direct 3D print. Recommended kit: Tamiya

Set contains:

- 3D print: 4 parts
- decals: no
- photo-etched details: no
- painting mask: no



#672335

F-35A cockpit PRINT

1/72 Tamiya

Brassin set - cockpit for F-35A
in 1/72 scale. Made by direct 3D print.
Recommended kit: Tamiya

Set contains:

- 3D print: 7 parts
- decals: yes
- photo-etched details: yes, pre-painted
- painting mask: no

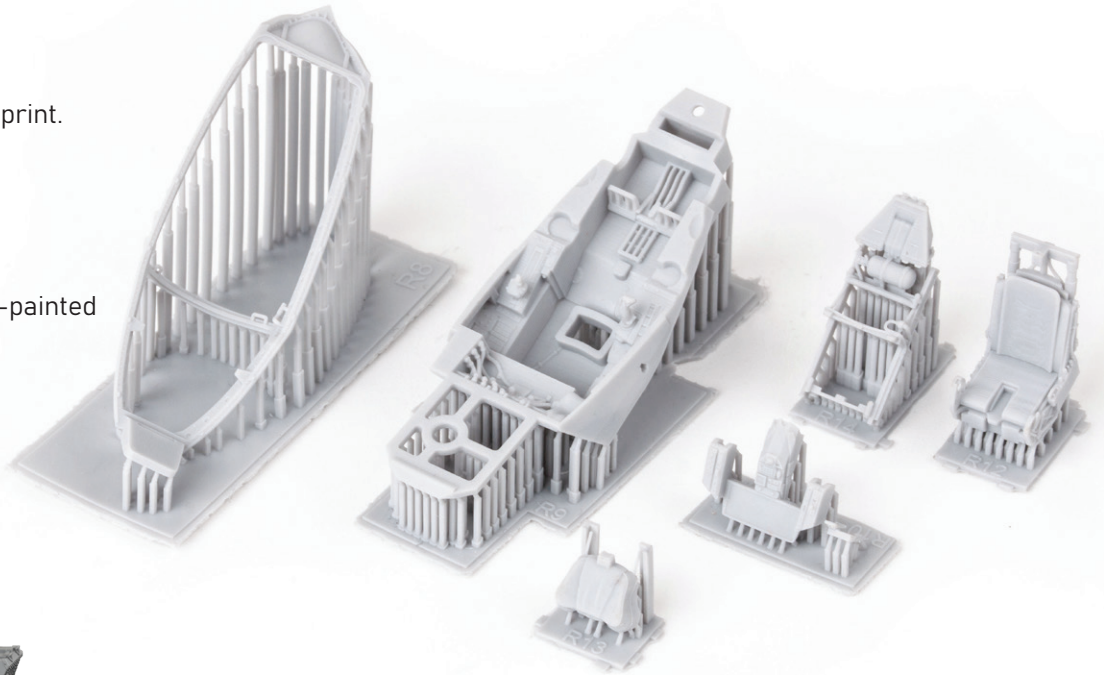

#672336

F-35A ejection seat PRINT

1/72 Tamiya

Brassin set - ejection seat for F-35A
in 1/72 scale. Made by direct 3D printing.
Easy to assemble, replaces plastic parts.
Recommended kit: Tamiya

Set contains:

- 3D print: 3 parts
- decals: yes
- photo-etched details: yes, pre-painted
- painting mask: no



eduard

WILD CARDS 

LIMITED

DUAL COMBO



1:72

2143

WUNDERSCHÖNE NEUE MASCHINEN

- Pt. 2 -

The famous WWII fighter Bf 109G-2 and G-4 in the service with German, Finnish, Italian, Slovak and Romanian units all during WW2.

- * **Premiere of the Eduard new tool kit**
- * **Pre-painted photo etched parts for the finest detail**
- * **Die cut masks for easy painting**
- * **Decals for 14 marking options**
- * **First 1/72 release of Bf 109G-2/G-4 produced from metal injection moulds since late 70's**



Bf 109G-2/R6, Oblt. Heinrich Ehrler, CO of 6./JG 5, Petsamo, Finland, March 1943



Bf 109G-2/Trop, Oblt. Werner Schroer, CO of 8./JG 27, Rhodes, Greece, November 1942



Bf 109G-2, WNr. 10423, Obfw. Kurt Stöber, 7./JG 54, Izocha, the Soviet Union, January 1943



Bf 109G-2, WNr. 13670, Hptm. Hermann Graf, CO of 9./JG 52, Tusov, the Soviet Union, September 1942



Bf 109G-2, Maj. Heinz Bär, CO of 1./JG 77, Comiso, Italy, September 1942



Bf 109G-2/R6, WNr. 13633, Hptm. Wolf-Dieter Huy, CO of 7./JG 77, Tanyet Harun, Egypt, October 1942



Bf 109G-2, Intm. Eino Ilmari Joutilainen, 1/HLeLv 34, Suulajärvi, Finland, April 1944



Bf 109G-4/R6, Obfw. Rainer Pöttgen, 3./JG 27, Fels am Wagram, Austria, October 1943



Bf 109G-4/R6, WNr. 14997, Lt. Erich Hartmann, 7./JG 52, Taman, the Soviet Union, May 1943



Bf 109G-4, WNr. 19347, Rtk. Ján Režňák, 13. (slovakische) JG 52, Anapa, the Soviet Union, April-May 1943



Bf 109G-4/Trop, WNr. 10795, Oblt. Wolfgang Tonne, CO of 3./JG 53, Bizerta, Tunisia, February 1943



Bf 109G-4/R6/Trop, Lt. Franz Schiehs, CO of 8./JG 53, Tindja, Tunis, April 1943



Bf 109G-4/R6, WNr. 19566, Lt. Giuseppe Gianelli, CO of 365a Squadriglia, 15Do Gruppo Autonomo, Sciacca, Sicily, May-July 1943



Bf 109G-4, Lt. Av. Petre Protopopescu, Escadrila 57, Grupul 7, Vânătoare, Kirovograd, the Soviet Union, June 1943

www.eduard.com