

INFORMATION FOR DISTRIBUTORS

AUGUST 2023

Dear friends,
In today's Leaflet you will find the upcoming releases for August 2023.

THE KITS

In August we will release four new kits as new items and one more that was released earlier and not available for some time. I have to say, there will be a lot to choose from in August!

The first novelty is a 1/48 scale kit in the Limited series under the name WILDER CAT. It focuses on the late version of the Wildcat referred to as FM-2. It was built by the Eastern Aircraft Division factory, which was a subsidiary of General Motors. Due to the more powerful engine, it was the most powerful version of the Wildcat, and was also easily recognizable due to the higher vertical tail. Opponents, however, confused this plane with the original Wildcat version, and pilots of the more powerful FM-2s usually gave them some very nasty surprises in dogfights. That's why we call this wilder version of the Wildcat the WILDER CAT. The kit will include decals for nine US Navy and one Royal Navy aircraft. It will be possible to choose from brightly marked machines that have a coat of one, two or three camouflage colors.

Another item scheduled for August in the Limited Edition is a 1/48 scale kit called THE ZIPPER. It is a cover of the American jet fighter F-104C Starfighter by Kinetic. It features brassin parts and a decal sheet focused on units flying in the Vietnam War. These are aircraft that passed with the 479th and 8th TFW. Some will be done in the paint scheme they had in the US before moving to Southeast Asia. The Zippers will have interesting camouflage and markings, one of which belonged to a pilot who became an ace in WWII with P-38 Lightning.

The ProfiPACK edition will include a 1/72 scale kit of the Bf 109F-4 fighter aircraft. This item is based on the plastic parts included in the 2142 Wundeschöne Neue Maschinen kit released in June, but in this case it is only one set of plastic parts for the Bf 109 F-4 version. The ProfiPACK will include decals for six aircraft of famous Luftwaffe pilots. The western battlefield will be represented by "Assi" Hahn and Frank Liesendahl of the Richthofen Geschwader, the boxart will feature a machine piloted by H.-J. Marseille in Africa, and from the eastern front the machines of "Hannes" Trautloft, "Viki" Bauer and Austrian Heinrich Bartels will be on offer.

In Weekend edition there is a 1/48 scale A6M3 Model 32 "Hamp" kit ready for August. Its decal sheet offers the possibility to build a model of one of the four machines from the South Pacific battlefield. These will include one aircraft with longer gun barrels and also a machine that was found on Ballale Island and is currently being restored to airworthy condition in

the USA. The reconstruction of its camouflage and markings has been handled by both our team and external consultants.

We are re-releasing the MiG-21MF kit in 1/72 scale in the ProfiPACK edition.

MASKS

I don't usually mention masks in this editorial, they are one of the standard products that the customer community knows well. I would like to mention the mask for surface details, so called RAM panels for F-35B kit in 1/48 scale by Italeri. It's a very large set with adequate price, similar to the set for F-35A (Tamiya, 1/48) that we released recently. We are also releasing a set of masks with IJN insignia for the 1/48 scale Rufe fighter seaplane model.

BRASSIN

For August there are more sets for new Eduard 1/72 scale Bf 109F kits. These will be bronze landing gear legs, aileron mass balance and exhausts.

We are also releasing a number of accessories for the FM-2 in 1/48 scale. These will of course be wheels, a separate seat, bronze landing gear legs, gun barrels, a folded wing set (again with additional plastic wing moulding) and a cockpit. A LööK set will also be available for the FM-2 in August. A cockpit variant with armour plate behind the pilot's head will follow in September.

In 1/48 scale we are releasing a cockpit for Bf 109F (Eduard) with an early version of the seat. The set with the more usual seat version is among the July items. For this version of the Bf 109 we will also release two variants of the 3D printed landing gear shafts.

For the A-20G (HKM) bomber kit in 1/32 scale, we are releasing a set of wheels and a LööK set.

We are also releasing a wheel set for the F-4E (Meng, 1/48) and MiG-29 (GWH, 1/72) and in the LööK series there are also sets for the MiG-17F (AMMO, 1/48) and Hurricane Mk.I (HBB, 1/48).

For the A6M3 Zero Type 22 and 32 1/48 scale kits by Eduard we have a set for short barrel guns in the wing for August.

In conjunction with the release of the 1/48th scale F-104A/C kit (Kinetic/Eduard), sets with an exhaust nozzle and aerodynamic brakes is available for August. In the BigSin line, for clients who are allowed to do modelling sins at home, sets for the F-35A (Tamiya, 1/48) and an armament set for the F-4E (Meng, 1/48) are planned for the August offering.

In 1/35 scale, radio equipment for SdKfz 251 (Academy) and generic German fire extinguishers are planned for August.

SPACE

The August offer includes a total of seven items in the

Space range. In 1/48 scale, the Space series includes sets for Bf 110G-4 (Eduard), FM-2 (Eduard), F-16D Block 30, 40 and 50 (Kinetic) and A-10C (Academy). In 1/72 scale there is a set for OV-10A kit released by Ukrainian company ICM.

Photo-etched parts

We started with photo etched sets for the A-20G (HKM, 1/32) kit in July. In August we will follow up with details for the main wheel wells and bomb bay. These are fairly large sets for a large model. They mainly contain perforated ribs and stringers, design features that are clearly visible in both the bomb bay and main wheel wells.

For Academy's new 1/48th scale A-10C fighter aircraft kit, we have prepared for August offer the Steelbelts, a zoom set, a large photo etched set and also a set for the position lights, including masks. This kit will be covered further in the Brassin series.

We have also prepared a zoom set and a large etch set for the 1/72 scale OV-10A kit from ICM.

A set of flaps for FM-2 (Eduard, 1/48) will be available in August.

For the 1/48 scale F-16D kits from Kinetic we are releasing sets that respect the manufacturer's editions of the kit, i.e. Block 30, 40 and 50. These are three zoom sets and three large photo etched sets constructed on their basis. There is also a zoom set for all three production blocks, complete with Steelbelts. The plastic kit is missing the skin reinforcements, which is addressed by the another August photo etched set. This will also be usable for kits of other F-16 versions.

The zoom set is also available for the Eduard A6M3 Type 32 kit in 1/48 scale, which we are releasing simultaneously in the Weekend edition.

The first of several sets for the USS Nimitz CVN-68 (Trumpeter, 1/350) aircraft carrier kit is also included in the August offer.

Orders

We would welcome your pre-orders for August items by Friday, June 30, 2023. Thank you!

July items will be ready for shipping on Friday, 16 June.

We are also sending folder with the graphics included in the Leaflet. Many of you are using our Leaflet images for pre-order section of your e-shops and in your newsletters. We hope this will save you some time.

If you would like get more information, clarify some points or if you would need our help, please contact us at [department@](mailto:department@jan.bobek@eduard.cz) or contact me directly at jan.bobek@eduard.cz

Jan Bobek

Product previews are subject of change.

Instruction sheets,
more pictures and information
can be found on www.eduard.com

This leaflet can be downloaded from www.eduard.com

eduard

PLASTIC KITS

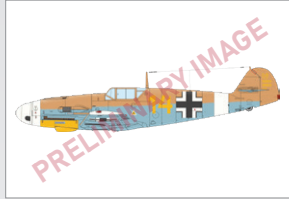

70155 **Bf 109F-4**
1/72 ProfiPACK

DETAIL

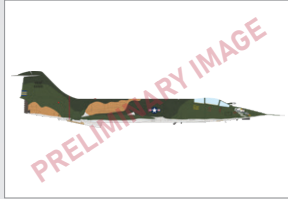

11169 **THE ZIPPER**
1/48 Limited

DETAIL



11175 **WILDER CAT**
1/48 Limited

DETAIL

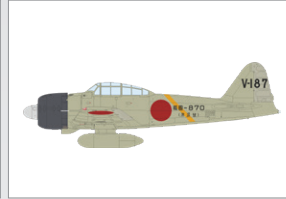

84191 **A6M3 Zero Type 32**
1/48 Weekend edition

DETAIL



70142 **MiG-21MF fighter bomber**
1/72 ProfiPACK **Re-release**

DETAIL

MASKS

EX964	A-10C TFace	1/48	Academy
EX965	FM-2 TFace	1/48	Eduard
EX966	F-16D Block 30/40/50	1/48	Kinetic
EX967	F-16D Block 30/40/50 TFace	1/48	Kinetic
EX968	F-35B RAM coating	1/48	Italeri
EX969	A6M2-N Rufe national insignia	1/48	Eduard
EX970	A6M3 Zero Type 32 Weekend	1/48	Eduard
CX650	OV-10A	1/72	ICM

SPACE

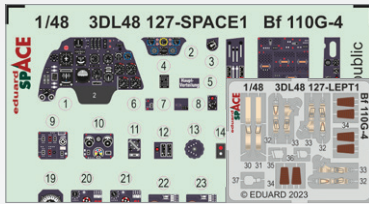

3DL48127 **Bf 110G-4 SPACE**
1/48 Eduard
(2 parts)

DETAIL

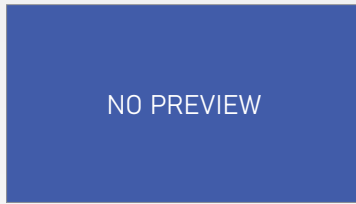

3DL48128 **FM-2 SPACE**
1/48 Eduard
(2 parts)

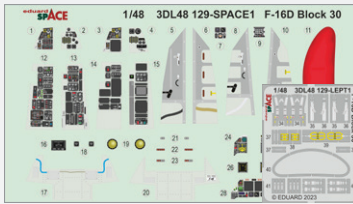

3DL48129 **F-16D Block 30 SPACE**
1/48 Kinetic
(2 parts)

DETAIL

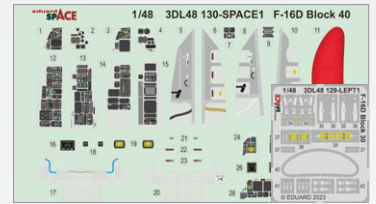

3DL48130 **F-16D Block 40 SPACE**
1/48 Kinetic
(2 parts)

DETAIL

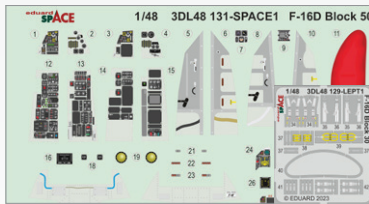

3DL48131 **F-16D Block 50 SPACE**
1/48 Kinetic
(2 parts)

DETAIL

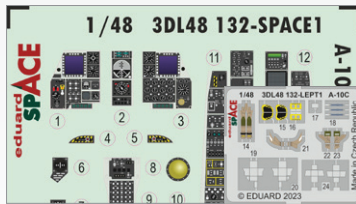

3DL48132 **A-10C SPACE**
1/48 Academy
(2 parts)

DETAIL

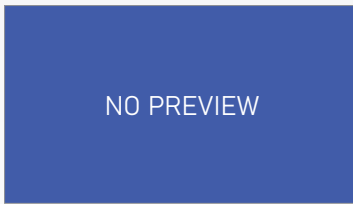

3DL72020 **OV-10A SPACE**
1/72 ICM
(2 parts)

DETAIL

PHOTO-ETCHED SETS

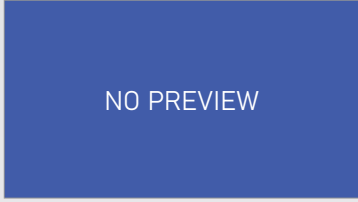

53295 USS Nimitz CVN-68 part 1
1/350 Trumpeter
(1 part)

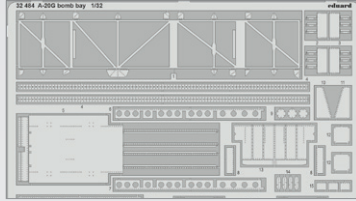

32484 A-20G bomb bay
1/32 HKM
(1 part)

[DETAIL](#)

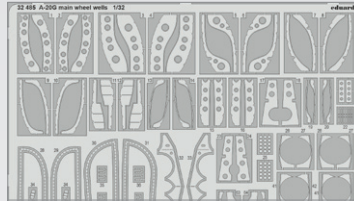

32485 A-20G main wheel wells
1/32 HKM
(1 part)

[DETAIL](#)

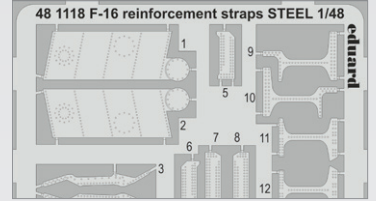

481118 F-16 reinforcement straps
STEEL 1/48 Kinetic
(1 part)

[DETAIL](#)

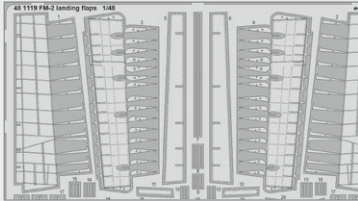

481119 FM-2 landing flaps
1/48 Eduard
(1 part)

[DETAIL](#)

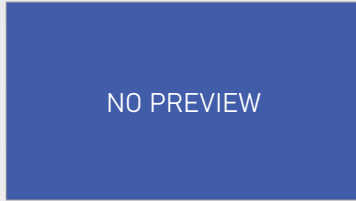

481120 A-10C formation lights
1/48 Academy
(2 parts)

[DETAIL](#)

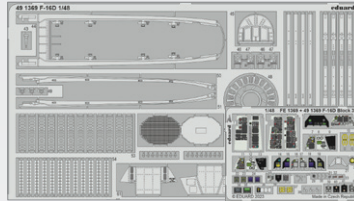

491369 F-16D Block 30
1/48 Kinetic
(2 parts)

[DETAIL](#)

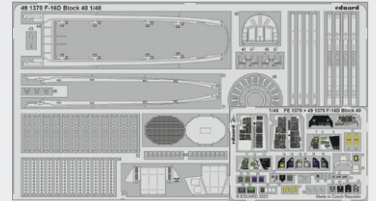

491370 F-16D Block 40
1/48 Kinetic
(2 parts)

[DETAIL](#)

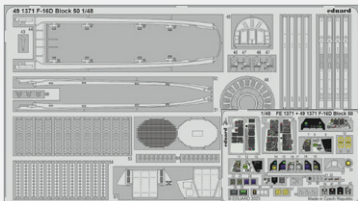

491371 F-16D Block 50
1/48 Kinetic
(2 parts)

[DETAIL](#)

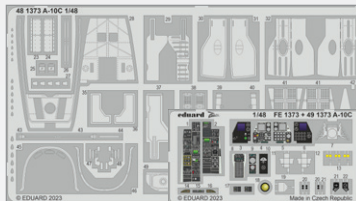

491373 A-10C
1/48 Academy
(2 parts)

[DETAIL](#)

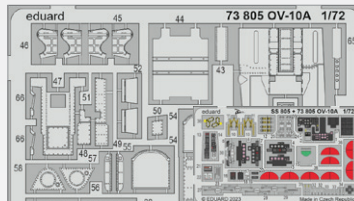

73805 OV-10A
1/72 ICM
(2 parts)

[DETAIL](#)

PHOTO-ETCHED SETS

ZOOM

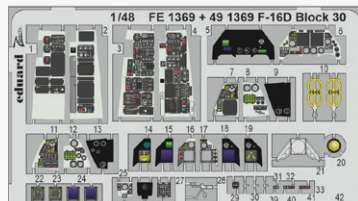

FE1369 F-16D Block 30
1/48 Kinetic
(1 part)

[DETAIL](#)

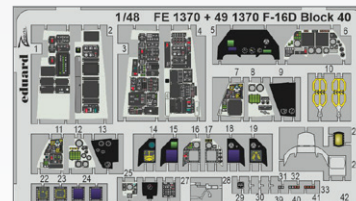

FE1370 F-16D Block 40
1/48 Kinetic
(1 part)

[DETAIL](#)



FE1371 F-16D Block 50
1/48 Kinetic
(1 part)

[DETAIL](#)

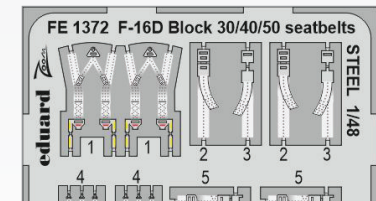

FE1372 F-16D Block 30/40/50
seatbelts STEEL 1/48 Kinetic
(1 part)

[DETAIL](#)



FE1373 A-10C
1/48 Academy
(1 part)

[DETAIL](#)

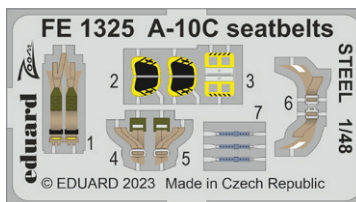

FE1374 A-10C seatbelts STEEL
1/48 Academy
(1 part)

[DETAIL](#)

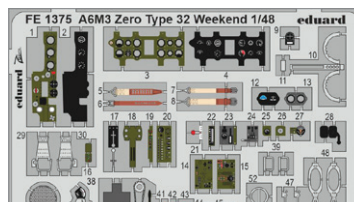

FE1375 A6M3 Zero Type 32
Weekend 1/48 Eduard
(1 part)

[DETAIL](#)

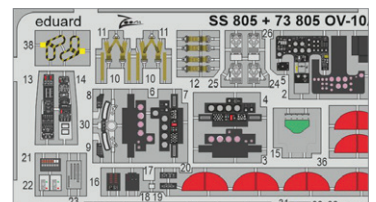

SS805 OV-10A
1/72 ICM
(1 part)

[DETAIL](#)

DECAL

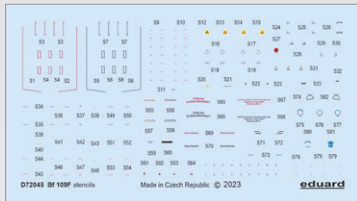

D72045 Bf 109F stencils
1/72 Eduard
(1 part)

DETAIL

EDDIE THE RIVETER

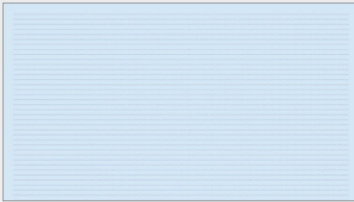

ER32001 Single riveting rows
1/32
(1 part)

DETAIL

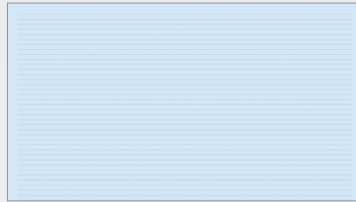

ER48006 Single riveting rows
1/48
(1 part)

DETAIL

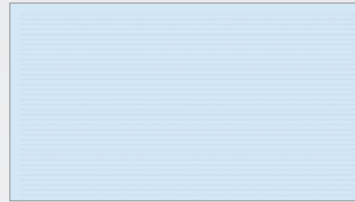

ER72001 Single riveting rows
1/72
(1 part)

DETAIL

BIG ED SETS

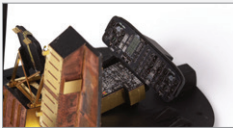

BIG33152 CH-54A
1/35 ICM

DETAIL



BIG49373 B-24D PART II
1/48 Revell

DETAIL

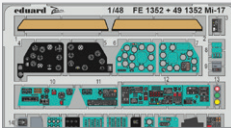

BIG49374 Mi-17
1/48 AMK

DETAIL



BIG49375 F-86D
1/48 Revell

DETAIL



BIG49376 PV-1 PART I
1/48 Academy

DETAIL

BRASSIN



634039 A-20G LööK
1/32 ICM

DETAIL



644220 Hurricane Mk.I LööK
1/48 Hobby Boss

DETAIL



644222 FM-2 LööK
1/48 Eduard

DETAIL



644223 MiG-17F LööK
1/48 AMMO

DETAIL

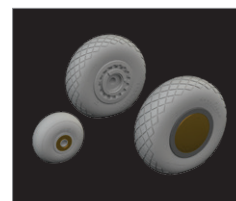

632197 A-20G wheels
1/32 ICM

DETAIL



635033 Sd.Kfz. 251/1 Ausf. C
radio equipment PRINT
1/35 Academy

DETAIL

BRASSIN

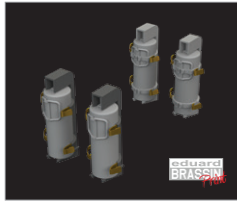

635034 WWII German fire extinguishers **PRINT** 1/35

DETAIL

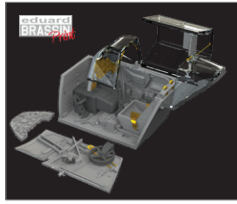

648875 Bf 109F cockpit w/ early seat **PRINT** 1/48 Eduard

DETAIL



648880 Bf 109F wheel bays rounded **PRINT** 1/48 Eduard

DETAIL



648881 Bf 109F wheel bays angular **PRINT** 1/48 Eduard

DETAIL



648882 F-4E wheels 1/48 Meng

DETAIL

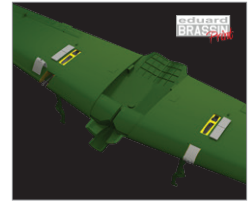

648883 A6M3 gun bays short barrel **PRINT** 1/48 Eduard

DETAIL

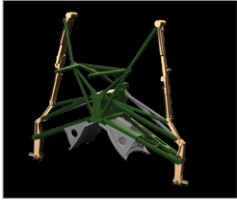

648886 FM-2 undercarriage legs **BRONZE** 1/48 Eduard

DETAIL



648887 FM-2 wheels 1/48 Eduard

DETAIL

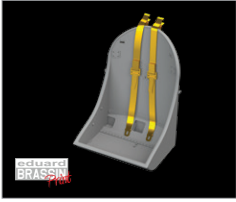

648888 FM-2 seat **PRINT** 1/48 Eduard

DETAIL

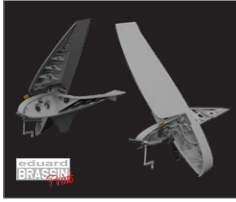

648889 FM-2 folding wings **PRINT** 1/48 Eduard

DETAIL

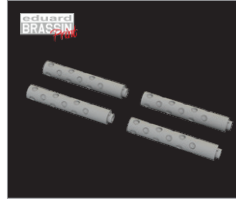

648890 FM-2 gun barrels **PRINT** 1/48 Eduard

DETAIL



648891 F-104A/C airbrakes **PRINT** 1/48 Kinetic/Eduard

DETAIL

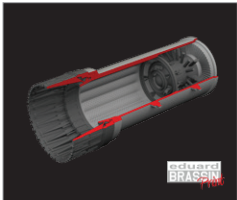

648892 F-104A/C exhaust nozzle **PRINT** 1/48 Kinetic/Eduard

DETAIL

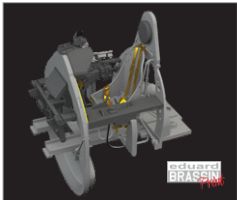

648895 FM-2 cockpit **PRINT** 1/48 Eduard

DETAIL



672317 Bf 109F undercarriage legs **BRONZE** 1/72 Eduard

DETAIL

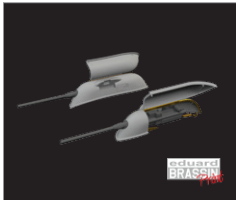

672326 Bf 109F/G/K gun pods **PRINT** 1/72 Eduard

DETAIL

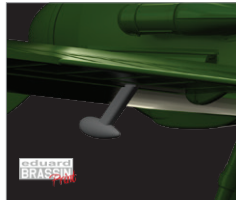

672329 Bf 109 balance weights **PRINT** 1/72 Eduard

DETAIL



672330 MiG-29 wheels 1/72 Great Wall Hobby

DETAIL

LööKplus



634040 Spitfire Mk.Ia **LööKplus** 1/32 Kotare

DETAIL

LööKplus

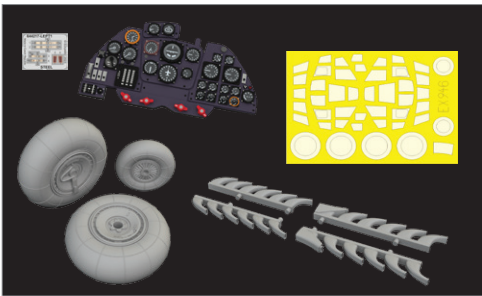

644221 Do 335A **LööKplus** 1/48 Tamiya

DETAIL

BIGSIN

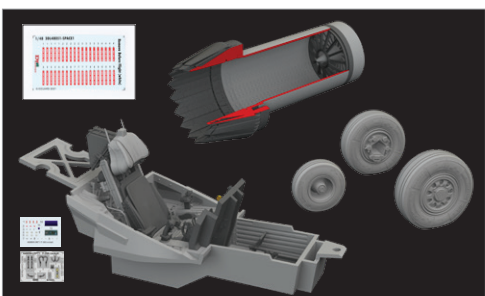

SIN648108 F-35A 1/48 Tamiya

DETAIL

BIGSIN



SIN648109 F-4E armament 1/48 Meng

DETAIL

The ProfiPACK edition kit of German WWII fighter plane Bf 109F-4 in 1/72 scale.

BASIC INFO:

NAME: **Bf 109F-4**

CAT. NO.: 70155

SCALE: 1/72

EDITION: ProfiPACK

CONTENTS:

SPRUES: Eduard

PE-SETS: Yes, pre-painted

PAINTING MASK: Yes

MARKING OPTIONS: 6

BRASSIN: No

RELATED PRODUCTS:

672313 Bf 109F propeller early PRINT (Brassin)

672314 Bf 109F propeller late PRINT (Brassin)

672315 Bf 109F gun barrels PRINT (Brassin)

672316 Bf 109F wheels PRINT (Brassin)

672317 Bf 109F undercarriage legs BRONZE (Brassin)

672318 Bf 109F radio compartment PRINT (Brassin)

672321 Bf 109F/G external fuel tanks (Brassin)

672322 Bf 109F wheel bays rounded PRINT (Brassin)

672323 Bf 109F/G wheels bays angular PRINT (Brassin)

672324 Bf 109 SC250 bomb (Brassin)

672325 Bf 109F/G exhaust stacks PRINT (Brassin)

672326 Bf 109F/G/K gun pods PRINT (Brassin)

672329 Bf 109 balance weights PRINT (Brassin)

3DL72018 Bf 109F SPACE (3D Decal Set)

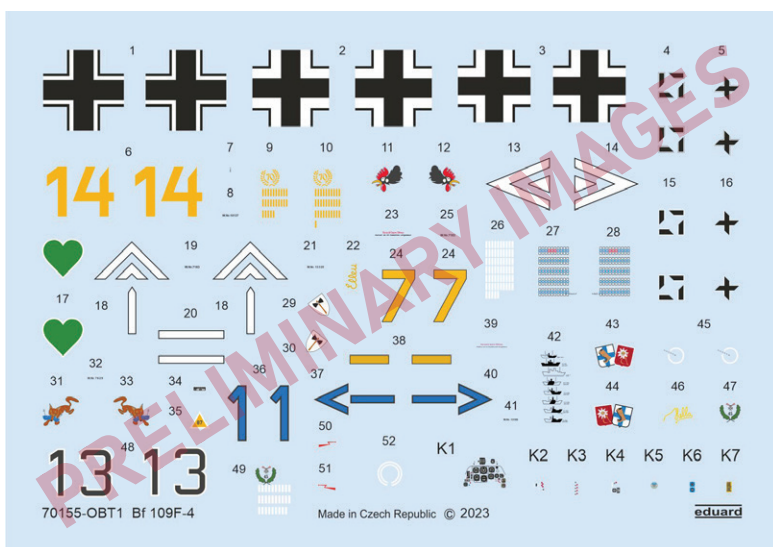
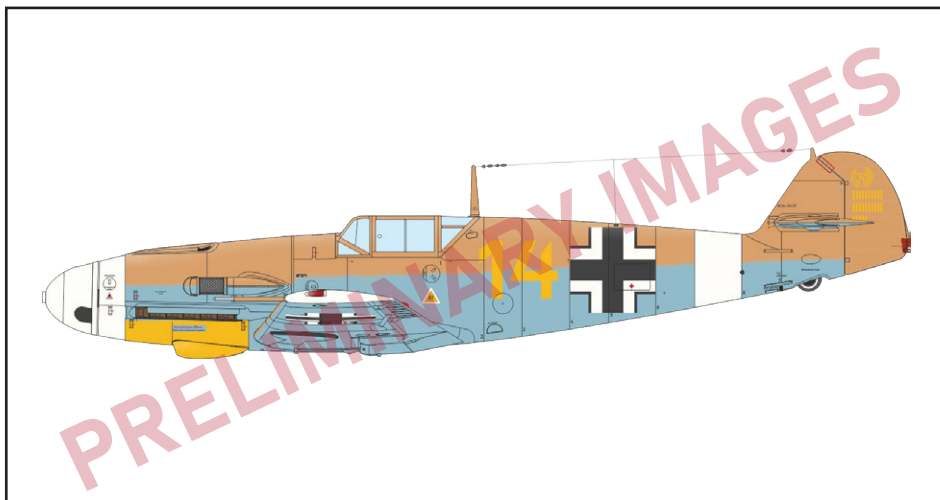

KIT PARTS

L>

70150 L

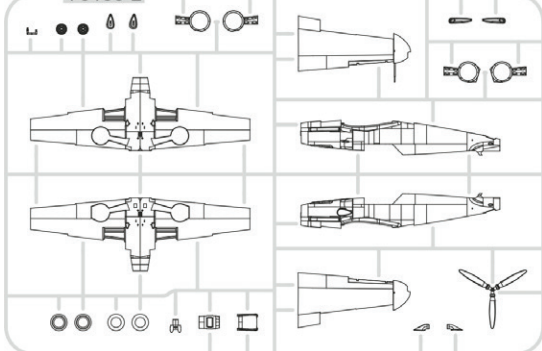

U>

70150 U

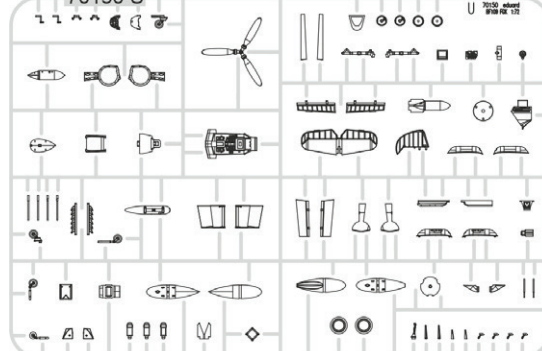

H>

70150 H

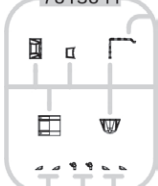

W>

70150 W

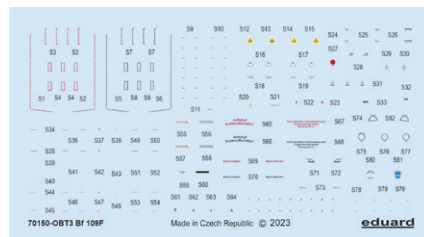
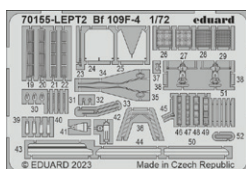
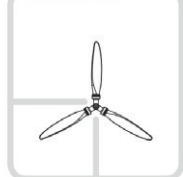

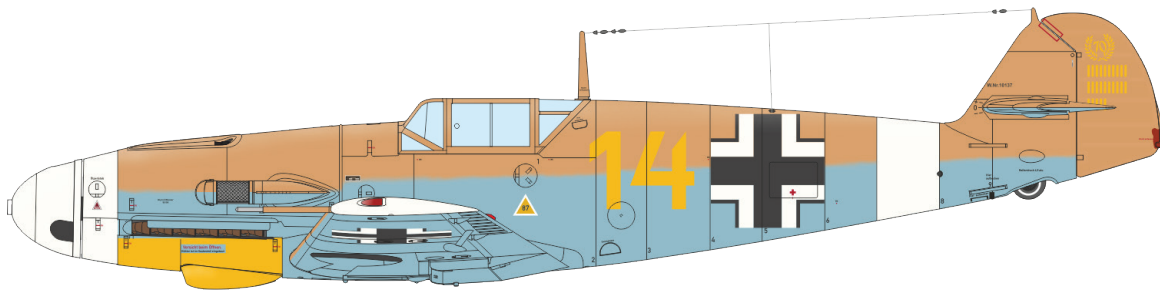

Bf 109F-4/Trop, WNr. 10137, Oblt. Hans-Joachim Marseille,
CO of 3./JG 27, Ain-el-Gazala, Libya, June 1942

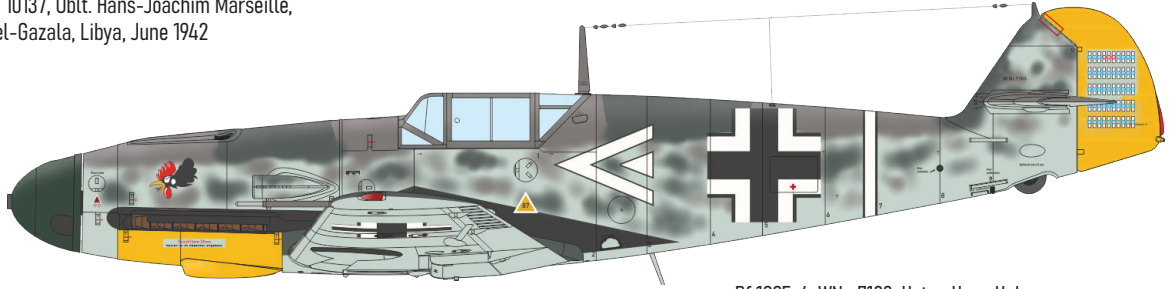

Bf 109F-4, WNr. 7183, Hptm. Hans Hahn,
III./JG 2, St. Pol, France, October 1941

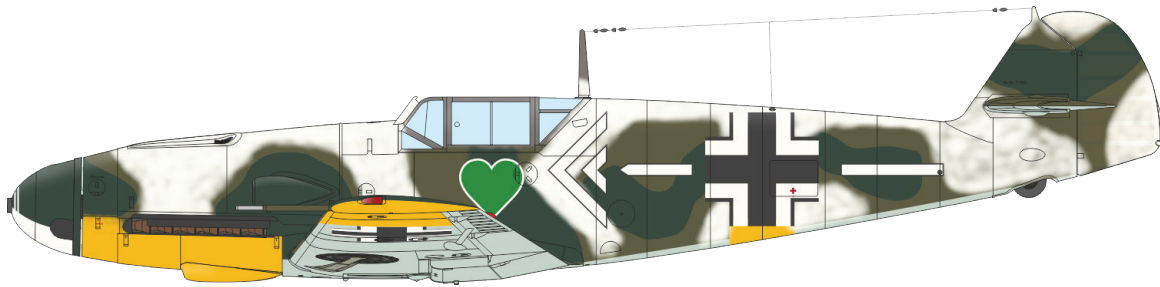

Bf 109F-4, Maj. Hannes Trautloft, CO of JG 54, Relbitsy,
the Soviet Union, March 1942

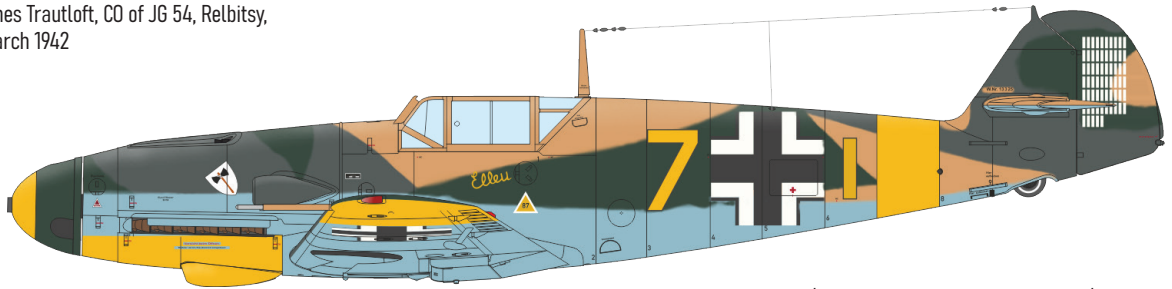

Bf 109F-4/Z, WNr. 13325, Oblt. Viktor Bauer, 9./JG 3,
Shchigry, the Soviet Union, June 1942

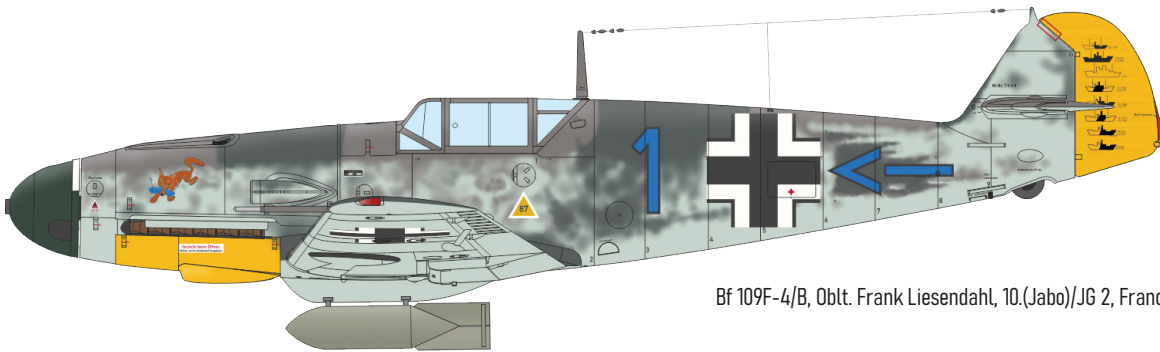

Bf 109F-4/B, Oblt. Frank Liesendahl, 10.(Jabo)/JG 2, France, June 1942

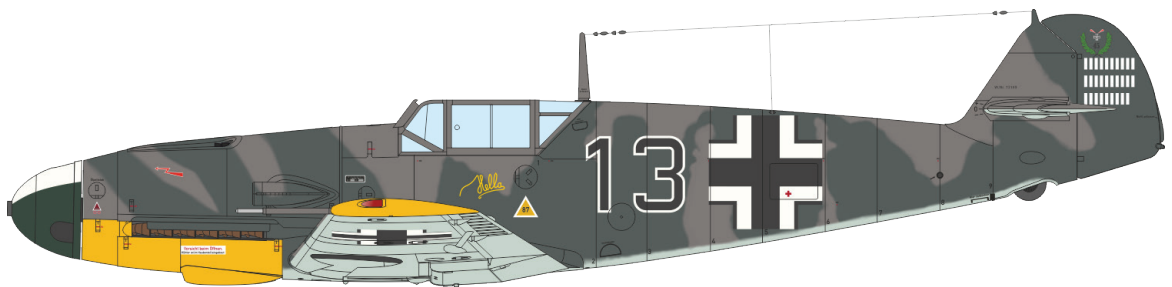

Bf 109F-4, WNr. 13169, Fw. Heinrich Bartels,
8./JG 5, Petsamo, Finland, September 1942

The Limited edition kit of the US jet fighter plane F-104C Starfighter in 1/48 scale. The selection of aircraft is focused on the units taking part in the Vietnam War.

BASIC INFO:

NAME: **THE ZIPPER**

CAT. NO.: 11169

SCALE: 1/48

EDITION: LIMITED

CONTENTS:

SPRUES: Kinetic

PE-SETS: Yes, pre-painted

PAINTING MASK: Yes

MARKING OPTIONS: 7

BRASSIN: Yes, sensor, wheels and seat

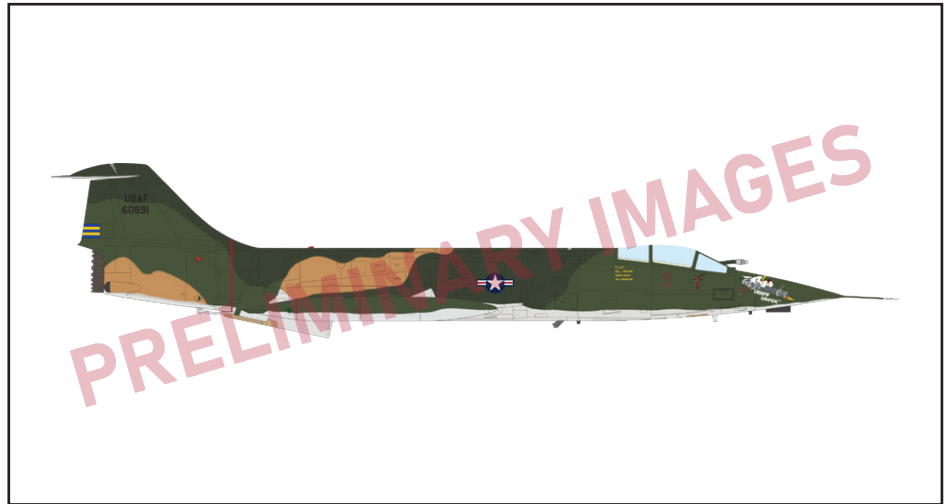

RELATED PRODUCTS:

FE1270 F-104A/C seatbelts STEEL (PE-Set)

644158 F-104C LööK (Brassin)

644168 F-104C LööKplus (Brassin)

648028 AIM-9B Sidewinder (Brassin)

648188 M 117 bomb early (Brassin)

648231 LAU-3/A (Brassin)

648389 BLU-27 (Brassin)

648891 F-104A/C airbrakes PRINT (Brassin)

648892 F-104A/C exhaust nozzle PRINT (Brassin)

3DL48064 F-104C SPACE (3D Decal Set)

EX851 F-104A/C TFace (Mask)

KIT PARTS

B>

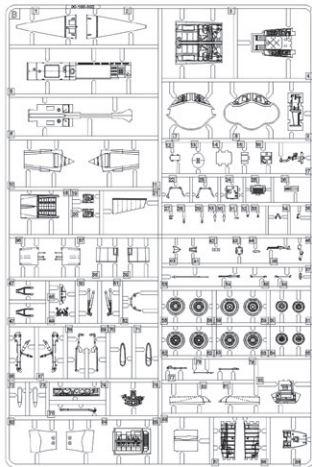

C>

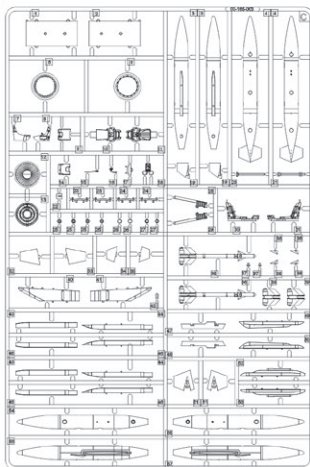

G>

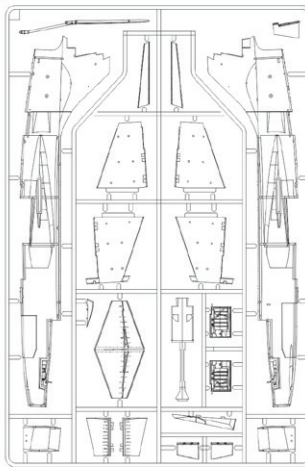

D>

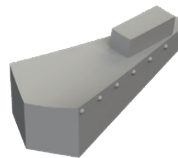
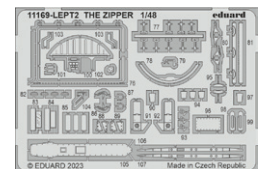
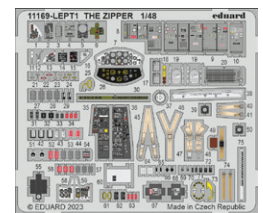
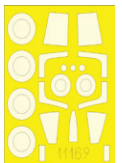

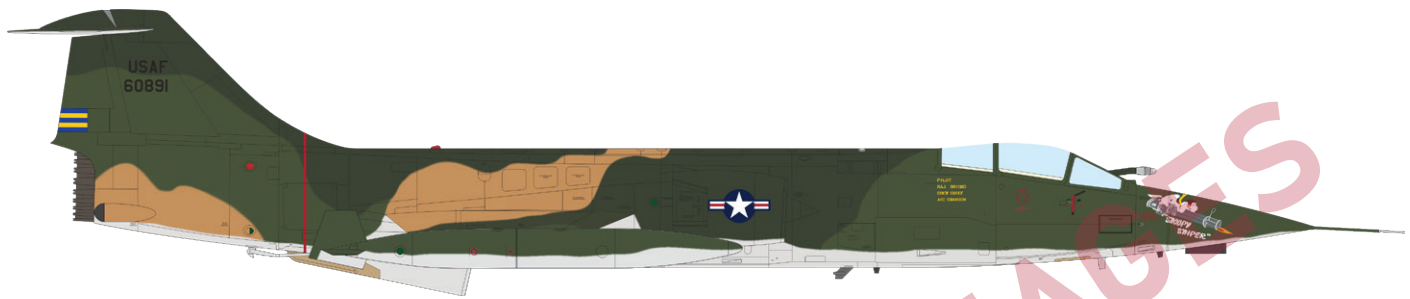

F-104C-5-L0, 56-0891, Maj. Herb Drisko, 435th TFS, 479th TFW, Udorn RTAFB, Thailand, 1967

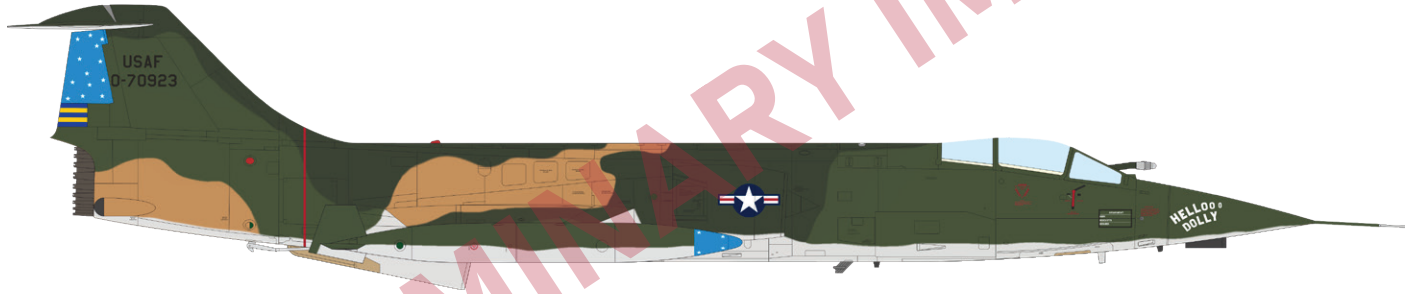

F-104C-10-L0, 57-0923, Lt. Col. Robert Preciado, 435th TFS, 479th TFW, Udorn RTAFB, Thailand, July 1967

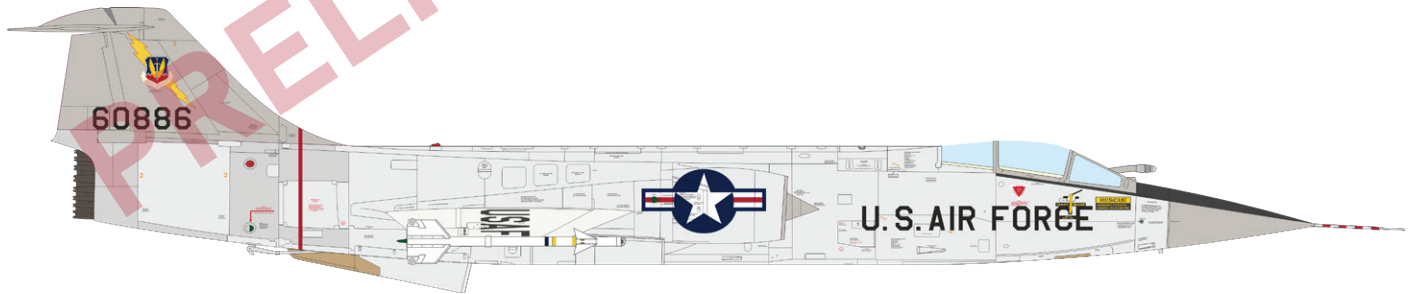

F-104C-5-L0, 56-0886, 476th TFS, 479th TFW, Da Nang AB, South Vietnam, April 1965

+ four more marking options

F-104C-5-L0, 56-0891, Col. George Laven Jr., 479th TFW, George AFB, California, United States, 1959

F-104C-5-L0, 56-0910, Capt. Jim Trice, 435th TFS, 479th TFW, Udorn RTAFB, Thailand, 1967

F-104C-5-L0, 56-0938, Maj. Bobby Betsworth, 435th TFS, 479th TFW, Udorn RTAFB, Thailand, June-August 1967

F-104C-5-L0, 56-0898, Maj. Hugh Spencer, 435th TFS, 479th TFW, Udorn RTAFB, Thailand, 1967

The Limited edition kit of the US WWII aircraft carrier-based fighter FM-2 Wildcat in 1/48 scale. This version of the Wildcat was built by the Eastern Aircraft Division of General Motors and was easily recognizable thanks to taller fin. It was also the most potent of all Wildcats thanks to the more powerful engine.

BASIC INFO:

NAME: **WILDER CAT**

CAT. NO.: 11175

SCALE: 1/48

EDITION: LIMITED

CONTENTS:

SPRUES: Eduard

PE-SETS: Yes, pre-painted

PAINTING MASK: Yes

MARKING OPTIONS: 10

BRASSIN: No

RELATED PRODUCTS:

481119 FM-2 landing flaps (PE-Set)

644222 FM-2 LööK (Brassin)

648061 HVAR rockets (Brassin)

648886 FM-2 undercarriage legs BRONZE (Brassin)

648887 FM-2 wheels (Brassin)

648888 FM-2 seat PRINT (Brassin)

648889 FM-2 folding wings PRINT (Brassin)

648890 FM-2 gun barrels PRINT (Brassin)

648895 FM-2 cockpit PRINT (Brassin)

3DL48128 FM-2 SPACE (3D Decal Set)

EX965 FM-2 TFace (Mask)

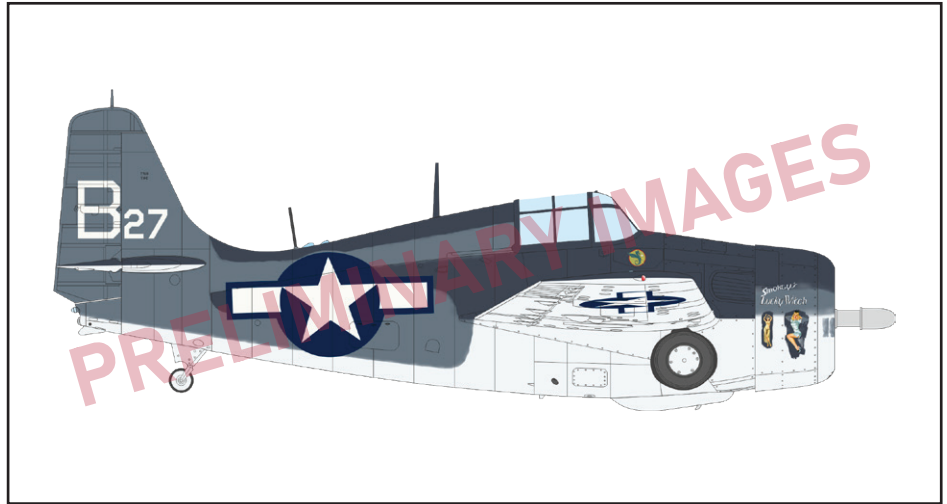

KIT PARTS

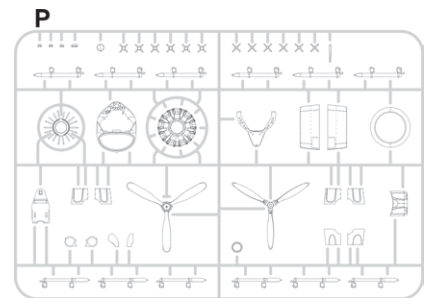
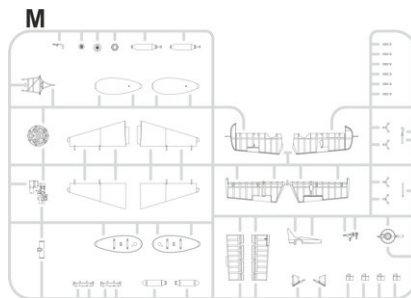
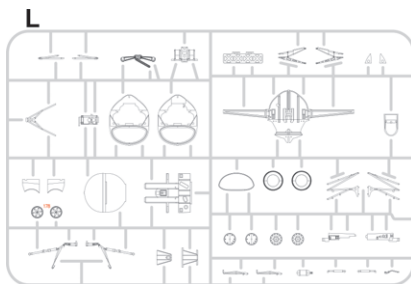
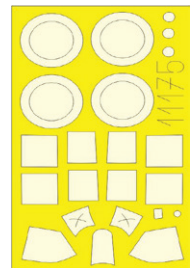
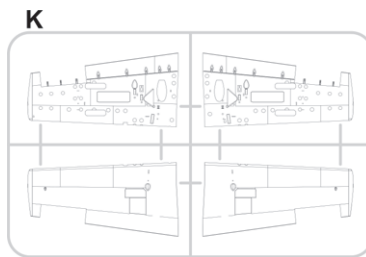
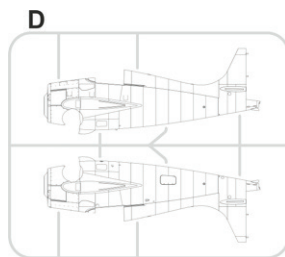
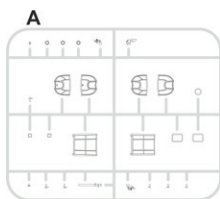

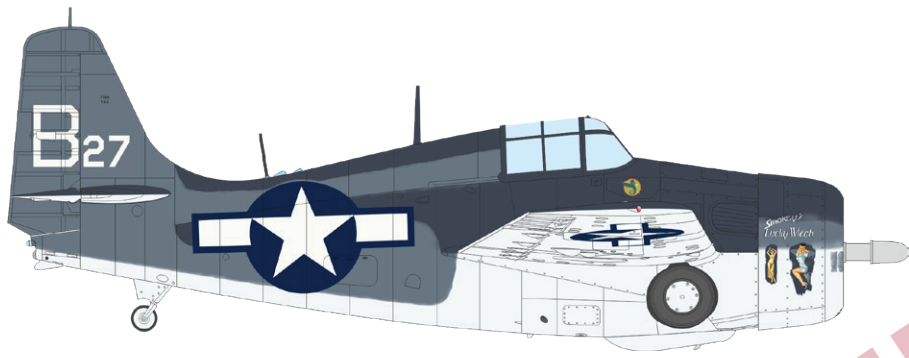

Ens. Darrell C. Bennett, VC-10,
USS Gambier Bay, August 1944

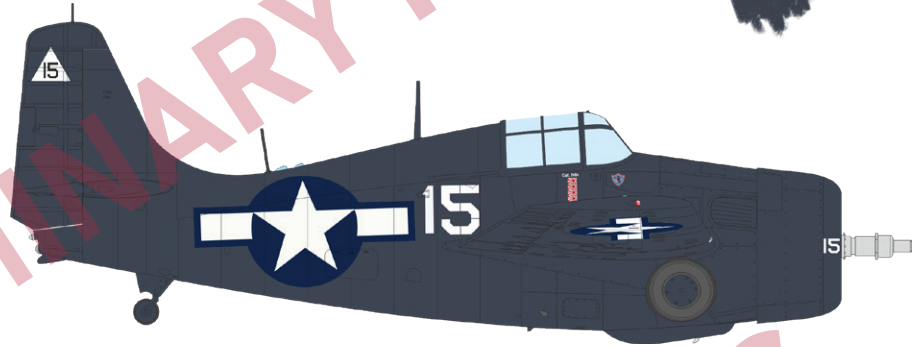
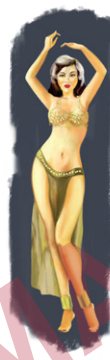

Lt. Leopold M. Ferko, VC-4, USS White Plains,
November 1944

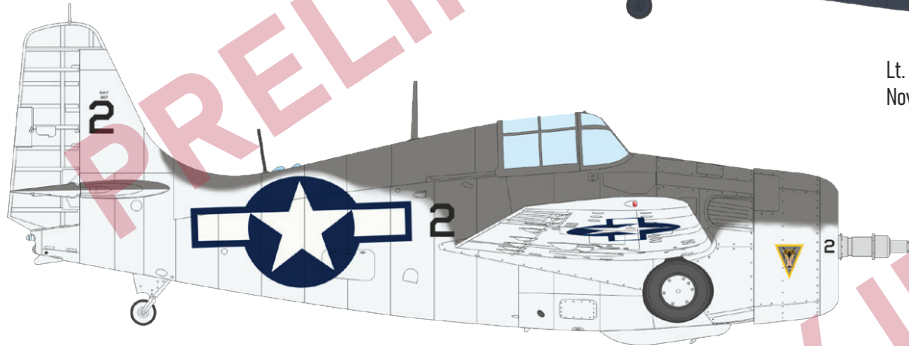

VC-69, USS Guadalcanal, spring/summer 1944

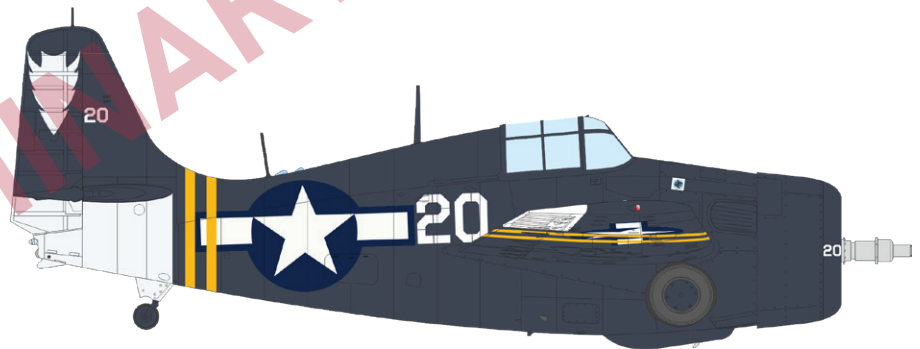

VC-8, Lt(jg) Harry N. O'Connor, USS Nehenta Bay,
August 5, 1945

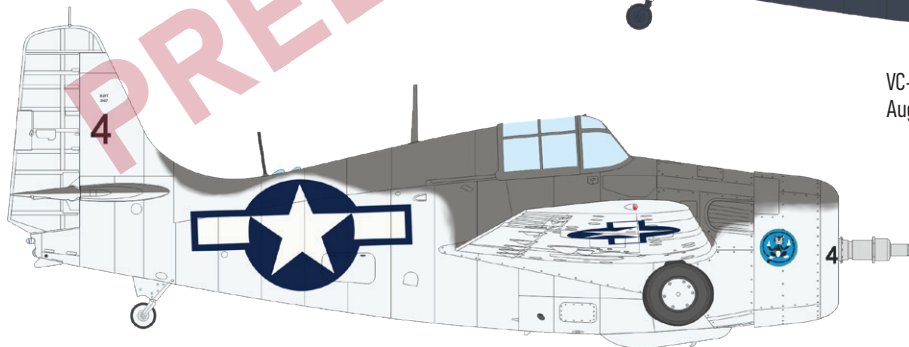

VC-80, USS Manila Bay, autumn 1944

+ five more marking options

- Lt. O'Neill, VC-13, USS Tripoli, spring 1944
- VC-93, Lt(jg) Robert Sullivan, USS Petrof Bay, Okinawa, April–May 1945
- VC-14, USS Hogatt Bay, November 1944
- VC-27, Lt. Ralph Elliot, Jr., USS Savo Island, January 1945
- JV640, Sub-Lt W. Park, No. 881 Squadron FAA, HMS Pursuit, August 1944

The Weekend edition kit of Japanese WWII naval fighter plane A6M3 Zero Type 32 in 1/48 scale. This version of Zero had wing of reduced span and the folding wingtips were eliminated.

BASIC INFO:

NAME: **A6M3 Zero Type 32**

CAT. NO.: 84191

SCALE: 1/48

EDITION: Weekend edition

CONTENTS:

SPRUES: Eduard

PE-SETS: No

PAINTING MASK: No

MARKING OPTIONS: 4

BRASSIN: No

RELATED PRODUCTS:

481091 A6M3 Zero landing flaps (PE-Set)

481092 A6M3 Zero (PE-Set)

644185 A6M3 LööK (Brassin)

644189 A6M3 Zero LööKplus (Brassin)

648695 A6M undercarriage legs BRONZE (Brassin)

648786 A6M3 seat PRINT (Brassin)

648787 A6M3 tailwheel PRINT (Brassin)

648788 A6M3 cannon barrels & cockpit guns PRINT (Brassin)

648799 A6M3 wheels (Brassin)

648800 A6M3 cockpit PRINT (Brassin)

648801 A6M3 exhausts PRINT (Brassin)

648802 A6M3 Type 32 landing flaps PRINT (Brassin)

648808 A6M wheels w/smooth tire (Brassin)

648883 A6M3 gun bays short barrel (Brassin)

648884 A6M3 gun bays long barrel (Brassin)

3DL48088 A6M3 SPACE (3D Decal Set)

EX899 A6M3 Zero TFace (Mask)

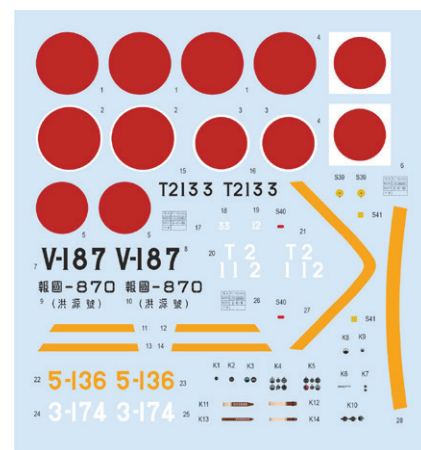
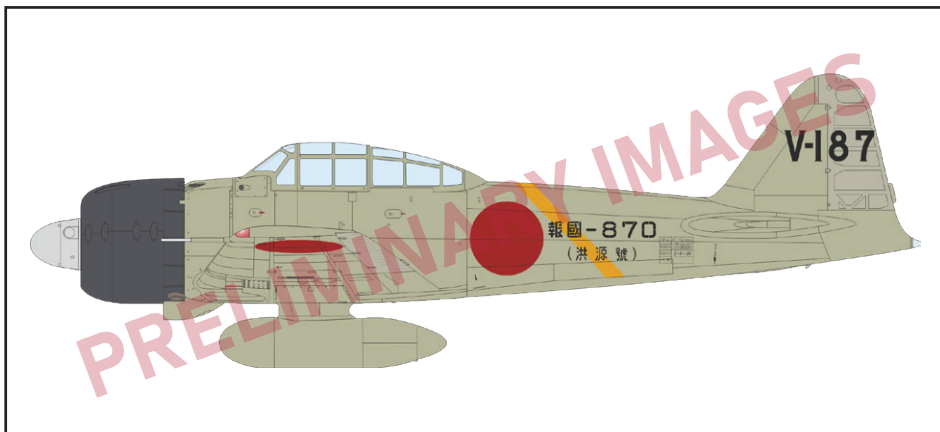

KIT PARTS

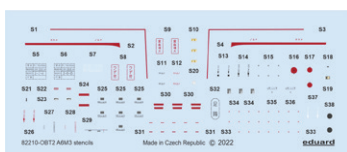
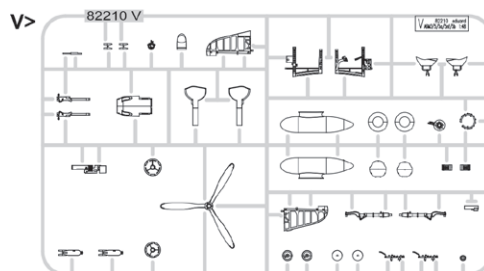
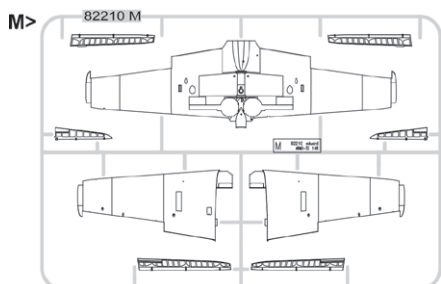
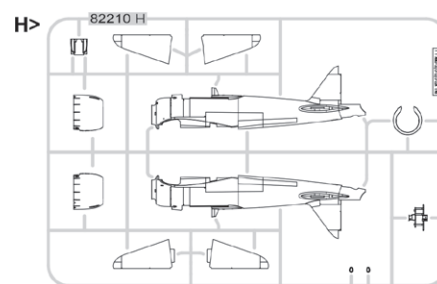
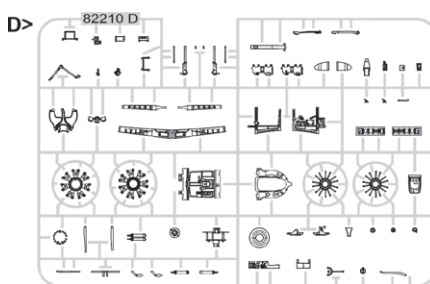
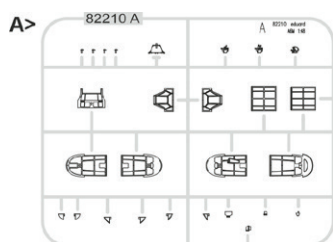

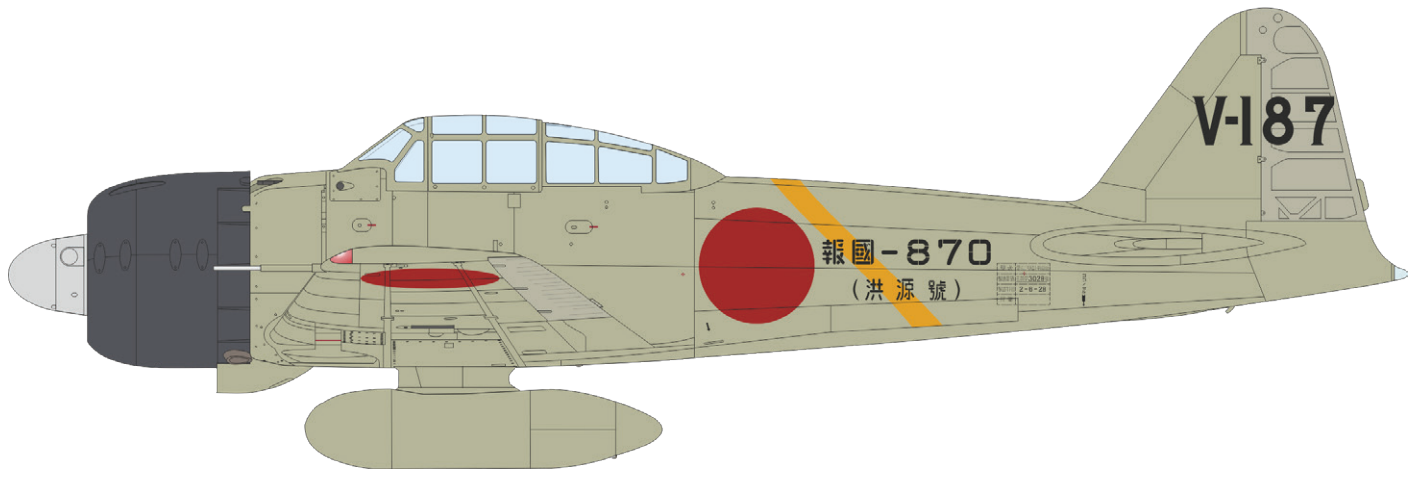

c/n 3028, Tainan Kōkūtai, Buna, New Guinea, August 1942

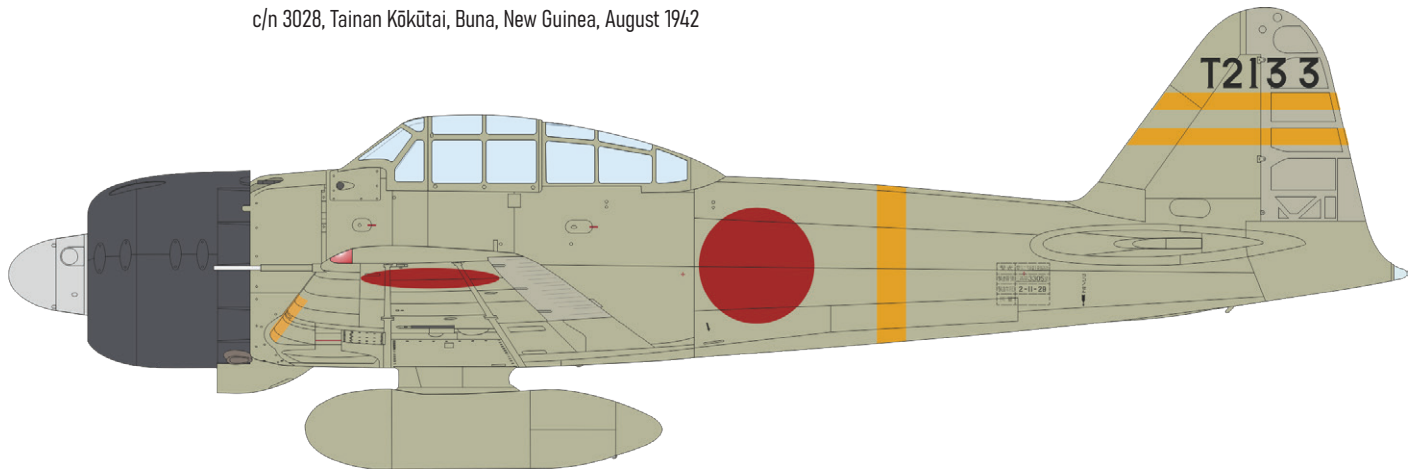

c/n 3305, Lt. (jg) Shibuya Kiyoharu, Buin, Bougainville, January 1943

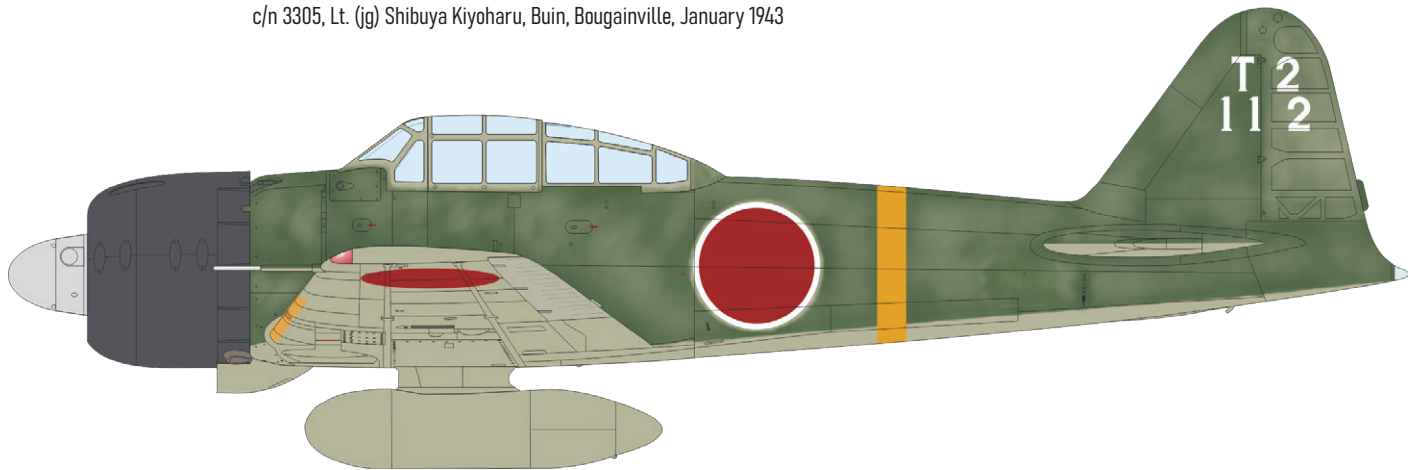

W/O Matsuo Hagiri, 204th Kōkūtai, Rabaul, New Britain, April 1943

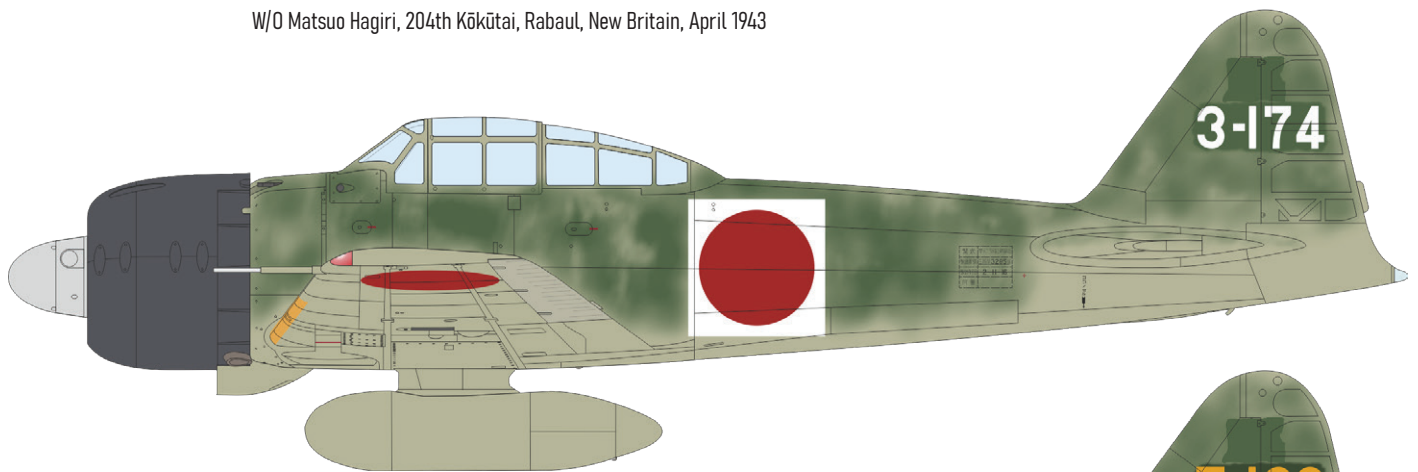

c/n 3285, Rabauru Kōkūbuntai, Ballale, end of the 1943



The ProfiPACK edition of Soviet Cold War jet aircraft MiG-21MF in 1/72 scale.

Re-release

BASIC INFO:

NAME: **MiG-21MF Fighter bomber**
Re-release

CAT. NO.: 70142

SCALE: 1/72

EDITION: ProfiPACK

CONTENTS:

SPRUES: Eduard

PE-SETS: Yes, pre-painted

PAINTING MASK: Yes

MARKING OPTIONS: 5

BRASSIN: No



RELATED PRODUCTS:

72689 MiG-21MF (PE-Set)

672181 MiG-21MF exhaust nozzle (Brassin)

672182 MiG-21MF wheels (Brassin)

672189 UB-16 rocket launchers for MiG-21 (Brassin)

672191 RS-2US missiles for MiG-21 (Brassin)

672193 MiG-21MF airbrakes (Brassin)

672197 MiG-21MF ejection seat (Brassin)

SIN67217 MiG-21MF armament (Brassin)

3DL72002 MiG-21MF SPACE (3D Decal Set)

CX511 MiG-21MF (Mask)

CX512 MiG-21MF TFace (Mask)

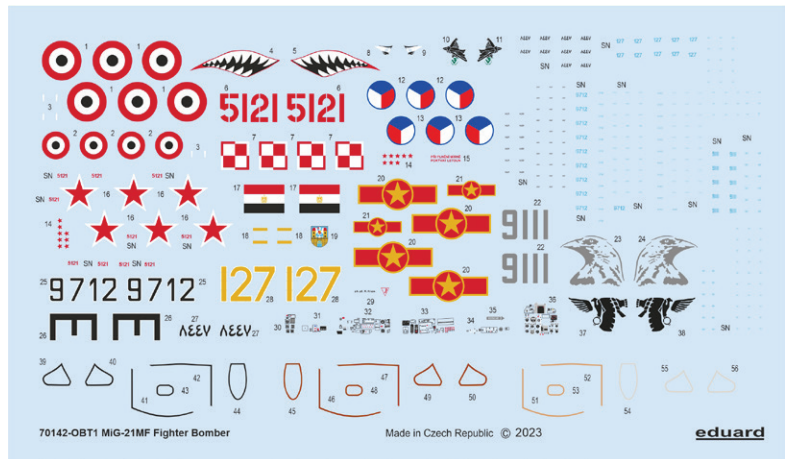

KIT PARTS

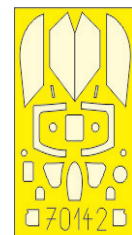
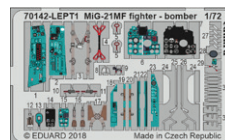
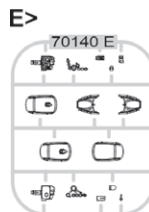
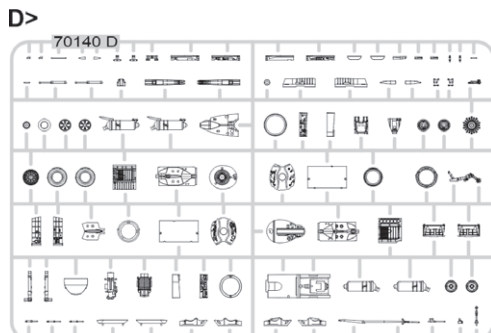
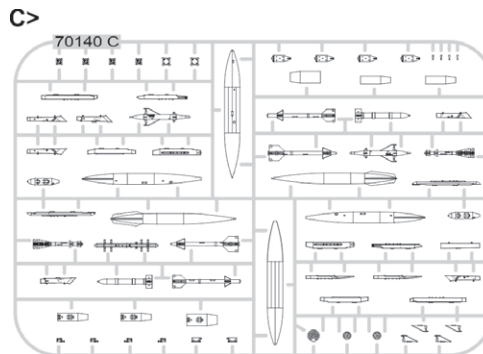
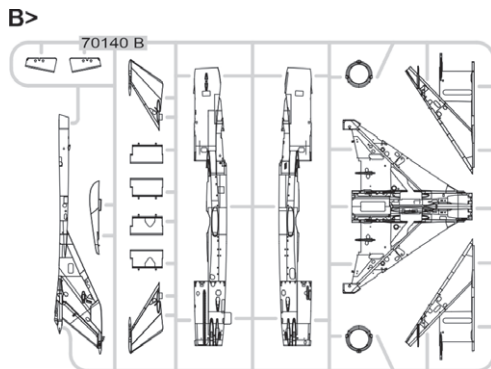

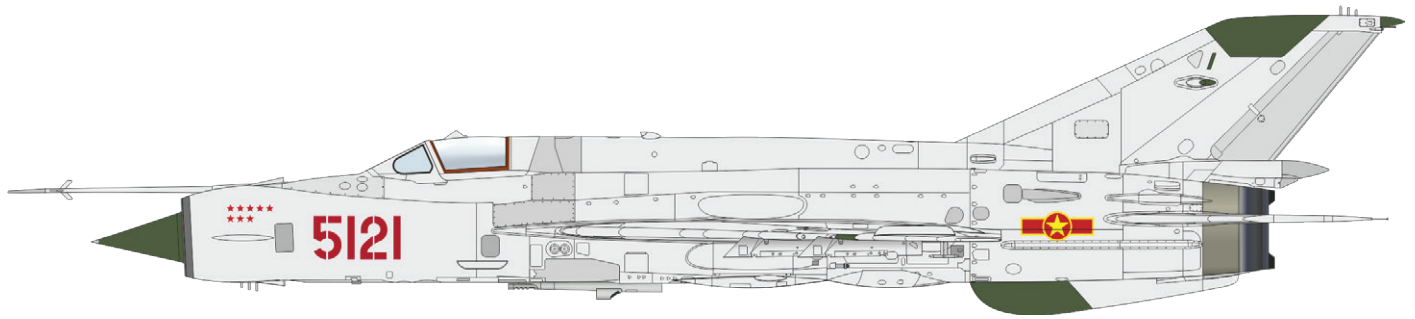

No. 5121, Pham Tuan, 921st Fighter Regiment, Noi Bai AB,
Democratic Republic of Vietnam, December 1972

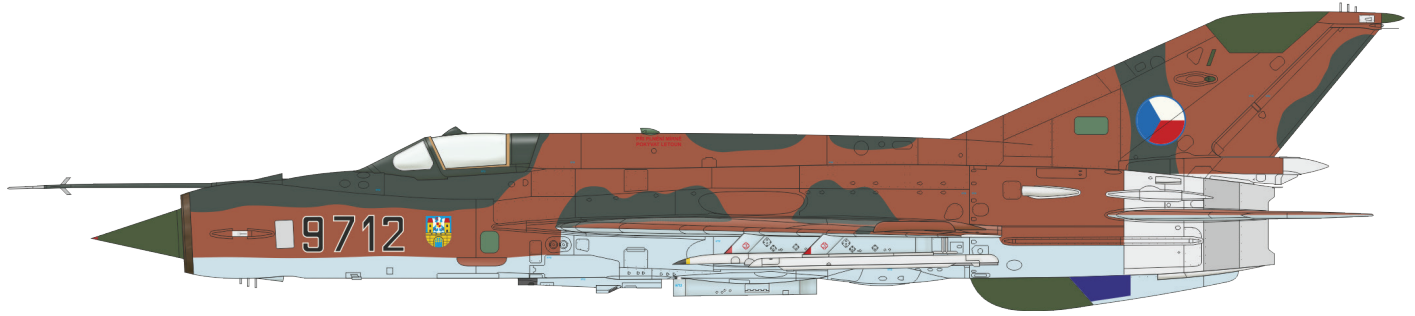

No. 9712, 9th Fighter Regiment, Bechyně, Czechoslovakia, 1989 - 1993

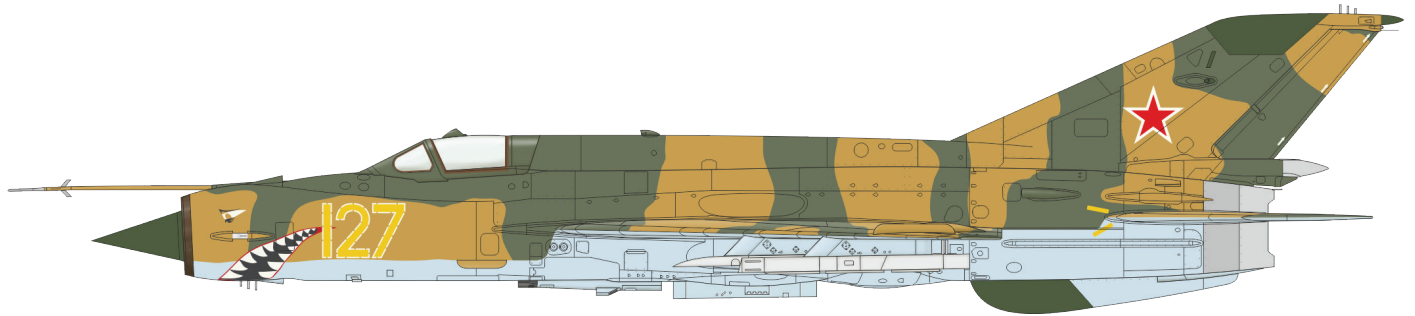

No. 127, 812th Training Air Regiment, Kharkov Higher Military Aviation School of Pilots,
Kupyansk Airfield, Soviet Union, August 1991

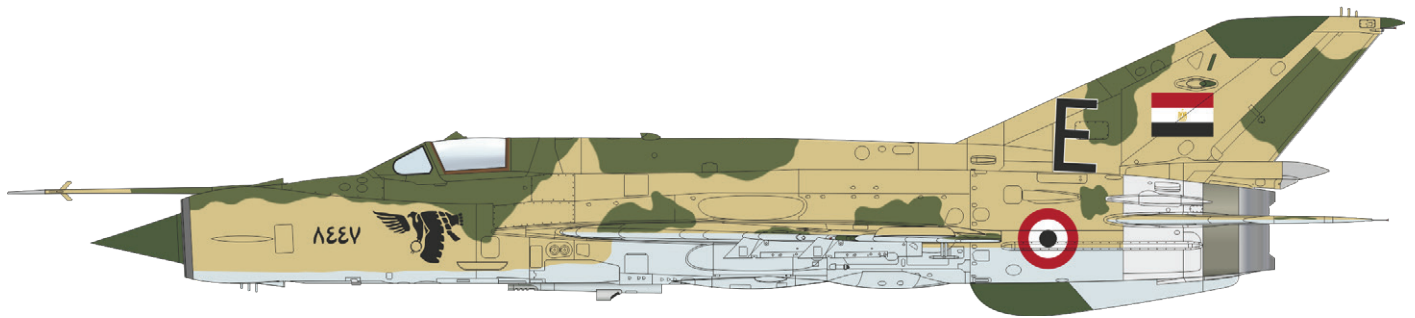

No. 8447, No. 46 Squadron, Egypt, 1973

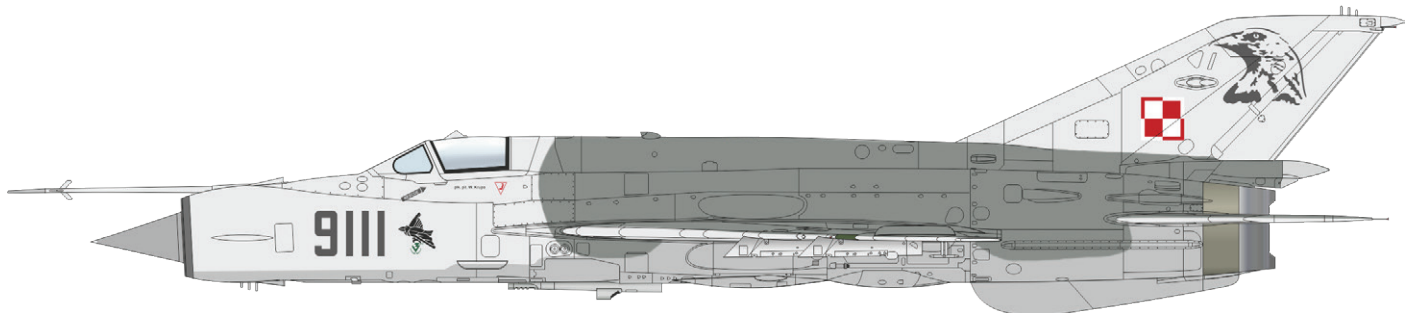

No. 9111, 3. Eskadrą Lotnictwa Taktycznego, Poznań - Krzesiny, Poland, 2002

32484 A-20G bomb bay
1/32 HKM

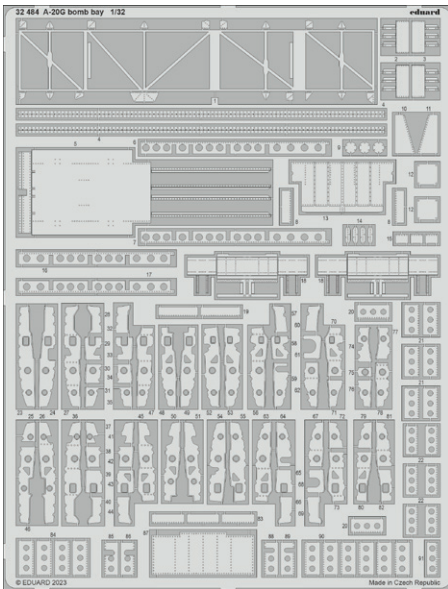

32485 A-20G main wheel wells
1/32 HKM

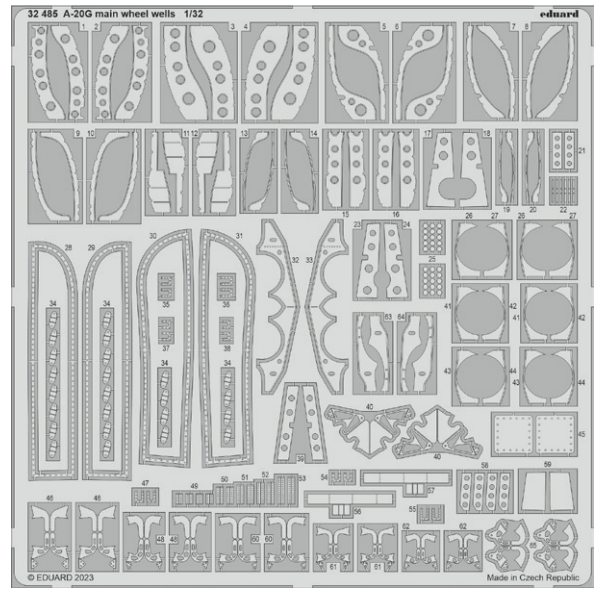

481118 F-16 reinforcement straps STEEL
1/48 Kinetic

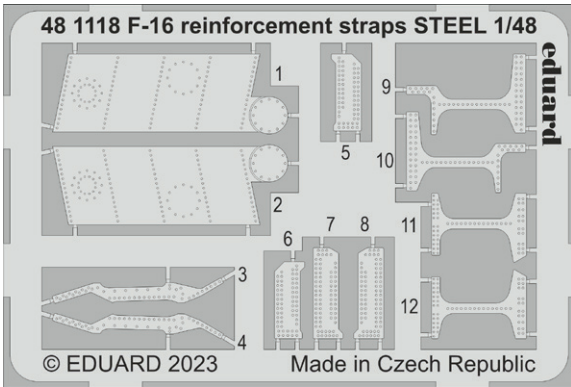

481119 FM-2 landing flaps
1/48 Eduard

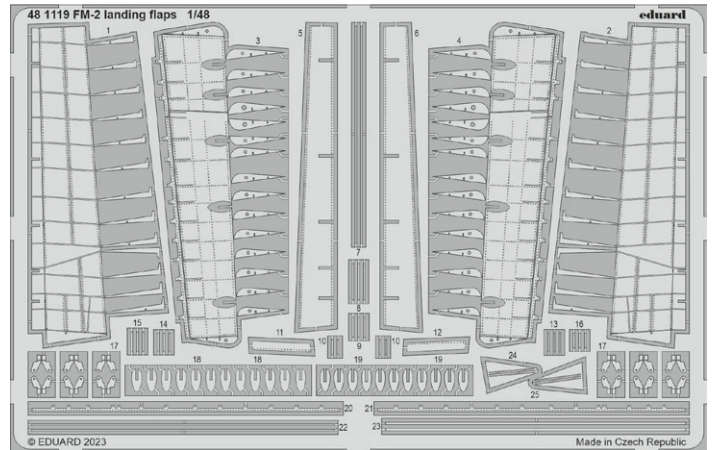

491369 F-16D Block 30
1/48 Kinetic

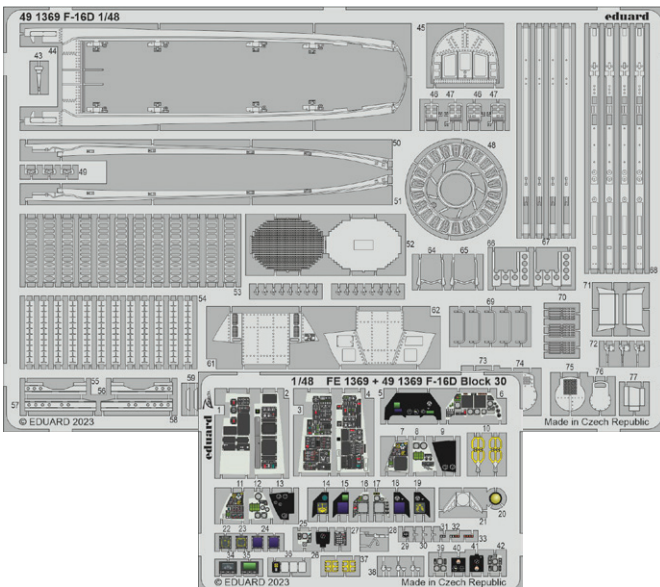

491370 F-16D Block 40
1/48 Kinetic

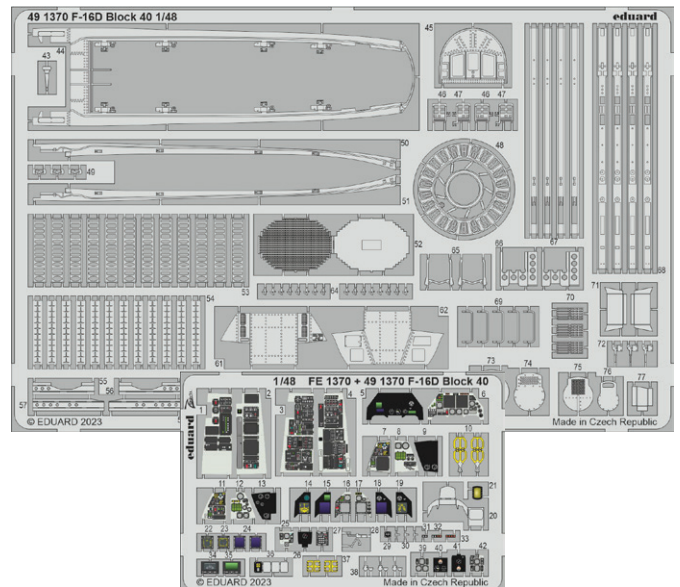

491371 F-16D Block 50
1/48 Kinetic

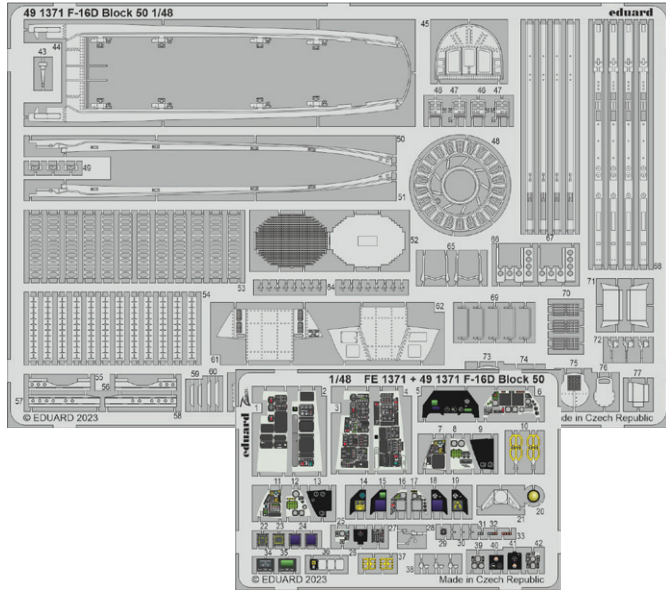

491373 A-10C
1/48 Academy

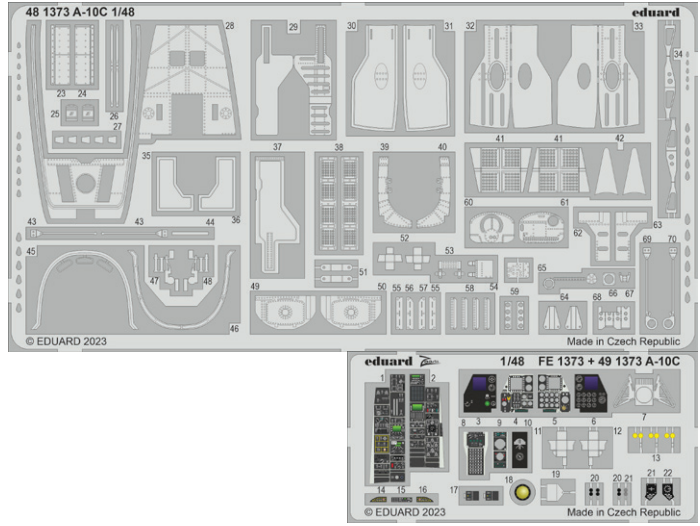

73805 OV-10A
1/72 ICM

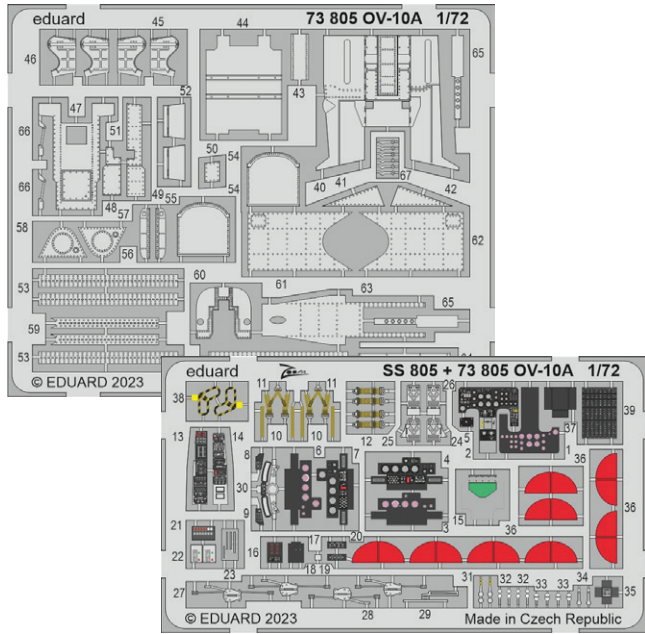

FE1369 F-16D Block 30
1/48 Kinetic

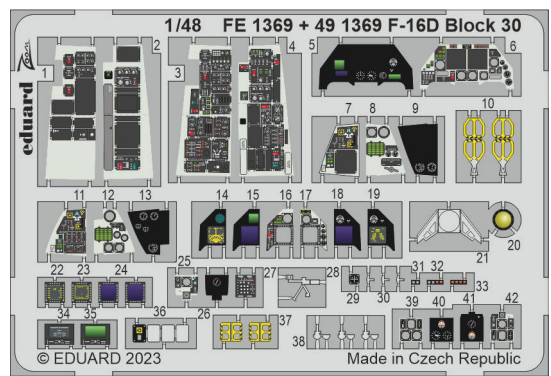

FE1370 F-16D Block 40
1/48 Kinetic

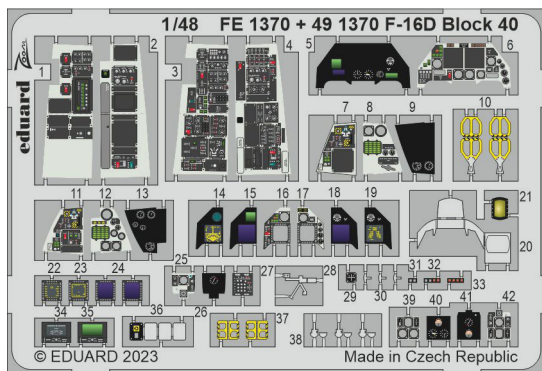

FE1371 F-16D Block 50
1/48 Kinetic

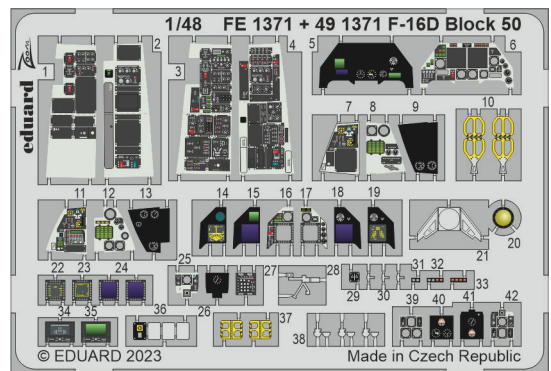

FE1372 F-16D Block 30/40/50 seatbelts STEEL
1/48 Kinetic

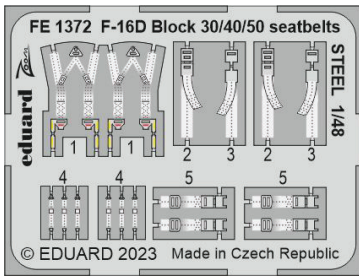

FE1373 A-10C
1/48 Academy

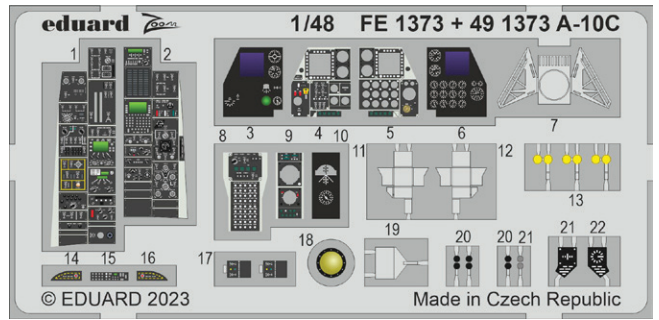

FE1374 A-10C seatbelts STEEL
1/48 Academy

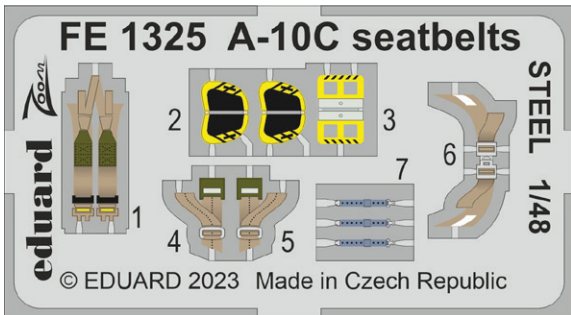

FE1375 A6M3 Zero Type 32 Weekend
1/48 Eduard

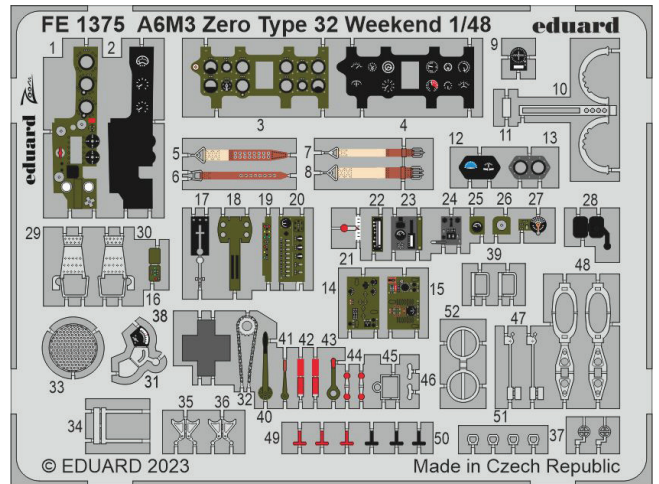

SS805 OV-10A
1/72 ICM

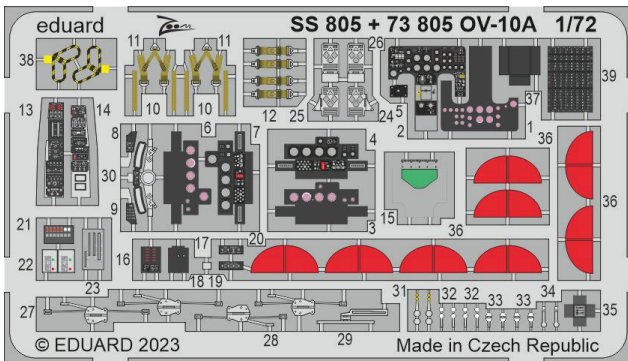

ER32001 Single riveting rows
1/32

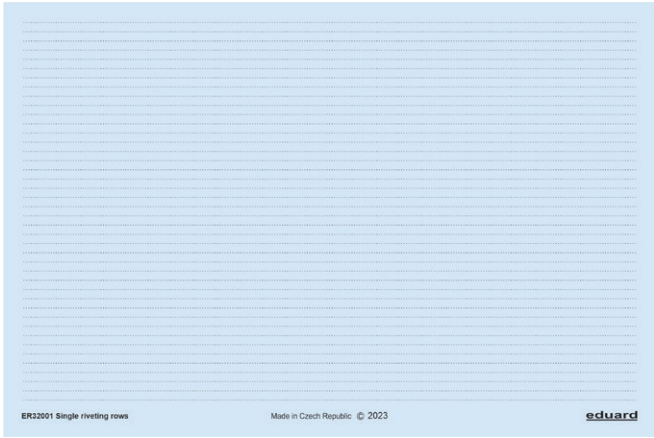

ER48006 Single riveting rows
1/48



ER72001 Single riveting rows
1/72



D72045 Bf 109F stencils
1/72 Eduard

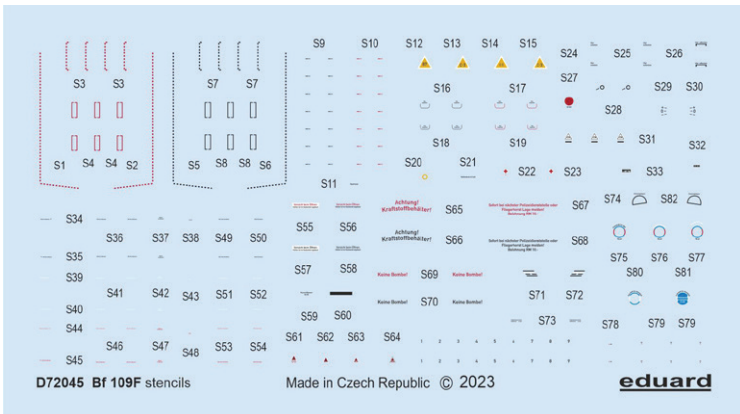

3DL48127 Bf 110G-4 SPACE
1/48 Eduard

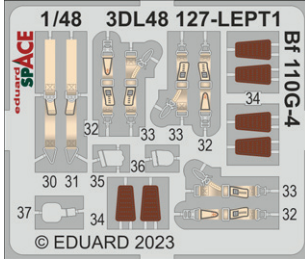
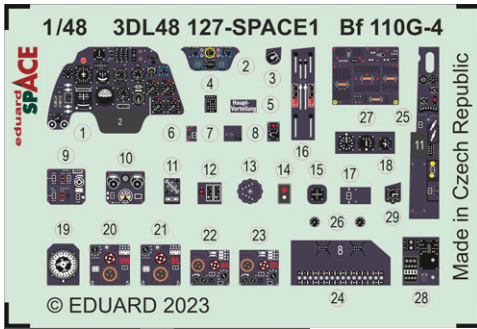

3DL48129 F-16D Block 30 SPACE
1/48 Kinetic

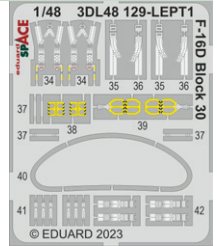
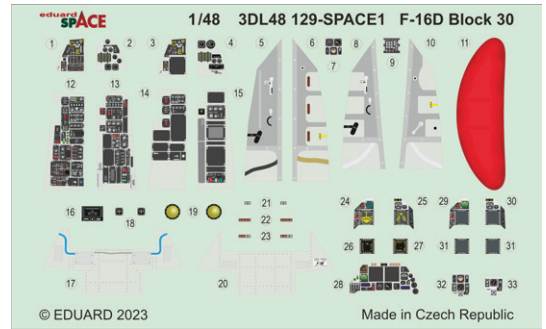

3DL48130 F-16D Block 40 SPACE
1/48 Kinetic

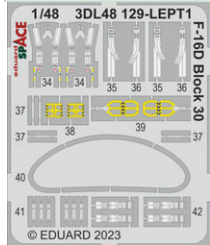
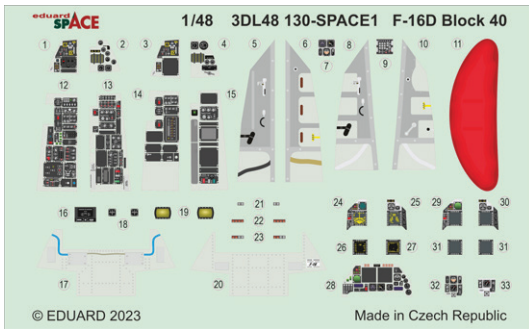

3DL48131 F-16D Block 50 SPACE
1/48 Kinetic

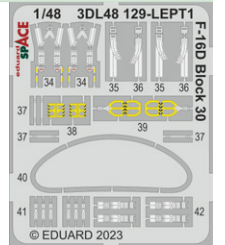
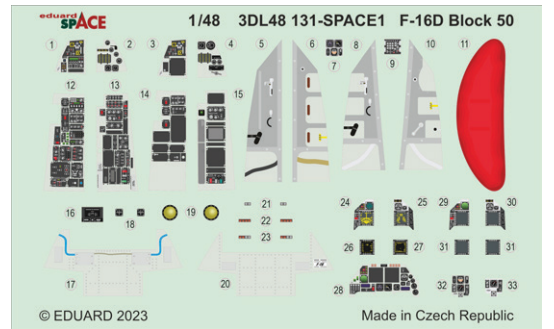

3DL48132 A-10C SPACE
1/48 Academy

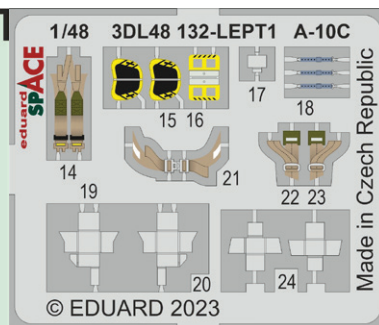
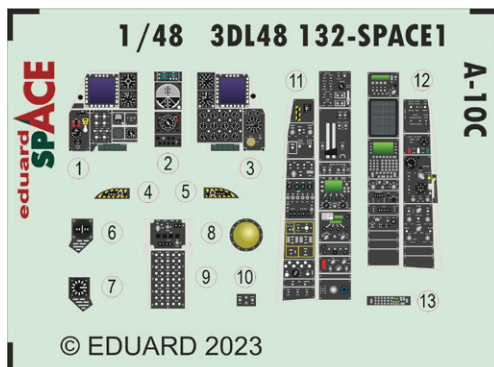

634039 A-20G Löök 1/32 ICM

Löök set - Brassin pre-painted dashboard and STEEL seatbelts for A-20G in 1/32 scale. Easy to assemble, replaces plastic parts. Recommended kit: HKM

Set contains:

- resin: 3 parts
- 3D print: 2 parts
- decals: no
- photo-etched details: yes, pre-painted
- painting mask: no

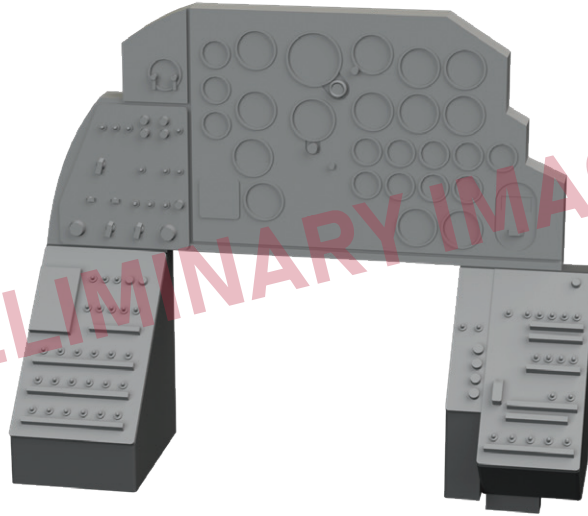

644220 Hurricane Mk.I Löök 1/48 Hobby Boss

Löök set - Brassin pre-painted dashboard and STEEL seatbelts for Hurricane Mk.I in 1/48 scale. Easy to assemble, replaces plastic parts. Recommended kit: Hobby Boss

Set contains:

- resin: 2 parts
- decals: no
- photo-etched details: yes, pre-painted
- painting mask: no

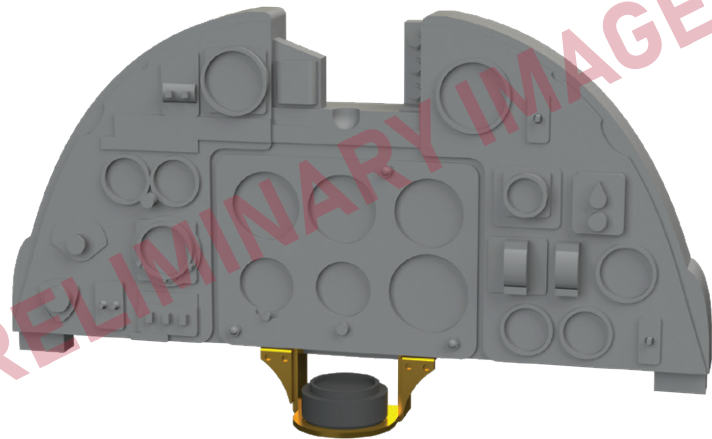
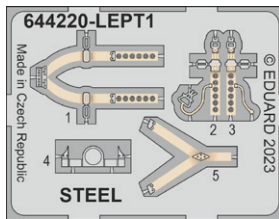

644222 FM-2 Löök 1/48 Eduard

Löök set - Brassin pre-painted dashboard and STEEL seatbelts for FM-2 in 1/48 scale. Easy to assemble, replaces plastic parts. Recommended kit: Eduard

Set contains:

- resin: 1 part
- 3D print: 1 part
- decals: no
- photo-etched details: yes, pre-painted
- painting mask: no

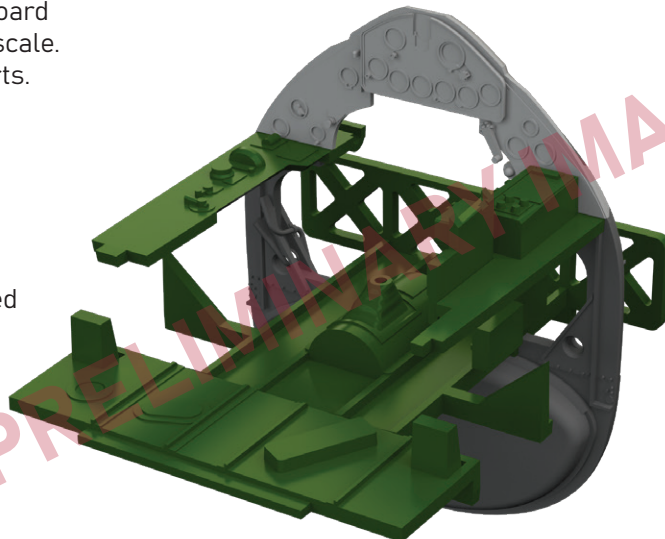

644223 MiG-17F LööK 1/48 AMMO

LööK set - Brassin pre-painted dashboard and STEEL seatbelts for MiG-17F in 1/48 scale. Easy to assemble, replaces plastic parts. Recommended kit: AMMO

Set contains:

- resin: 1 part
- decals: no
- photo-etched details: yes, pre-painted
- painting mask: no

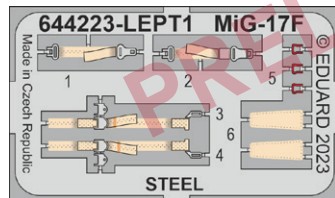

632197 A-20G wheels 1/32 ICM

Brassin set - the undercarriage wheels for A-20G in 1/32 scale. The set consists of the main wheels and a nose wheel. Easy to assemble, replaces plastic parts. Recommended kit: HKM

Set contains:

- resin: 3 parts
- 3D print: 2 parts
- decals: no
- photo-etched details: yes
- painting mask: yes

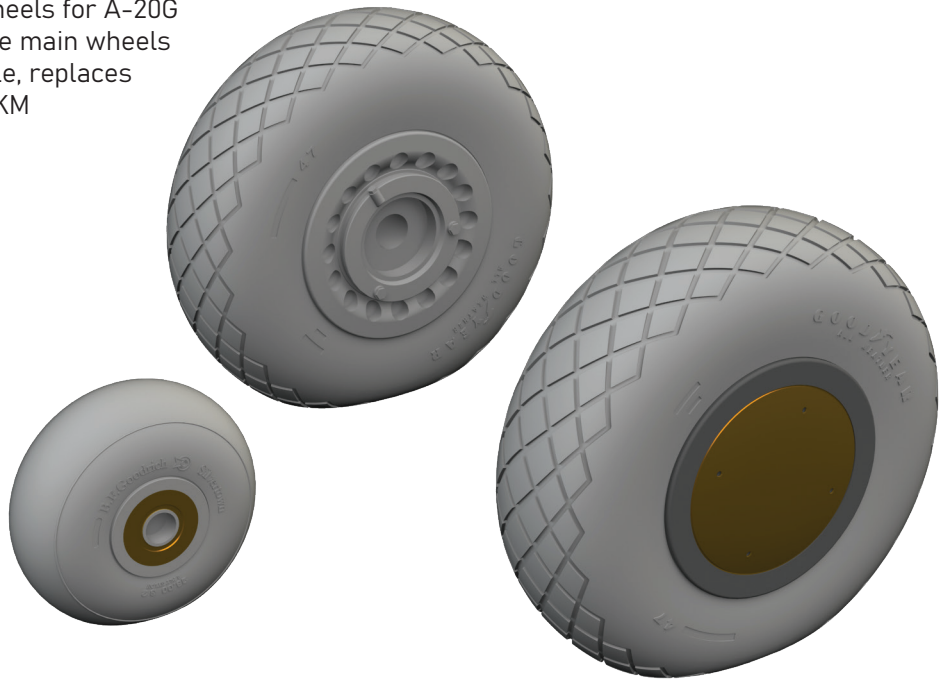

635033 Sd.Kfz. 251/1 Ausf. C radio equipment PRINT 1/35 Academy

Brassin set - pre-painted radio and equipment for Sd.Kfz. 251/1 Ausf. C in 1/35 scale. Made by direct 3D printing. Recommended kit: Academy

Set contains:

- 3D print: 14 parts
- resin: 1 part
- decals: yes
- photo-etched details: yes
- painting mask: no



635034 WWII German fire extinguishers PRINT 1/35

Brassin set - fire extinguishers for German WWII AFV in 1/35 scale. The set consists of 4 extinguishers. Made by direct 3D printing.

Set contains:

- 3D print: 6 parts
- decals: yes
- photo-etched details: yes
- painting mask: no

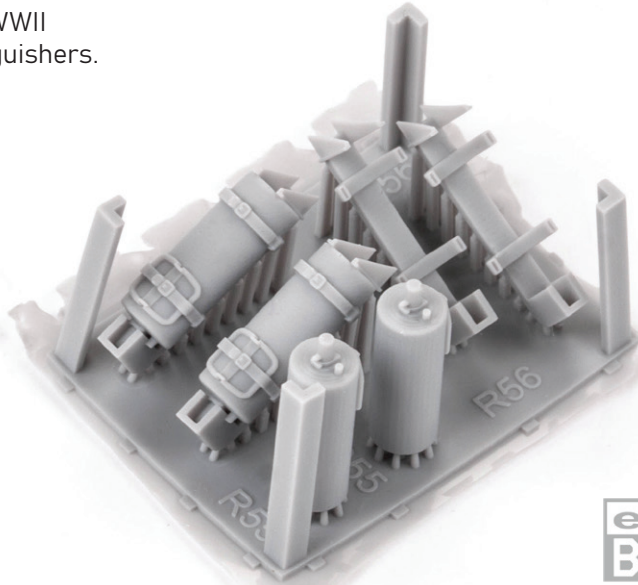
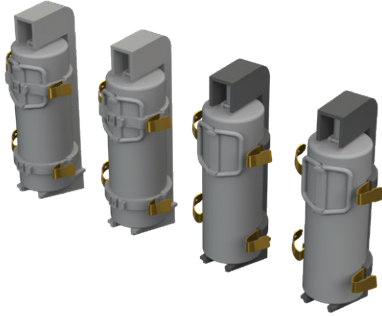

eduard
BRASSIN
Print

648875 Bf 109F cockpit w/ early seat PRINT 1/48 Eduard

Brassin set - cockpit for Bf 109F in 1/48 scale. Made by direct 3D printing. Recommended kit: Eduard

Set contains:

- 3D print: 17 parts
- resin: 1 part
- decals: yes
- photo-etched details: yes, pre-painted
- painting mask: no
- SPACE 3D decals: no

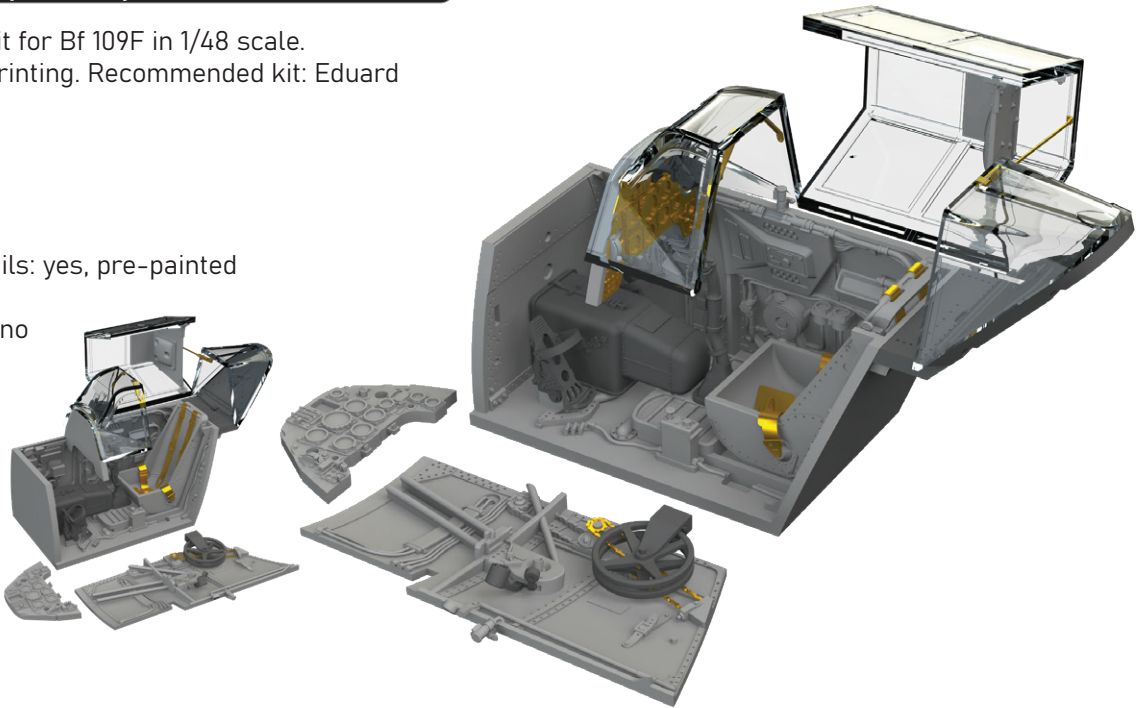

eduard
BRASSIN
Print

648880 Bf 109F wheel bays rounded PRINT 1/48 Eduard

Brassin set - rounded wheel bays for Bf 109F in 1/48 scale. Made by direct 3D printing. Recommended kit: Eduard

Set contains:

- 3D print: 2 parts
- decals: no
- photo-etched details: no
- painting mask: no



eduard
BRASSIN
Print

648881 Bf 109F wheel bays angular PRINT 1/48 Eduard

Brassin set - angular wheel bays for Bf 109F in 1/48 scale. Made by direct 3D printing. Recommended kit: Eduard

Set contains:

- 3D print: 2 parts
- decals: no
- photo-etched details: no
- painting mask: no

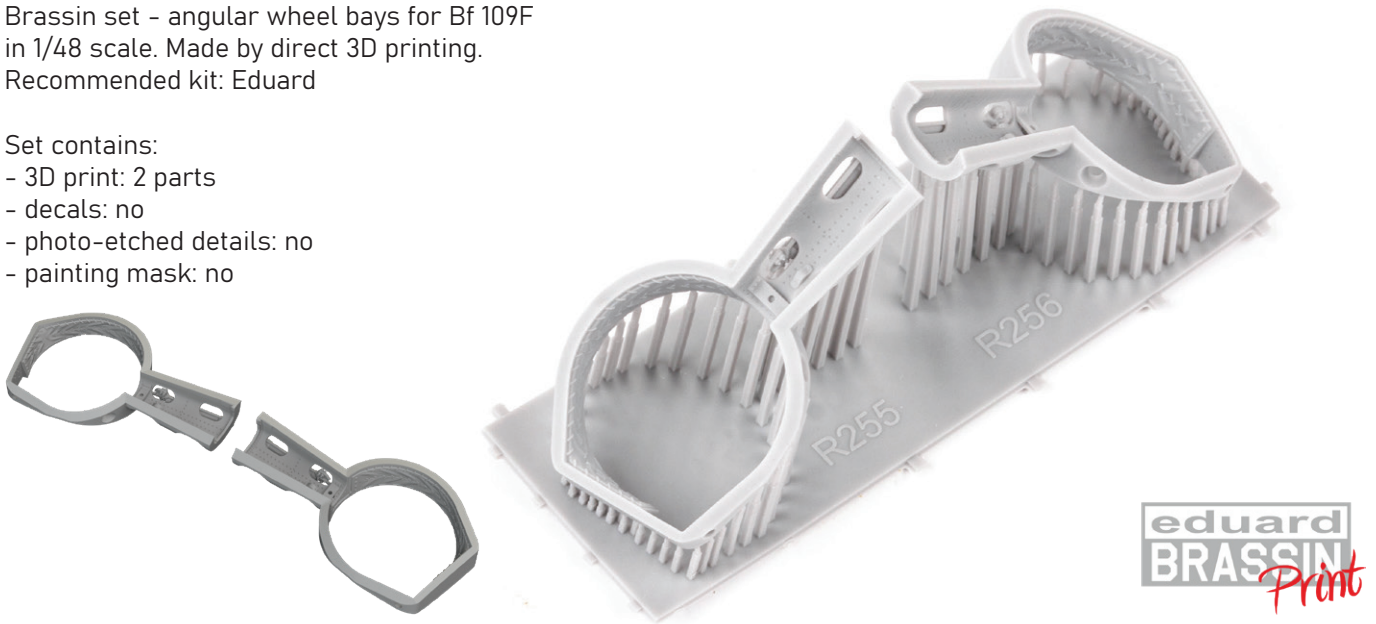

648882 F-4E wheels 1/48 Meng

Brassin set - the undercarriage wheels for F-4E in 1/48 scale. The set consists of the main wheels and nose wheels. Easy to assemble, replaces plastic parts. Recommended kit: Meng

Set contains:

- resin: 4 parts
- decals: no
- photo-etched details: no
- painting mask: yes

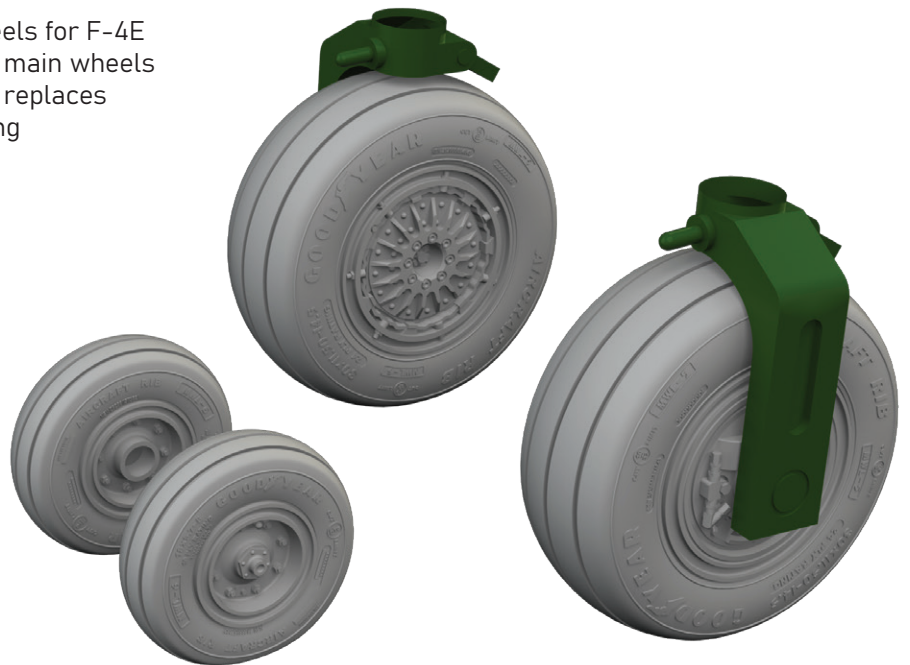

648883 A6M3 gun bays short barrel PRINT 1/48 Eduard

Brassin set - gun bays for A6M3 in 1/48 scale. Designed for Zeroes Type 32 and 22 with short-barreled wing guns (guns not protruding from the leading edge of the wing). Made by direct 3D printing. Recommended kit: Eduard

Set contains:

- 3D print: 22 parts
- decals: no
- photo-etched details: yes
- painting mask: no

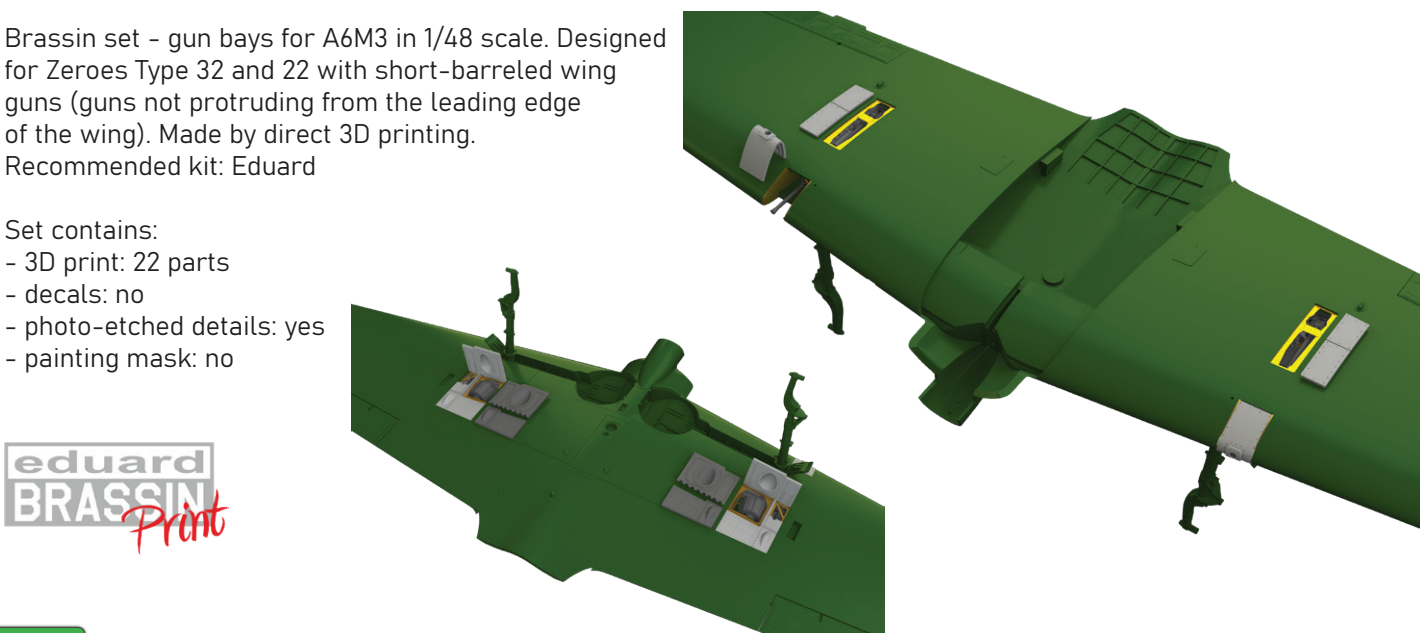

648886 FM-2 undercarriage legs BRONZE 1/48 Eduard

Brassin set - the undercarriage legs for FM-2 in 1/48 scale. The legs are made of bronze. Recommended kit: Eduard

Set contains:

- 3D print: 4 parts
- bronze: 2 parts
- decals: no
- photo-etched details: no
- painting mask: no

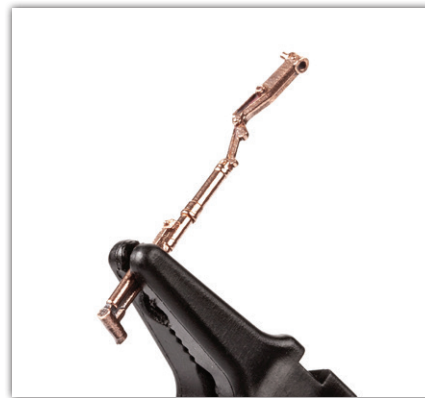
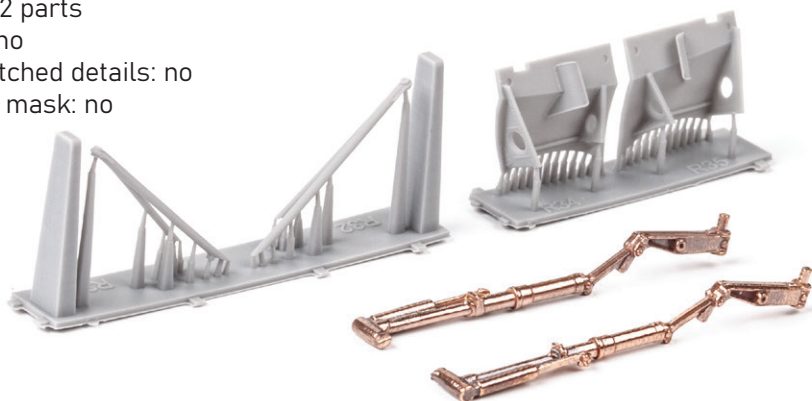

648887 FM-2 wheels 1/48 Eduard

Brassin set - the undercarriage wheels for FM-2 in 1/48 scale. The set consists of the main wheels and a tail wheel (5 options). Easy to assemble, replaces plastic parts. Recommended kit: Eduard

Set contains:

- resin: 9 parts
- decals: no
- photo-etched details: yes
- painting mask: yes

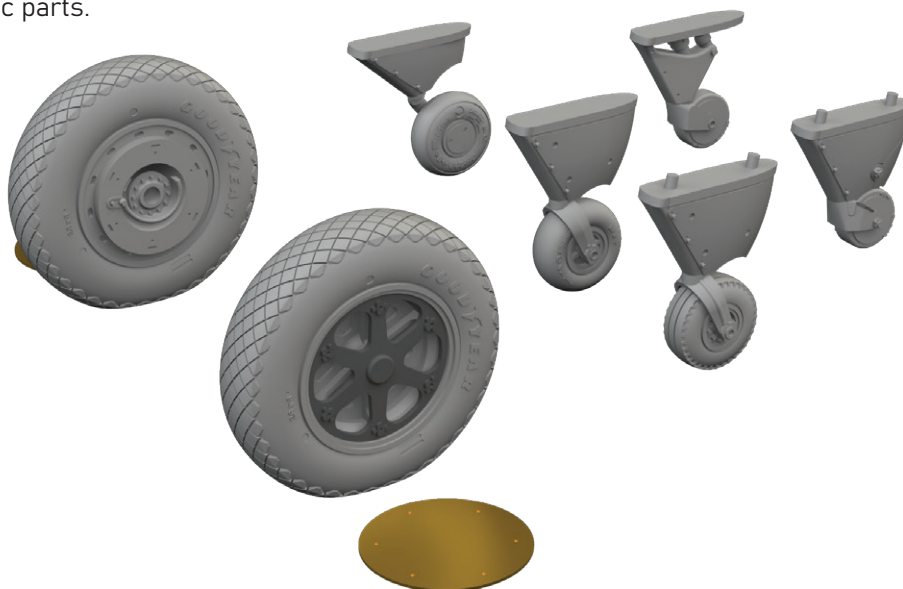

648888 FM-2 seat PRINT 1/48 Eduard

Brassin set - the seat for FM-2 in 1/48 scale. Made by direct 3D printing. Easy to assemble, replaces plastic parts. Recommended kit: Eduard

Set contains:

- 3D print: 1 part
- decals: no
- photo-etched details: yes, pre-painted
- painting mask: yes

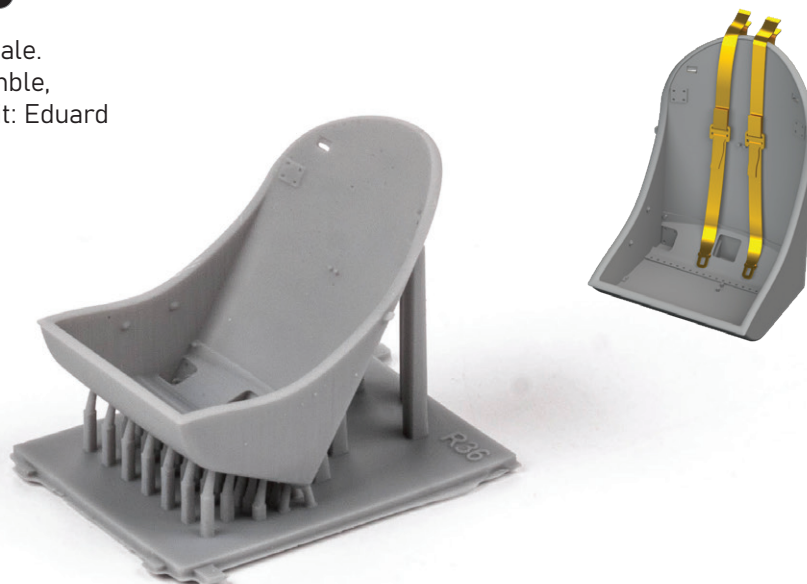

eduard
BRASSIN
Print

648889 FM-2 folding wings PRINT 1/48 Eduard

Brassin set - folding wings for FM-2 in 1/48 scale. The set consists of parts for both wings. Made by direct 3D printing. Recommended kit: Eduard

Set contains:

- 3D print: 10 parts
- plastic: 4 parts
- decals: no
- photo-etched details: yes
- painting mask: no

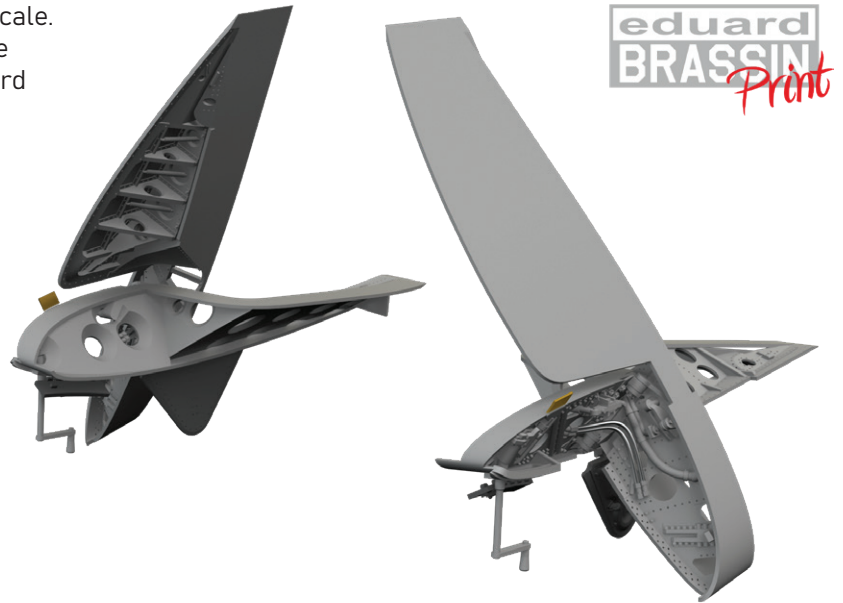
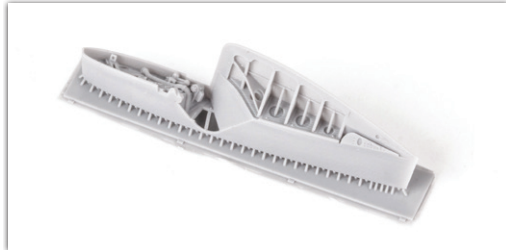

648890 FM-2 gun barrels PRINT 1/48 Eduard

Brassin set - gun barrels for FM-2 in 1/48 scale. Made by direct 3D printing. Recommended kit: Eduard

Set contains:

- 3D print: 4 parts
- decals: no
- photo-etched details: no
- painting mask: no

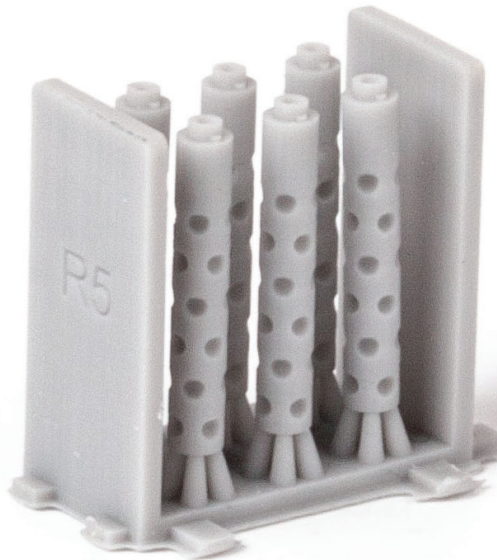

648891 F-104A/C airbrakes PRINT 1/48 Kinetic/Eduard

Brassin set - airbrakes for F-104A/C in 1/48 scale. Made by direct 3D printing. Recommended kit: Kinetic/Eduard

Set contains:

- 3D print: 2 parts
- decals: no
- photo-etched details: no
- painting mask: no

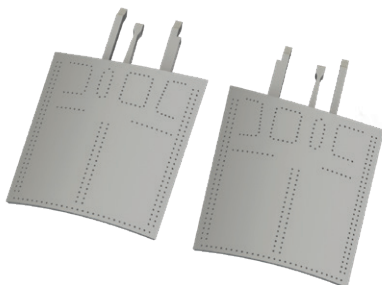

648892 F-104A/C exhaust nozzle PRINT 1/48 Kinetic/Eduard

Brassin set - exhaust nozzle for F-104A/C in 1/48 scale.
Made by direct 3D printing. Easy to assemble, replaces plastic parts. Recommended kit: Kinetic/Eduard



Set contains:

- 3D print: 4 parts
- decals: no
- photo-etched details: no
- painting mask: no



648895 FM-2 cockpit PRINT 1/48 Eduard

Brassin set - cockpit for FM-2 in 1/48 scale.
Made by direct 3D printing. Recommended kit: Eduard



Set contains:

- 3D print: 1 parts
- decals: yes
- photo-etched details: yes, pre-painted
- painting mask: no
- SPACE 3D decals: no

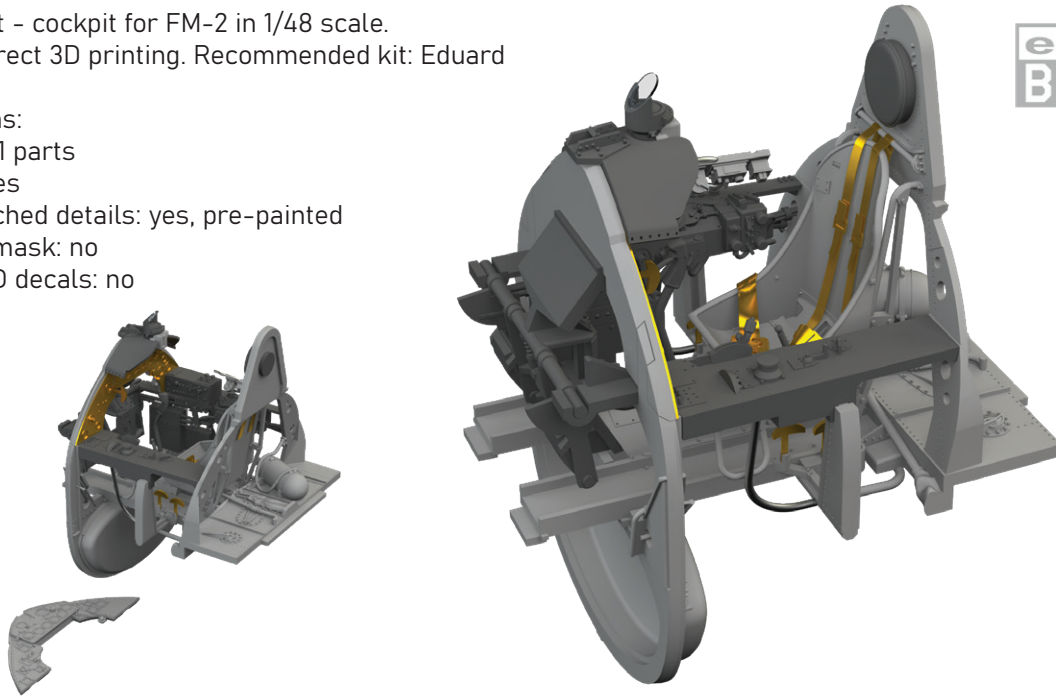

672317 Bf 109F undercarriage legs BRONZE 1/72 Eduard

Brassin set - the undercarriage legs for Bf 109F in 1/72 scale. The legs are made of bronze.
Recommended kit: Eduard

Set contains:

- 3D print: 2 parts
- bronze: 2 parts
- decals: no
- photo-etched details: no
- painting mask: no



672326 Bf 109F/G/K gun pods PRINT 1/72 Eduard

Brassin set - gun pods for Bf 109F/G/K in 1/72 scale. Easy to assemble, replaces plastic parts. Made by direct 3D printing. Recommended kit: Eduard

Set contains:

- 3D print: 8 parts
- decals: no
- photo-etched details: yes
- painting mask: no

eduard
BRASSIN
Print

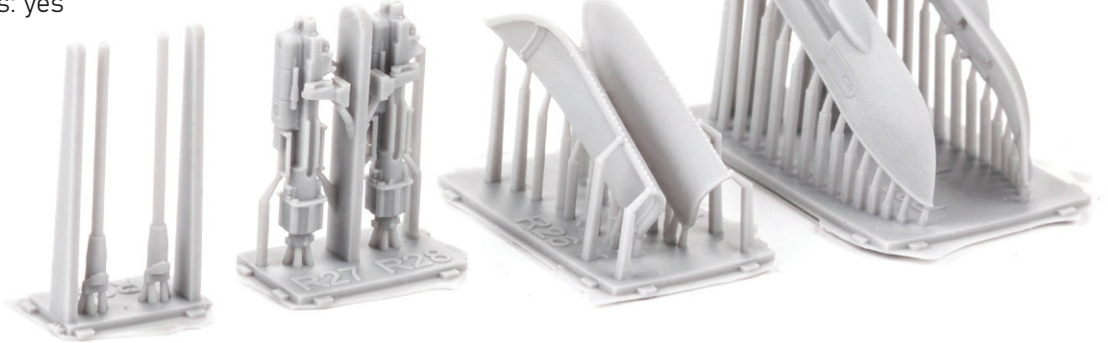

672329 Bf 109 balance weights PRINT 1/72 Eduard

Brassin set - wing balance weights for Bf 109F in 1/72 scale. The set consists of 10 balance weights. Easy to assemble, replaces plastic parts. Made by direct 3D printing. Recommended kit: Eduard

Set contains:

- 3D print: 10 parts
- decals: no
- photo-etched details: no
- painting mask: no

eduard
BRASSIN
Print



672330 MiG-29 wheels 1/72 Great Wall Hobby

Brassin set - the undercarriage wheels for MiG-29 in 1/72 scale. The set consists of the main wheels and nose wheels. Easy to assemble, replaces plastic parts. Recommended kit: Great Wall Hobby

Set contains:

- resin: 4 parts
- 3D print: 1 part
- decals: no
- photo-etched details: no
- painting mask: yes



634040 Spitfire Mk.Ia LööKplus 1/32 Kotare

Collection of 4 sets for Spitfire Mk.Ia in 1/32 scale.
Recommended kit: Kotare

- LööK set (pre-painted Brassin dashboards & Steelbelts)
- TFace painting mask
- undercarriage wheels
- exhaust stacks

LööK

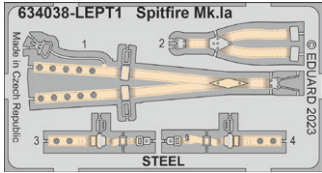

644221 Do 335A LööKplus 1/48 Tamiya

Collection of 4 sets for Do 335A in 1/48 scale.
Recommended kit: Tamiya

- LööK set (pre-painted Brassin dashboards & Steelbelts)
- TFace painting mask
- undercarriage wheels
- exhaust stacks

Löökt

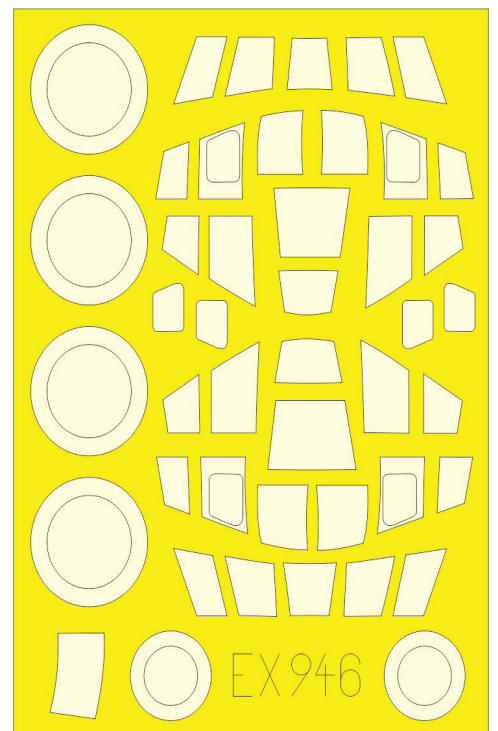
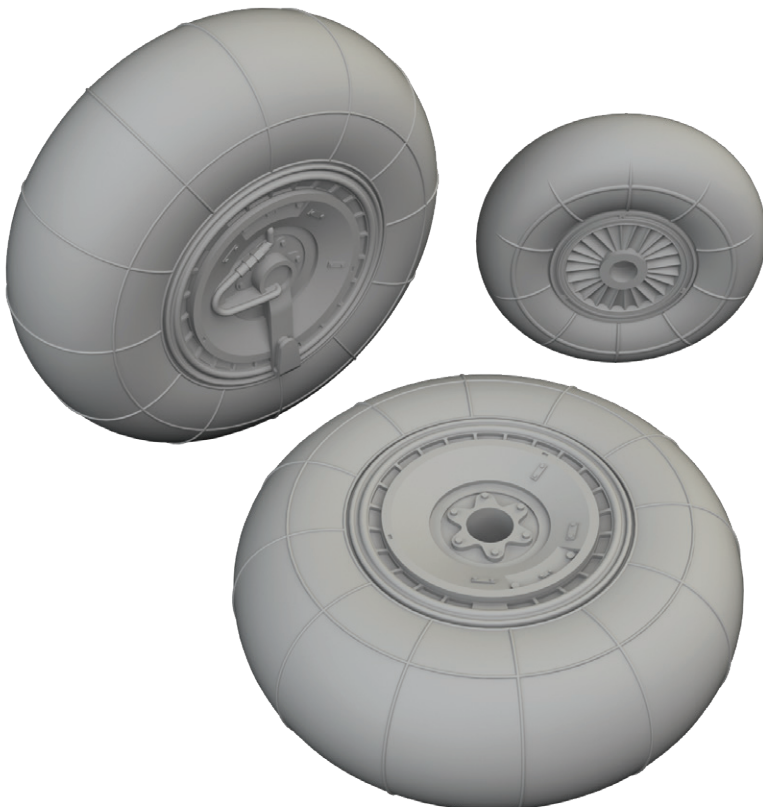
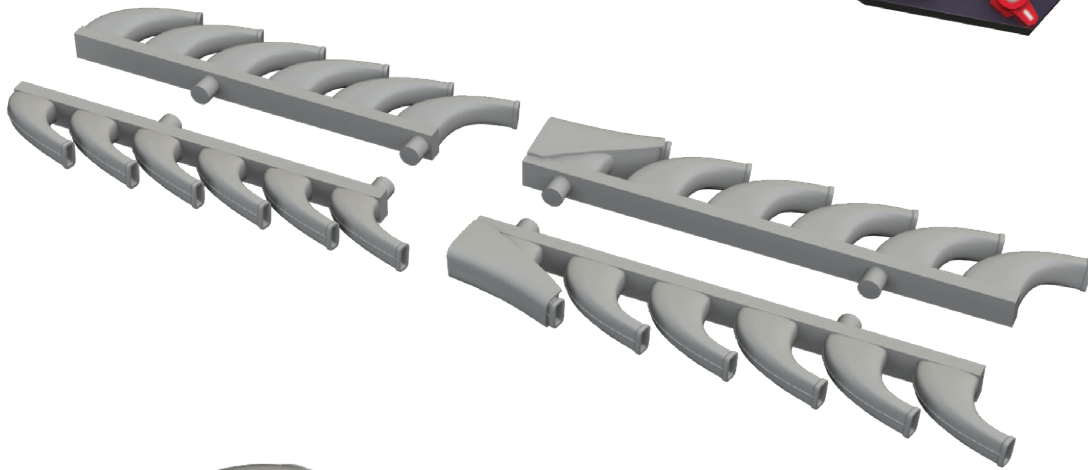
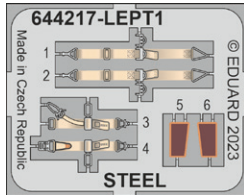

SIN648109 F-4E armament 1/48 Meng

Collection of 7 sets for F-4E in 1/48 scale.
Recommended kit: Meng

- AGM-65 Maverick (3 sets)
- AIM-7M Sparrow
- AN/ALQ-131 (shallow) ECM pod
- GBU-10 Paveway I
- AIM-9M/L Sidewinder

All sets included in this BIG SIN are available separately,
but with every BIG SIN set you save up to 30 %.

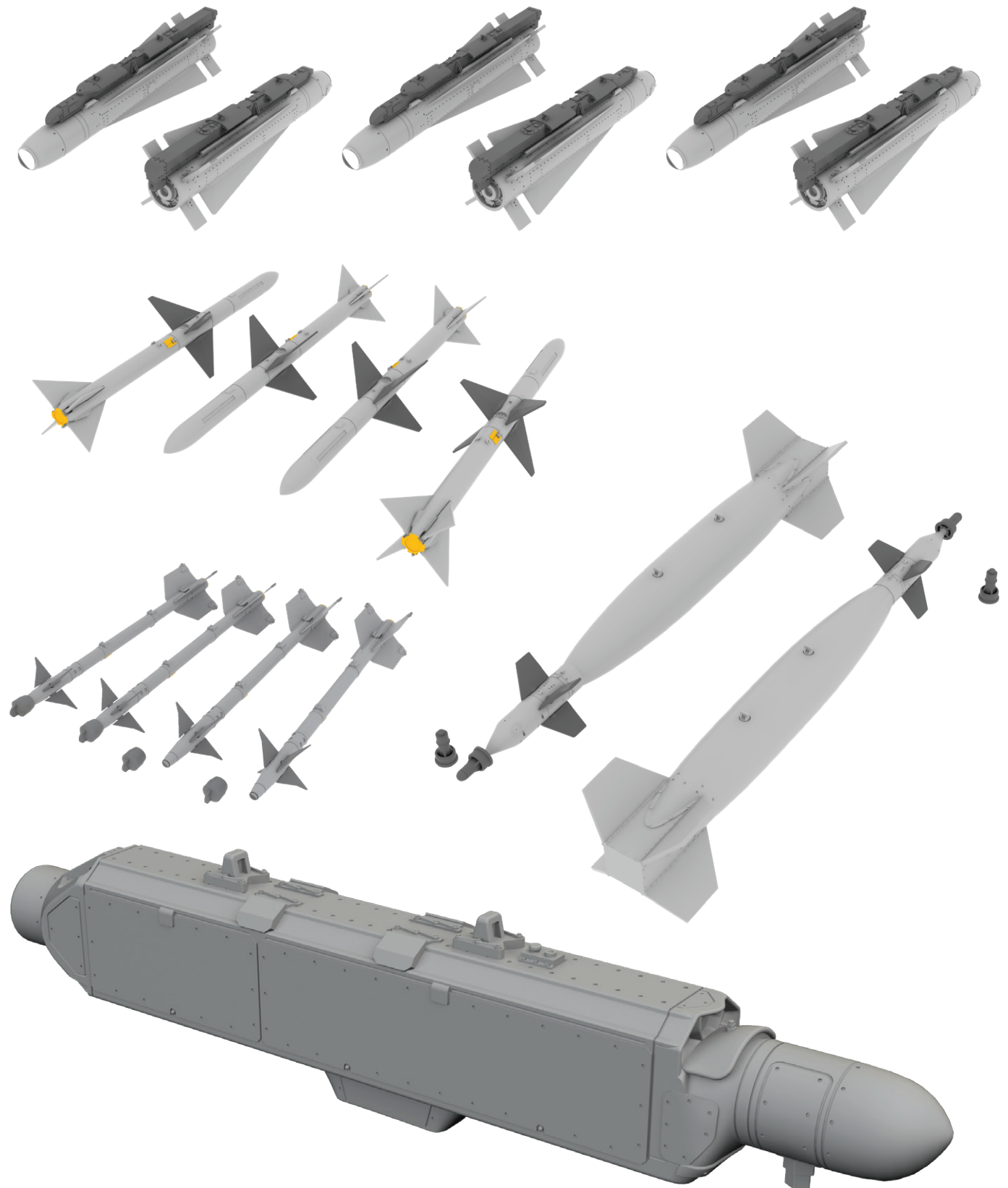

BIG33152 CH-54A 1/35 ICM

- 321008 CH-54A 1/35
- 32482 CH-54A exterior 1/35
- 33348 CH-54A seatbelts STEEL 1/35
- JX307 CH-54A 1/35

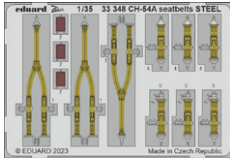
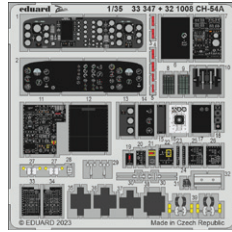
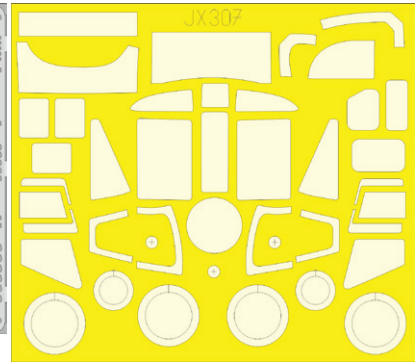
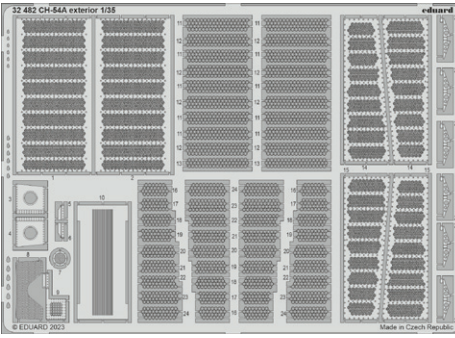
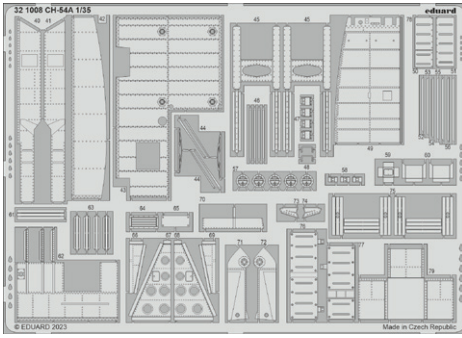

BIG49373 B-24D PART II 1/48 Revell

- 481102 B-24D exterior 1/48
- 481104 B-24D bomb bay 1/48
- 491339 B-24D nose interior 1/48

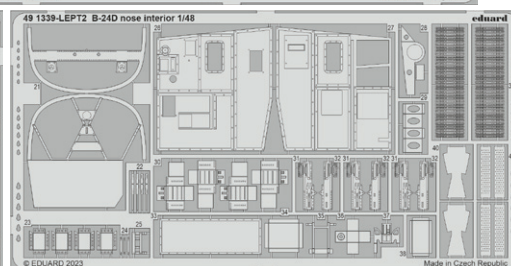
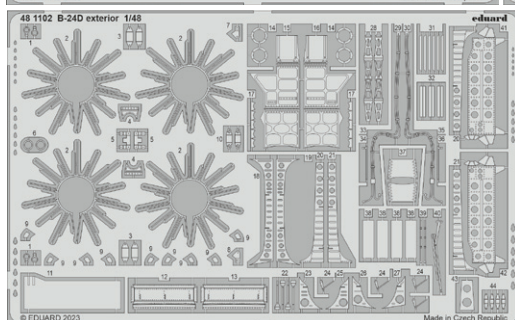
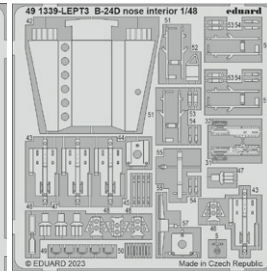
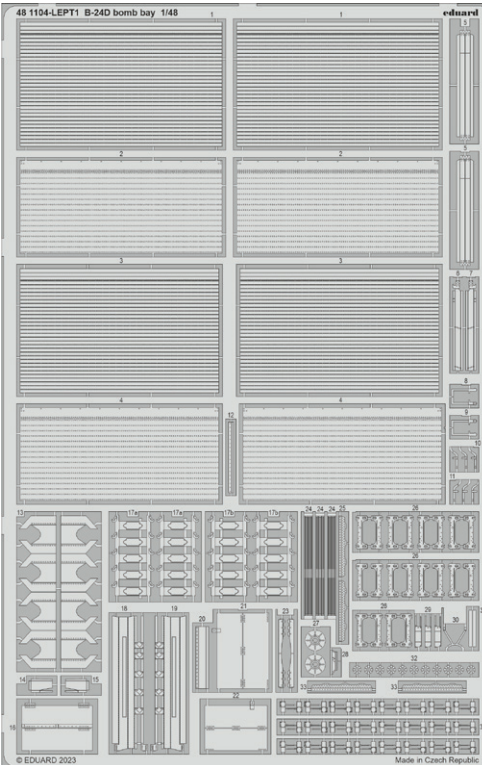
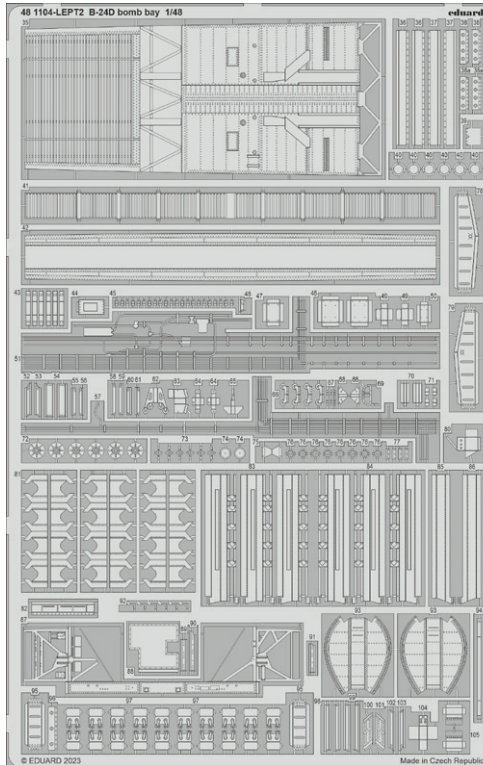

BIG49374 Mi-17 1/48 AMK

- 481110 Mi-17 cargo floor 1/48
- 491352 Mi-17 1/48
- 491353 Mi-17 cargo seatbelts 1/48
- FE1353 Mi-17 seatbelts STEEL 1/48
- EX942 Mi-17 1/48

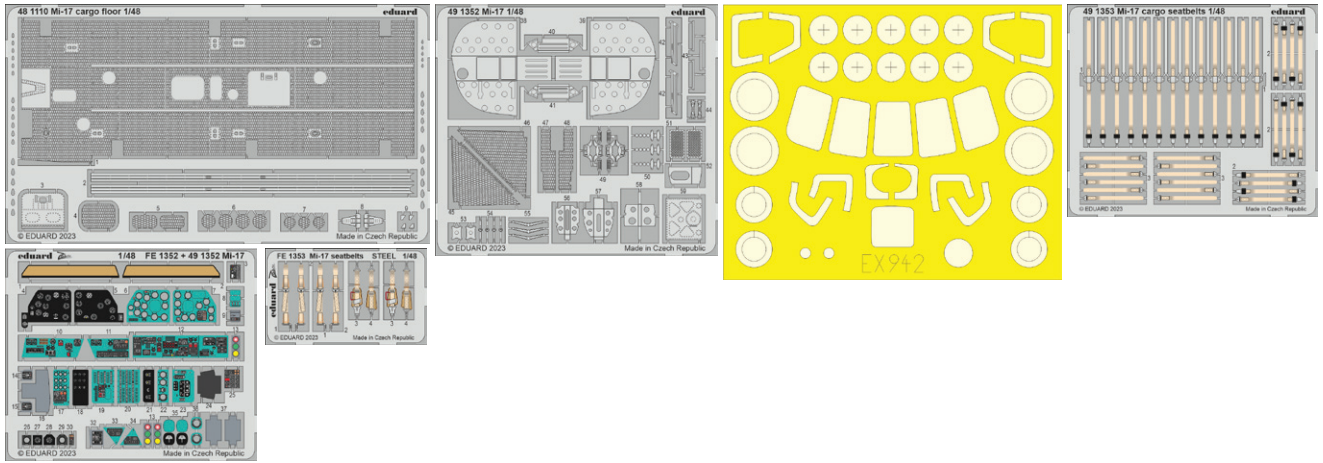

BIG49375 F-86D 1/48 Revell

- 491350 F-86D 1/48
- FE1351 F-86D seatbelts STEEL 1/48
- EX940 F-86D 1/48

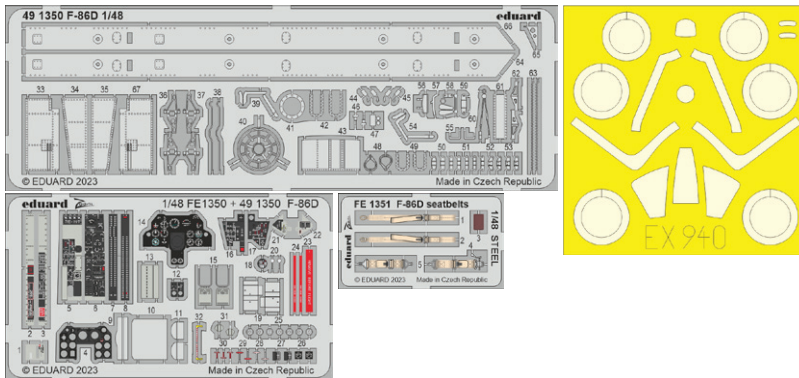

BIG49376 PV-1 PART I 1/48 Academy

- 491348 PV-1 1/48
- FE1349 PV-1 seatbelts STEEL 1/48
- EX944 PV-1 1/48

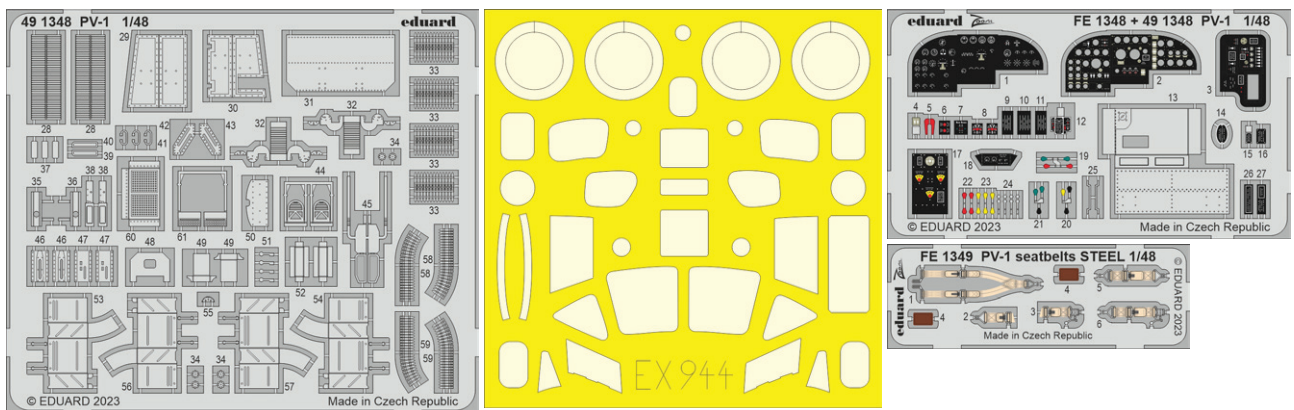



JULY 2023

SIN648107
A6M2-N Rufe
1/48 Eduard



Collection of 4 sets for A6M2-N in 1/48 scale.
Recommended kit: Eduard

- engine
- gun bays
- landing flaps
- cockpit

All sets included in this BIG SIN are available separately,
but with every BIG SIN set you save up to 30 %.

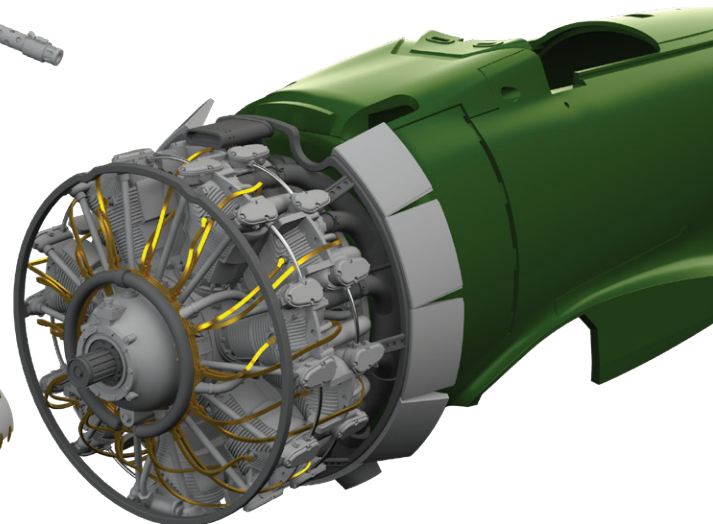
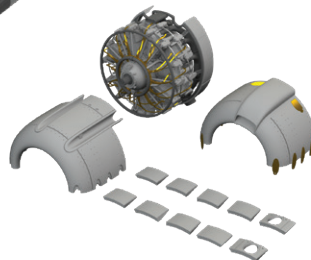
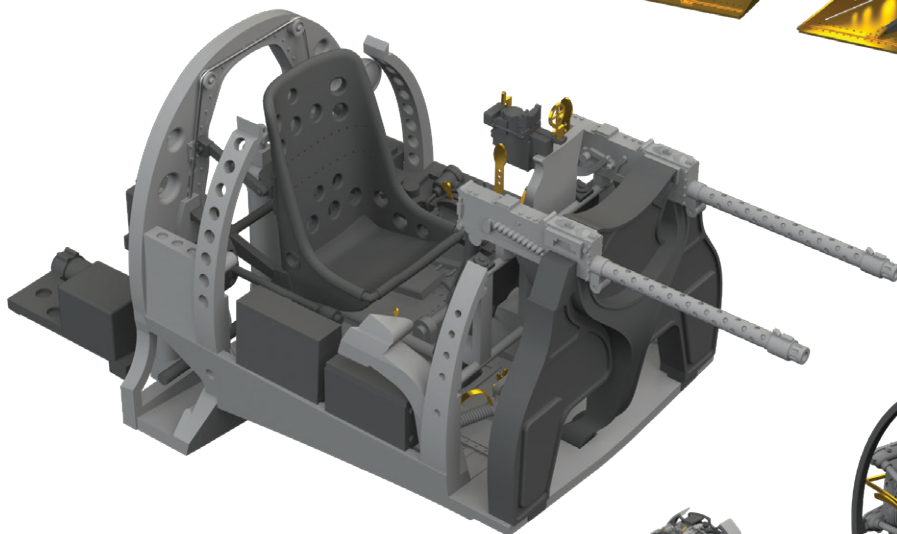
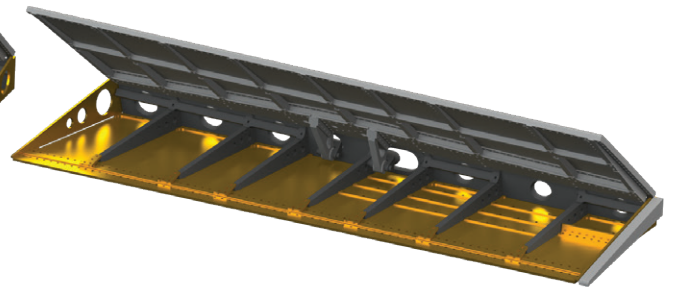
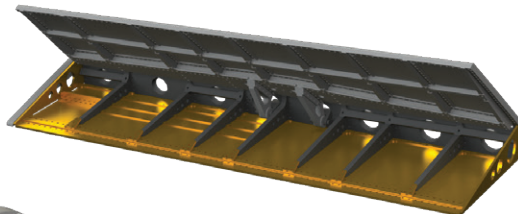
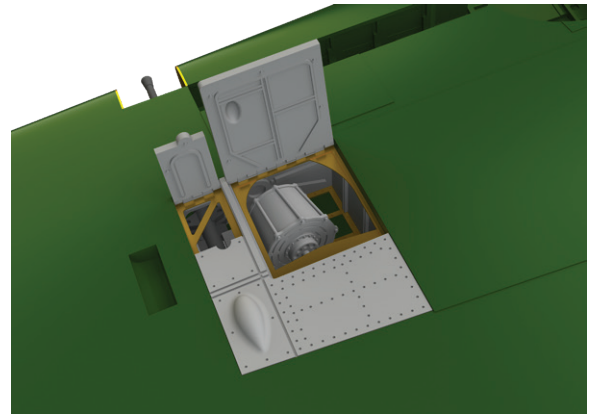
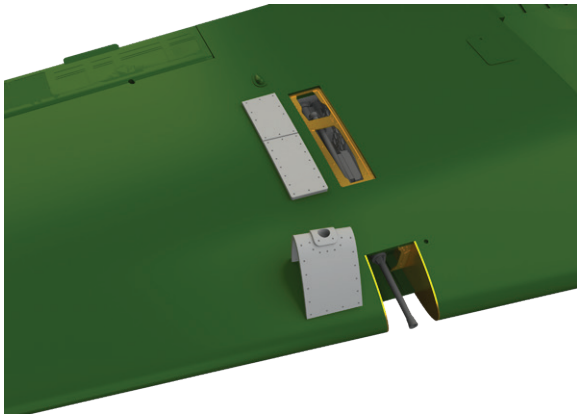
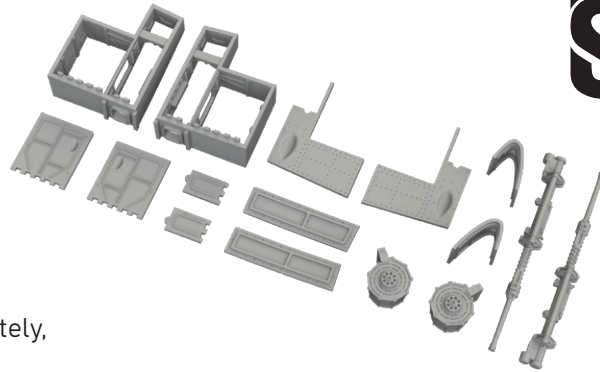

#648876 Bf 109F cockpit PRINT

1/48 Eduard



Brassin set - cockpit for Bf 109F in 1/48 scale.
Made by direct 3D printing.
Recommended kit: Eduard

Set contains:

- 3D print: 16 parts
- resin: 1 part
- decals: yes
- photo-etched details: yes, pre-painted
- painting mask: no
- SPACE 3D decals: no

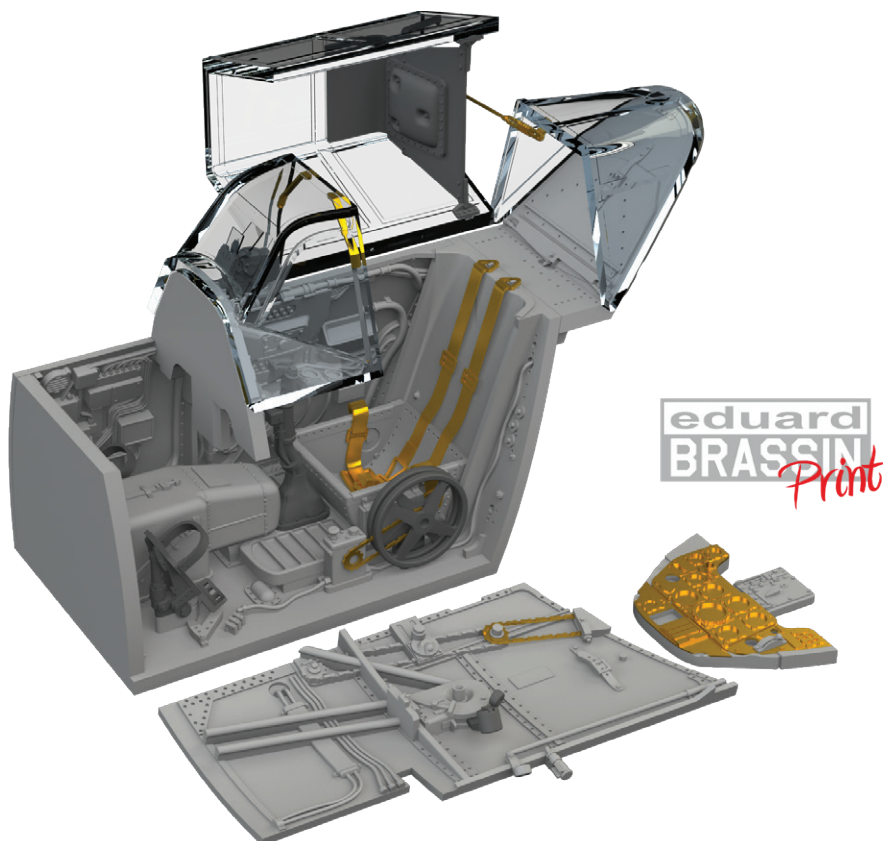

#648866 Anson Mk.I engines PRINT

1/48 Airfix

Brassin set - two engines for Anson Mk.I
in 1/48 scale. The cowlings are not included.
Made by direct 3D printing.
Recommended kit: Airfix

Set contains:

- 3D print: 6 parts
- decals: no
- photo-etched details: yes
- painting mask: no

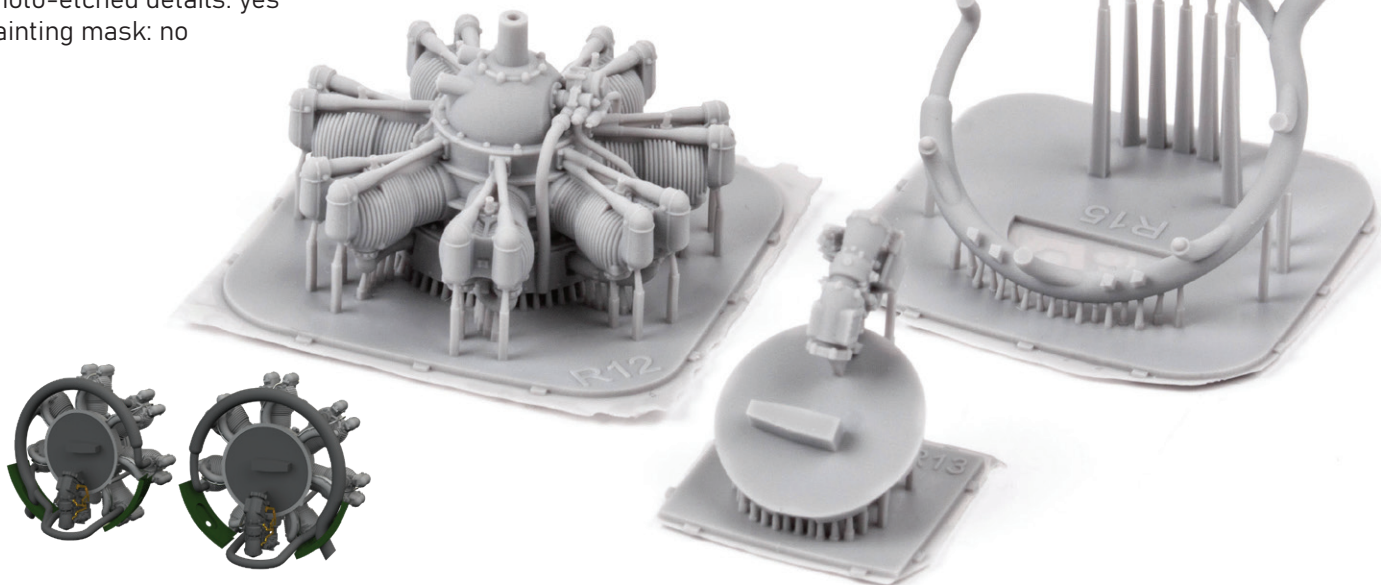
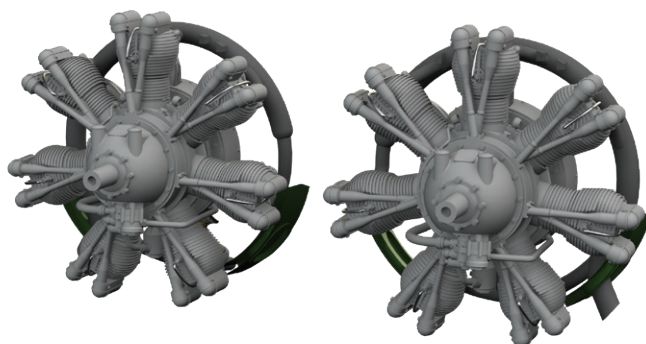

#648872

P-51D/K radiator PRINT

1/48 Eduard



Brassin set - the radiator for P-51D/K
in 1/48 scale. Made by direct 3D printing.
Recommended kit: Eduard

Set contains:

- 3D print: 2 parts
- decals: no
- photo-etched details: no
- painting mask: no

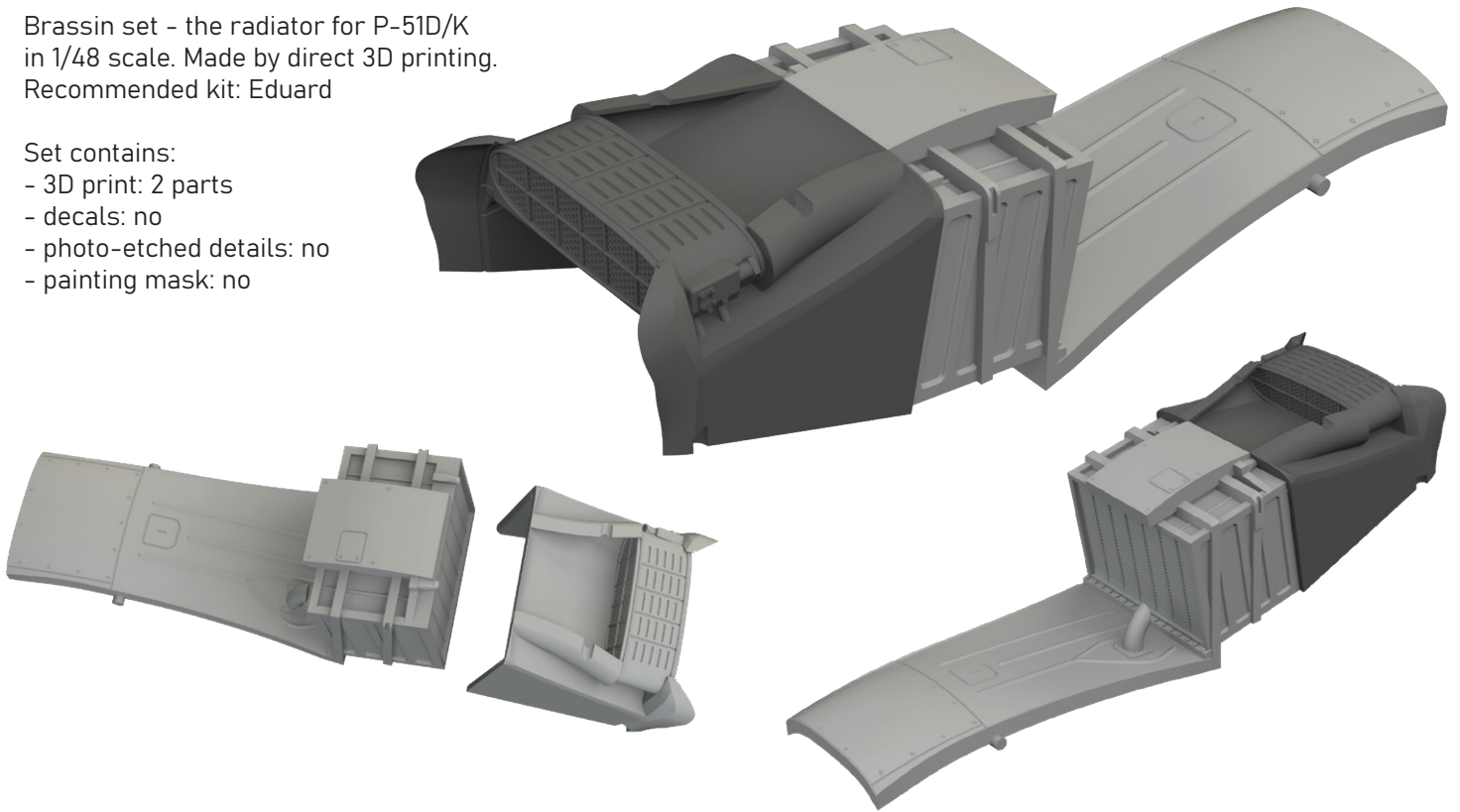

#3DL32018

F-35A SPACE

1/32 Trumpeter

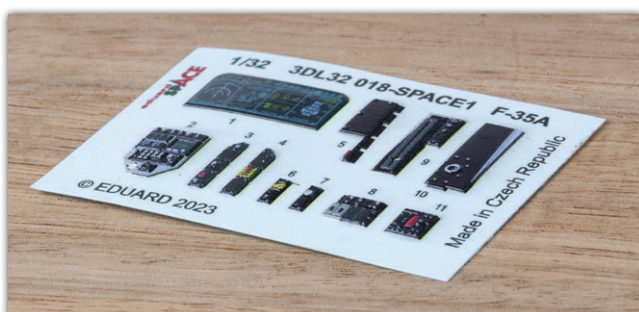
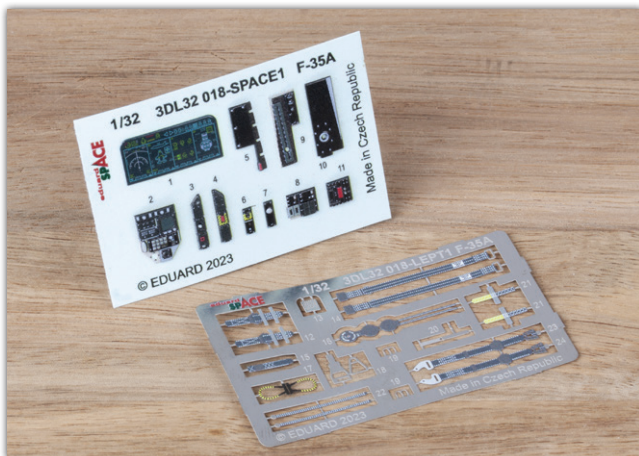

#3DL32019

A-20G SPACE

1/32 HKM

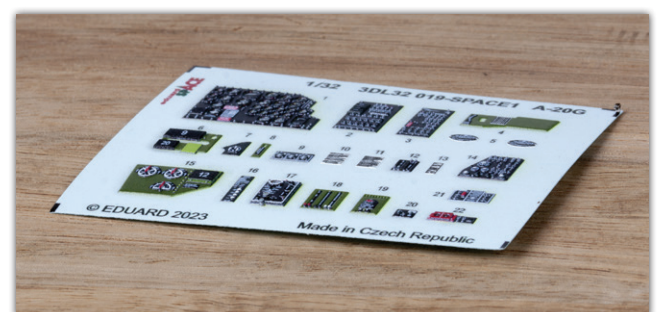
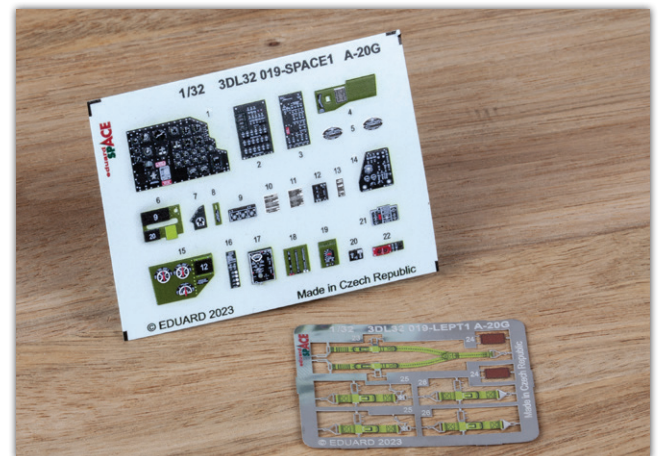



Bf 110G-4 1/48

The Weekend edition kit of German WWII twin-engine heavy fighter aircraft Bf 110G-4 in 1/48 scale. This version was used in night fighter role with three crew.

WEEKEND
edition

WILD CARDS 

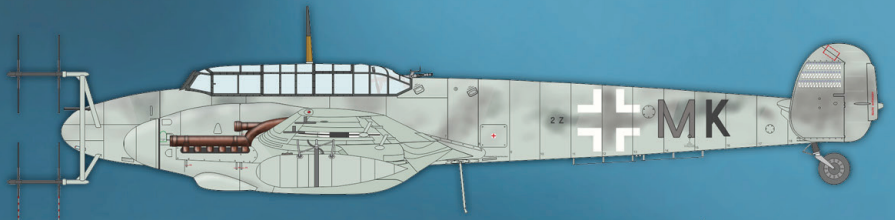

Oblt. Martin Becker, 2./NJG 6,
Florennes, Belgium, May 1944

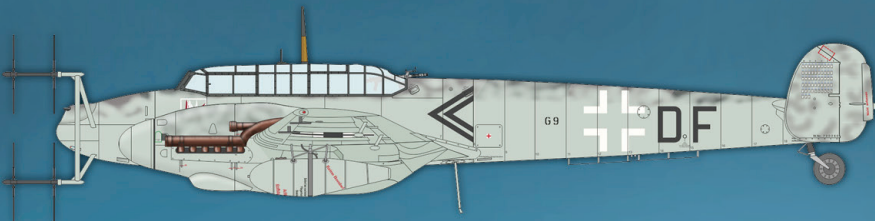

WNR. 720260, Oblt. Heinz-Wolfgang Schnauffer,
CO of IV./NJG 1, Sint Truiden, Belgium, April 1944

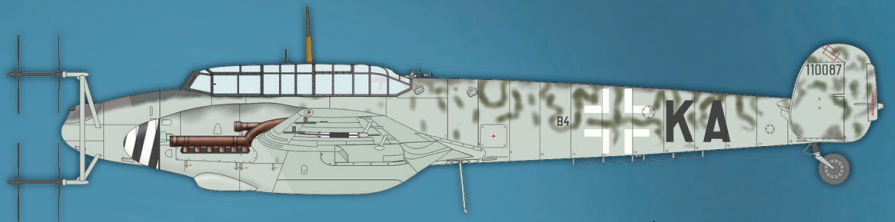

WNR. 110 087, 4./NJG 3, Kjevik,
Norway, 1945

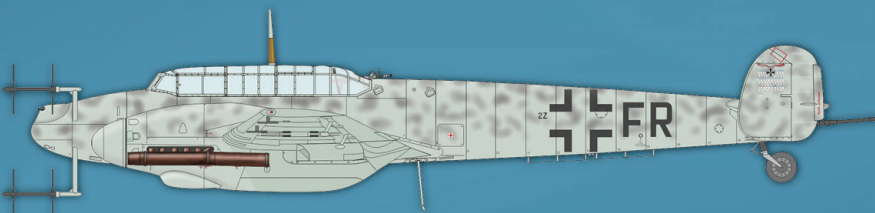

Hptm. Wilhelm Johnen, CO of III./NJG 6,
Neubiberg, Germany, 1945

#8405

www.eduard.com