

INFORMATION FOR DISTRIBUTORS

JUNE 2023

Dear friends,
In today's Leaflet you will find the upcoming releases for June 2023.

THE KITS

In June we will release four new kits as new items and one more that was released earlier and not available for some time.

The most awaited kit is WUNDERSCHÖNE NEUE MASCHINEN part 1, is the 1/72 scale Limited Edition Dual Combo, dedicated to Messerschmitt Bf 109F-2 and F-4. The kit includes two sets of frames, containing two fuselage versions and three wing versions, used on different developmental variants of the Bf 109F-1, F-2 and F-4. The kit offers 14 decal options, one F-1, six F-2 and seven F-4, including tropical and fighter-bomber versions. The selection is full of famous names such as Mölders, Priller, Nowotny, Marseille, Bär, Graf and others. The design of this kit is a direct follow-up to the 1/725 scale Avia S-199 released last year. It will be followed by other parts of this extensive project in the following months: in September will be released WUNDERSCHÖNE NEUE MASCHINEN Volume 2, dedicated to the Bf 109G-2 and G-4, in October will follow ProfiPACK Bf 109F-2, in December will be released Bf 109F-4. After the New Year, we will continue with a Limited Editions dedicated to the Bf 109G-6 and G-14 and other ProfiPACKs. Weekend editions will be added during the same year, as well as Limited Editions dedicated to the Bf 109G-6/AS and G-14/AS, and later on the G-10. We will conclude the project in following year with the release of the Bf 109K-4.

In the ProfiPACK edition we are releasing two kits in June. The first one is a British WW1 Sopwith 2F.1 Camel fighter aircraft in 1/48 scale. This naval version of the legendary British fighter plane was modified for takeoffs from platforms mounted on the turrets of large warships or from the decks of early aircraft carriers. The split folding fuselage made it easy to store the aircraft on the decks. The kit offers six marking options, including the machine that took part in the famous raid on the Zeppelin base, or the Camel that joined the fight against the Bolsheviks in 1919.

The second kit in the ProfiPACK edition is a re-release of the 1/48 Messerschmitt Bf 109G-6 in late version. We have not changed anything about its content, from the decal sheet it will be possible to build one of the five machines, including the personal mounts of Hermann Graf and Anton Hafner. We have also not changed the box art by the famous Shigeo Koike.

In the Weekend edition we are also releasing two 1/48 scale kits. Tempest Mk.II will offer two RAF machines and one each Indian and Pakistani aircraft.

The second kit in the Weekend series, the A6M2 Zero

Type 21, is one of the highlights of the June releases. Its boxart takes us back to the very beginning of the Pacific War, the raid on Pearl Harbor, with the famous scene of the attack by fighters from the aircraft carrier Akagi on the landing B-17 crew of Capt. Swenson on Hickam Field. The kit will offer decals for four machines. In addition to the aircraft from the Akagi carrier, it will include a machine from the fighting in present-day Indonesia from the 3rd Kōkūtai, a Zero from Kōkūtai 261 based at Saipan, and a very interesting and unusual Kōkūtai 302 night fighter from the summer of 1945 with black undersurfaces.

BRASSIN

In June we are releasing a detailed cockpit set for Tamiya's new 1/48 scale F-35A, of course made by direct 3D printing. It's ready for virtually seamless insertion into the fuselage.

For the 1/48 scale Wildcat (Eduard), another engine set with engine cowlings is included, this time it will be a set for the so-called mid version. In connection with the re-release of the kit Bf 109G-6 late (Eduard), we have prepared a new cockpit set, based on the design of the original resin cast set, but reworked into a direct 3D print. We have redesigned the interior set for the Fw 190F-8 fighter in the same way. I'd like to point out that this is a big improvement in terms of the user comfort of accessory sets. Especially for the Bf 109G, this step eliminates some flaws in the fitting of the original set with the plastic parts, resulting from the lack of dimensional stability of the resin castings. We will of course gradually release accessories for the new 1/72 scale Bf 109F (Eduard). In June we start with sets for propeller, wheel and weapons.

A weapon set is also included in the June collection for the 1/48th scale naval Camel 2F.1 (Eduard), and a pre-painted radio set is included for another Eduard kit in the same scale, the Bf 110G. We are releasing engines (without engine cowlings) for the B-25J in 1/48 by HKM, and for the Mi-8MT (Zvezda) and Mi-17 (AMK) helicopter kits in 1/48, we have prepared the wheel sets. We are also releasing landing gear wheels for the new Spitfire Mk.IXc in 1/24 scale by Airfix.

Among our generic sets we will add a ladder for the F-16 fighter in 1/48 scale, as well as additional magazines for Lewis machine guns and four sets of equipment for German WWII combat vehicles in 1/35 scale.

SPACE

The June offer includes a total of eight items in the Space range. In 1/32 scale it is a set for Spitfire Mk.I (Kotare), in 1/35 scale for AH-64E (Takom). In 1/48

scale are sets for PV-1 (Academy), Dornier Do 335A Pfeil (Tamiya reissue), as well as a set for Mi-8MT helicopter kit (Trumpeter) and F-4E (Meng). A 1/72 scale set for Eduard's new Bf 109F and MiG-29 is available from Great Wall Hobby.

Photo-etched parts

For Kotare's Spitfire Mk.I we are releasing a Zoom set, STEEL belts, a large photo-etched set and flaps, other sets are intended for the new kits MiG-29 9-12 (1/72, GWH), AH-64E (1/35, Takom) and F-4E (1/48, Meng).

Tamiya has re-released a 1/48 scale Do 335A Pfeil, following this welcome development our designers have reworked the photo-etched sets we previously produced for this kit. So in June we are releasing the Zoom set, the STEEL belts and the large photo-etched set in a new design. For July we have prepared a set for Do 335A bomb bay.

Back to June, we also have a set for the Mi-8MT in 1/48 scale from Trumpeter. This is a similar set of parts to the Mi-8/17, especially the seats for the cargo area, which are missing in the kit.

In the combat vehicle kit segment we will focus on the Scammel Commander with trailer in 1/35 scale by Hobby Boss. The pre-painted photo-etched set includes lights, reflectors, seat belts and dashboard. Another photo-etched set will be produced for the 1/35th scale M3A4 Sherman by I love kits, and of course we can't leave out the new 1/35th scale Panzer IV/70 (A) by Tamiya.

And in June, we'll follow up with a third set for the 1/350th scale USS Missouri (BB-63) battleship kit from Hobby Boss.

Orders

We would welcome your pre-orders for June items by Monday, May 1, 2023. Thank you!

May items will be ready for shipping on Tuesday, 18 April.

In connection with the Moson Show, which will be held in Hungary on 22 and 23 April 2023, our e-shop will be running a traditional discount event for retail customers.

We are also sending folder with the graphics included in the Leaflet. Many of you are using our Leaflet images for pre-order section of your e-shops and in your newsletters. We hope this will save you some time.

If you would like get more information, clarify some points or if you would need our help, please contact us at [department@](mailto:department@eduard.com) or contact me directly at jan.bobek@eduard.cz

Jan Bobek

Product previews are subject of change.

Instruction sheets,
more pictures and information
can be found on www.eduard.com

This leaflet can be downloaded from on www.eduard.com

eduard

PLASTIC KITS



82173 **Sopwith 2F.1 Camel**
1/48 ProfiPACK

DETAIL



2142 **WUNDERSCHÖNE NEUE MASCHINEN pt. 1**
1/72 Limited **DUAL COMBO**

DETAIL

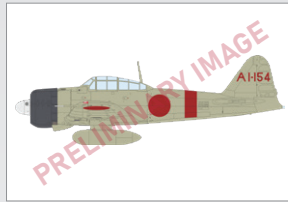

84189 **A6M2 Zero Type 21**
1/48 Weekend edition

DETAIL



84190 **Tempest Mk.II**
1/48 Weekend edition

DETAIL



82111 **Bf 109G-6 late series**
1/48 ProfiPACK **Re-release**

DETAIL

MASKS

JX309	Spitfire Mk.I	1/32	Kotare
JX310	Spitfire Mk.I TFace	1/32	Kotare
JX311	AH-64E	1/35	Takom
JX312	AH-64E TFace	1/35	Takom
EX947	Mi-8MT	1/48	Trumpeter
EX948	Mi-8MT TFace	1/48	Trumpeter
EX949	F-4E	1/48	Meng
EX950	F-4E TFace	1/48	Meng
EX951	A6M2 Zero Type 21 Weekend	1/48	Eduard
EX952	Tempest Mk.II Weekend	1/48	Eduard
CX648	MiG-29 9-12	1/72	Great Wall Hobby

SPACE

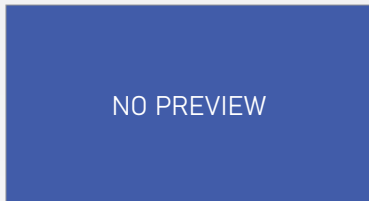

3DL32016 Spitfire Mk.I SPACE
1/32 Kotare
(2 parts)

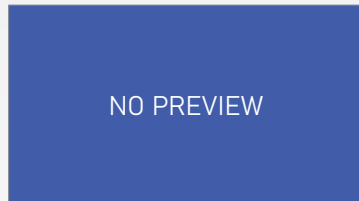

3DL32017 AH-64E SPACE
1/35 Takom
(2 parts)

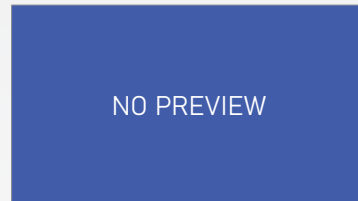

3DL48120 PV-1 SPACE
1/48 Academy
(2 parts)

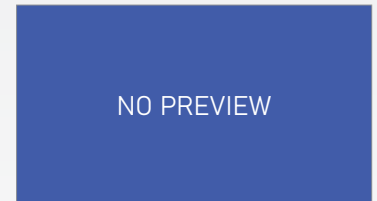

3DL48121 Do 335A SPACE
1/48 Tamiya
(2 parts)

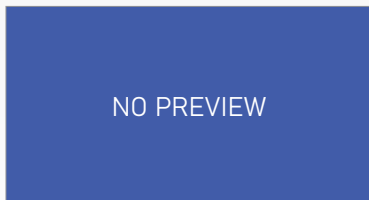

3DL48122 Mi-8MT SPACE
1/48 Trumpeter
(2 parts)

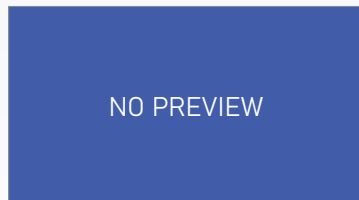

3DL48123 F-4E SPACE
1/48 Meng
(2 parts)

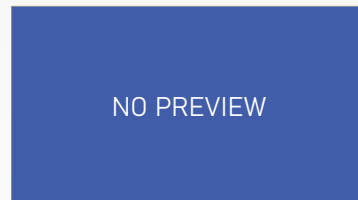

3DL72017 MiG-29 9-12 SPACE
1/72 Great Wall Hobby
(2 parts)

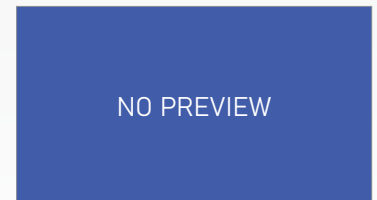

3DL72018 Bf 109F SPACE
1/72 Eduard
(2 parts)

PHOTO-ETCHED SETS



53294 USS Missouri BB-63 part 3
1/350 Hobby Boss
(1 part)

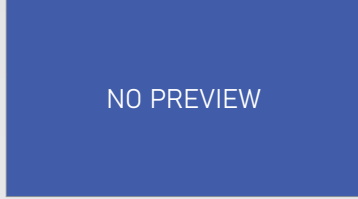

32483 Spitfire Mk.I landing flaps
1/32 Kotare
(1 part)

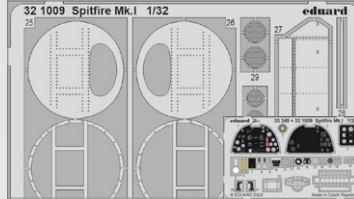

321009 Spitfire Mk.I
1/32 Kotare
(2 parts)

DETAIL

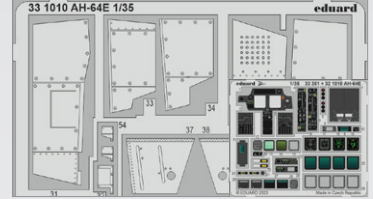

321010 AH-64E
1/35 Takom
(2 parts)

DETAIL

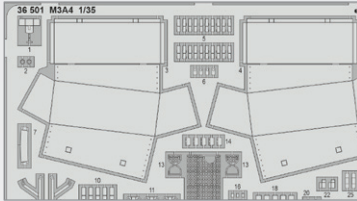

36501 M3A4
1/35 I Love Kits
(1 part)

DETAIL

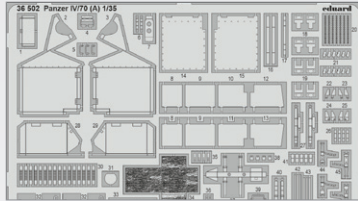

36502 Panzer IV/70 (A)
1/35 Tamiya
(1 part)

DETAIL

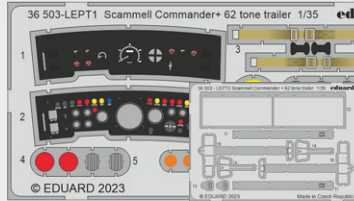

36503 Scammell Commander w/ 62t
semitrailer 1/35 Hobby Boss
(2 parts)

DETAIL

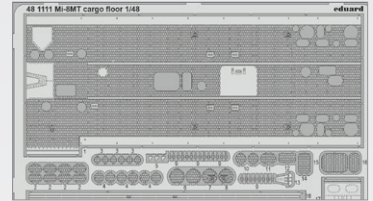

48111 Mi-8MT cargo floor
1/48 Trumpeter
(1 part)

DETAIL

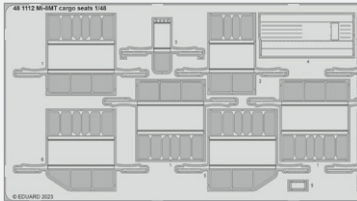

48112 Mi-8MT cargo seats
1/48 Trumpeter
(1 part)

DETAIL

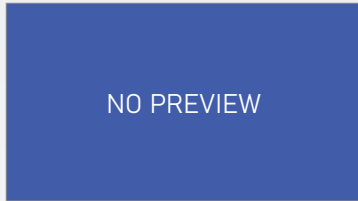

491354 Do 335A
1/48 Tamiya
(2 parts)

DETAIL

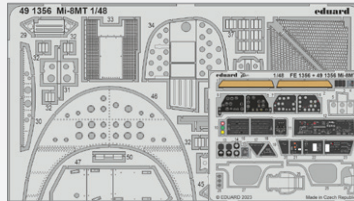

491356 Mi-8MT
1/48 Trumpeter
(2 parts)

DETAIL

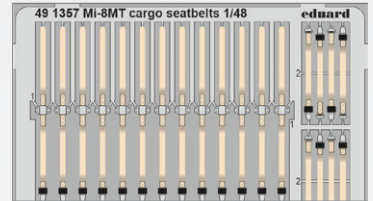

491357 Mi-8MT cargo seatbelts
STEEL 1/48 Trumpeter
(1 part)

DETAIL

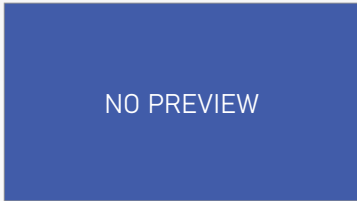

491358 F-4E
1/48 Meng
(2 parts)

DETAIL

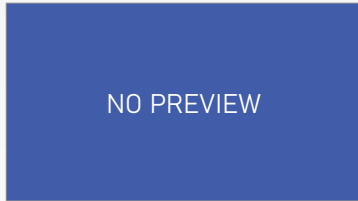

73802 MiG-29 9-12
1/72 Great Wall Hobby
(1 part)

DETAIL

PHOTO-ETCHED SETS

ZOOM

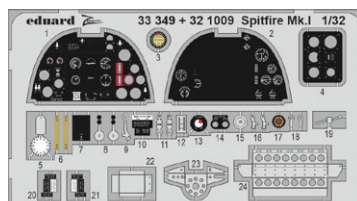

33349 Spitfire Mk.I
1/32 Kotare
(1 part)

DETAIL

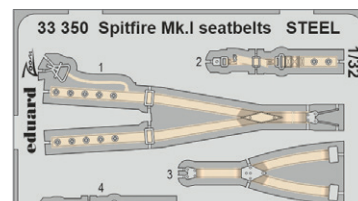

33350 Spitfire Mk.I seatbelts
STEEL 1/32 Kotare
(1 part)

DETAIL

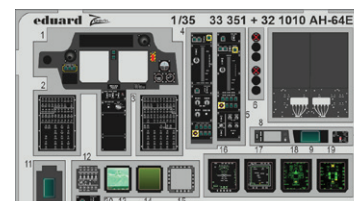

33351 AH-64E
1/35 Takom
(1 part)

DETAIL

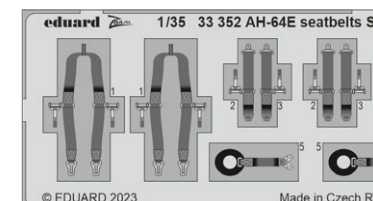

33352 AH-64E seatbelts STEEL
1/35 Takom
(1 part)

DETAIL

PHOTO-ETCHED SETS

ZOOM

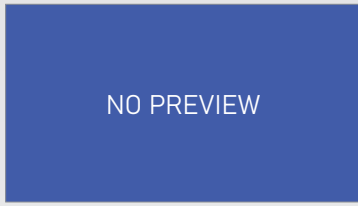

FE1354 Do 335A
1/48 Tamiya
(1 part)

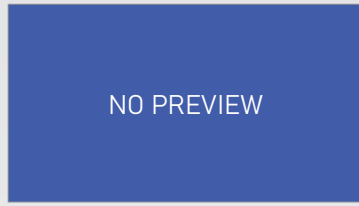

FE1355 Do 335A seatbelts STEEL
1/48 Tamiya
(1 part)

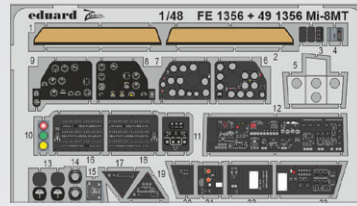

FE1356 Mi-8MT
1/48 Trumpeter
(1 part)

DETAIL

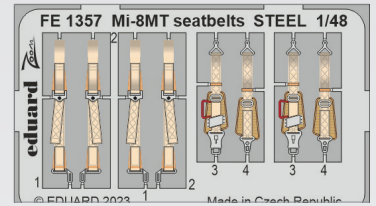

FE1357 Mi-8MT seatbelts STEEL
1/48 Trumpeter
(1 part)

DETAIL



FE1358 F-4E
1/48 Meng
(1 part)

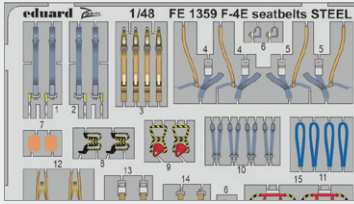

FE1359 F-4E seatbelts STEEL
1/48 Meng
(1 part)

DETAIL

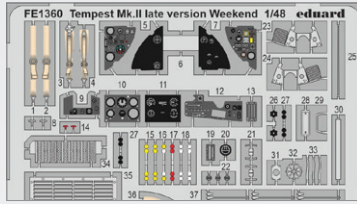

FE1360 Tempest Mk.II Weekend
1/48 Eduard
(1 part)

DETAIL

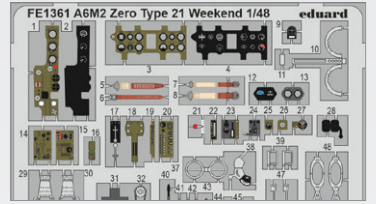

FE1361 A6M2 Zero Type 21 Weekend
1/48 Eduard
(1 part)

DETAIL

BIG ED SETS



BIG33151 Hurricane
Mk.IIb 1/32 Revell

DETAIL



BIG49367 F-16A MLU
1/48 Kinetic

DETAIL



BIG49368 B-25J glazed
nose 1/48 HKM

DETAIL

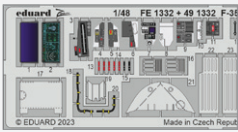

BIG49369 F-35A
1/48 Tamiya

DETAIL



BIG72173 C-130J PART I
1/72 Zvezda

DETAIL

BRASSIN



644215 Mi-8MT LööK
1/48 Zvezda

DETAIL



644216 PV-1 LööK
1/48 Academy/Revell

DETAIL

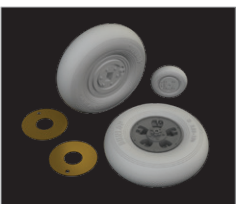

624004 Spitfire Mk.IX
wheels 5spoke 1/24 Airfix

DETAIL



635029 WWII German lamp
headlights PRINT 1/35

DETAIL

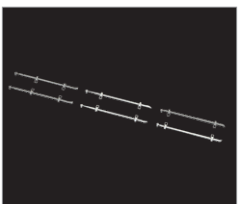

635030 WWII German
crowbars PRINT 1/35

DETAIL

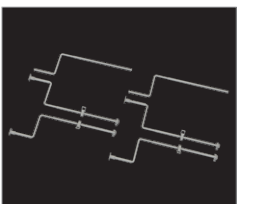

635031 WWII German starter
crank handles PRINT 1/35

DETAIL

BRASSIN



635032 WWII German pickaxes **PRINT** 1/35

DETAIL



648725 Sopwith Camel 2F.1 Lewis gun **PRINT** 1/48 Eduard

DETAIL

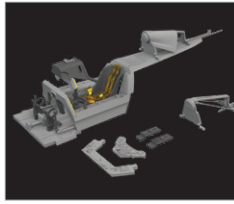

648824 Fw 190F-8 cockpit **PRINT** 1/48 Eduard

DETAIL

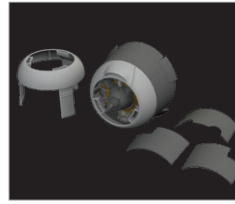

648825 F4F-3 engine mid **PRINT** 1/48 Eduard

DETAIL

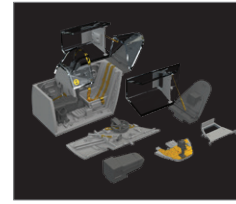

648843 Bf 109G-6 cockpit **PRINT** 1/48 Eduard

DETAIL

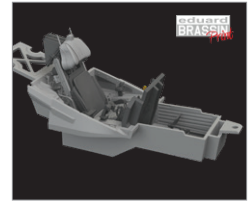

648859 F-35A cockpit **PRINT** 1/48 Tamiya

DETAIL

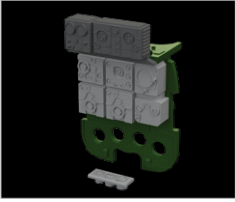

648862 Bf 110G radio equipment 1/48 Eduard

DETAIL



648863 B-25J wheels 1/48 HKM

DETAIL



648864 Mi-8MT wheels 1/48 Zvezda

DETAIL



648865 Mi-17 wheels 1/48 AMK

DETAIL

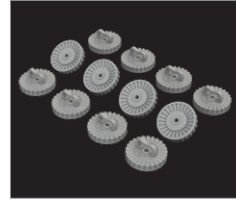

648867 Lewis 47-cartridges ammo magazines **PRINT** 1/48

DETAIL



648869 F-16 ladder **PRINT** 1/48

DETAIL

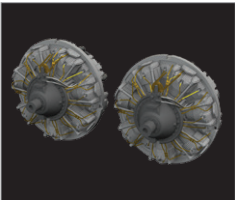

648870 B-25J engines **PRINT** 1/48 HKM

DETAIL

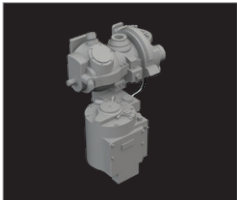

648871 B-25J bombsight **PRINT** 1/48 HKM

DETAIL



672313 Bf 109F propeller early **PRINT** 1/72 Eduard

DETAIL

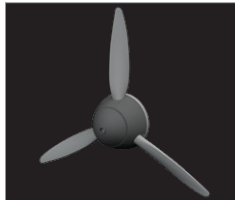

672314 Bf 109F propeller late **PRINT** 1/72 Eduard

DETAIL

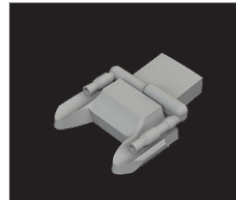

672315 Bf 109F gun barrels **PRINT** 1/72 Eduard

DETAIL



672316 Bf 109F wheels **PRINT** 1/72 Eduard

DETAIL

LööKplus

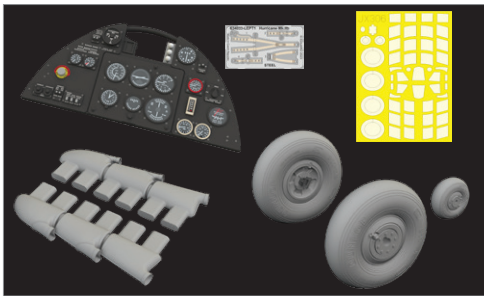

634035 Hurricane Mk.IIb w/ rounded exhausts **LööKplus** 1/32 Revell

DETAIL

LööKplus

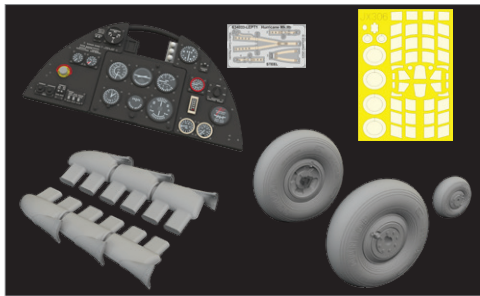

634037 Hurricane Mk.IIb w/ fishtail exhausts **LööKplus** 1/32 Revell

DETAIL

LööKplus

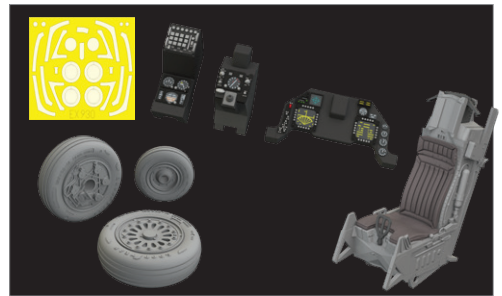

644214 F-16A MLU **LööKplus** 1/48 Kinetic

DETAIL

BIGSIN

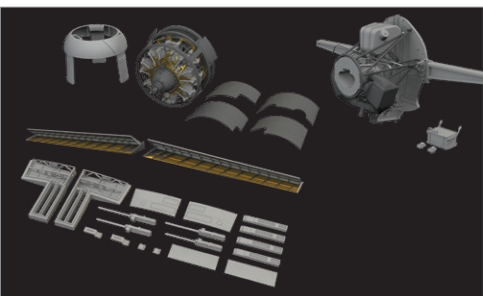

SIN648105 F4F-3 w/ early engine **ADVANCED** 1/48 Eduard

DETAIL

BIGSIN

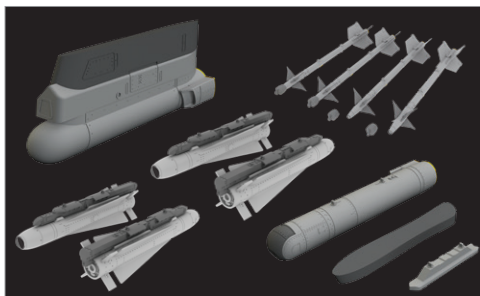

SIN648106 F-16 armament w/ Maverick missiles 1/48 Kinetic

DETAIL

The ProfiPACK edition kit of British WWI fighter Sopwith 2F.1 Camel in 1/48 scale. This version of the legendary fighter was designed as the aircraft to be launched from the platforms mounted on the turrets of the major warships or from the early aircraft carriers. The split and folding fuselage helped to stow "Ship's Camels" on the decks.

BASIC INFO:

NAME: **Sopwith 2F.1 Camel**

CAT. NO.: 82173

SCALE: 1/48

EDITION: ProfiPACK

CONTENTS:

SPRUES: Eduard

PE-SETS: Yes, pre-painted

PAINTING MASK: Yes

MARKING OPTIONS: 6

BRASSIN: No

RELATED PRODUCTS:

FE1215 Sopwith Camel seatbelts STEEL (PE-Set)

644116 Sopwith Camel LööK (Brassin)

648657 Sopwith Camel wheels Type 1 (Brassin)

648658 Sopwith Camel wheels Type 2 (Brassin)

648659 Sopwith Camel seat PRINT (Brassin)

648660 Sopwith Camel Vickers Mk.I gun (Brassin)

648661 Sopwith Camel US Colt Vickers gun (Brassin)

648725 Sopwith Camel 2F.1 Lewis gun PRINT (Brassin)

648674 Sopwith Camel Rotherham air pumps PRINT (Brassin)

648677 Sopwith Camel Bentley engine PRINT (Brassin)

3DL48038 Sopwith Camel SPACE (3D Decal Set)

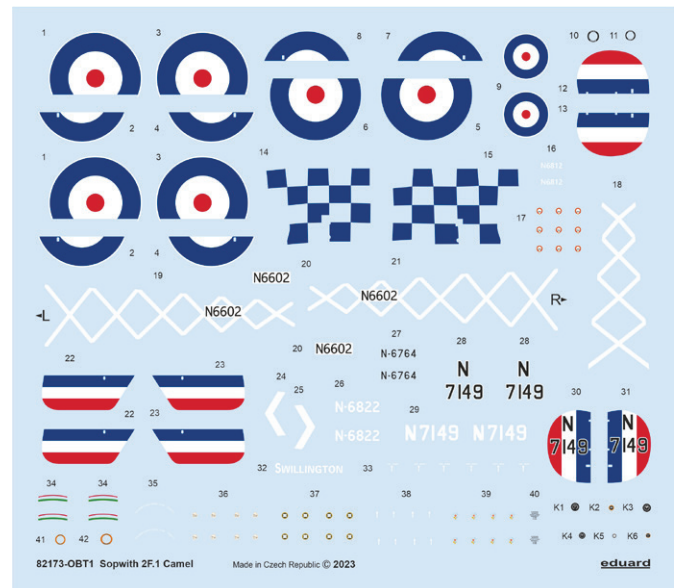

KIT PARTS

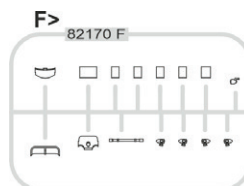
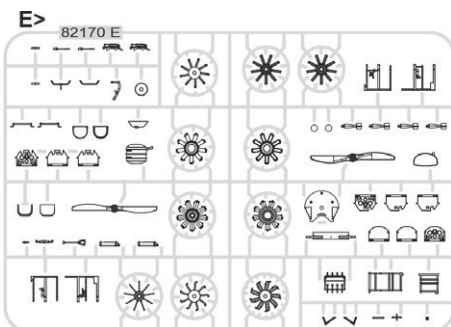
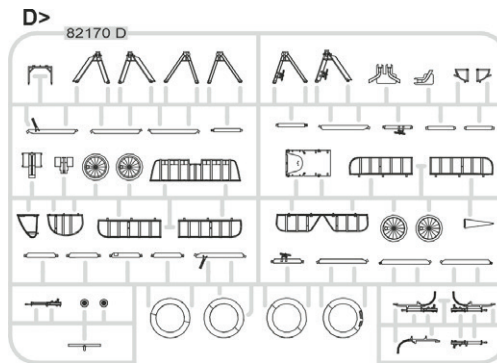
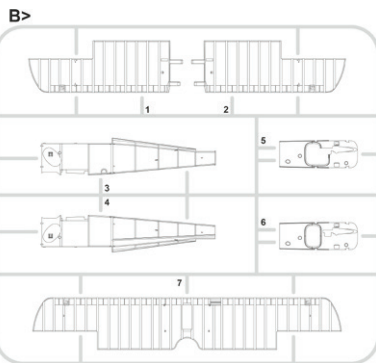

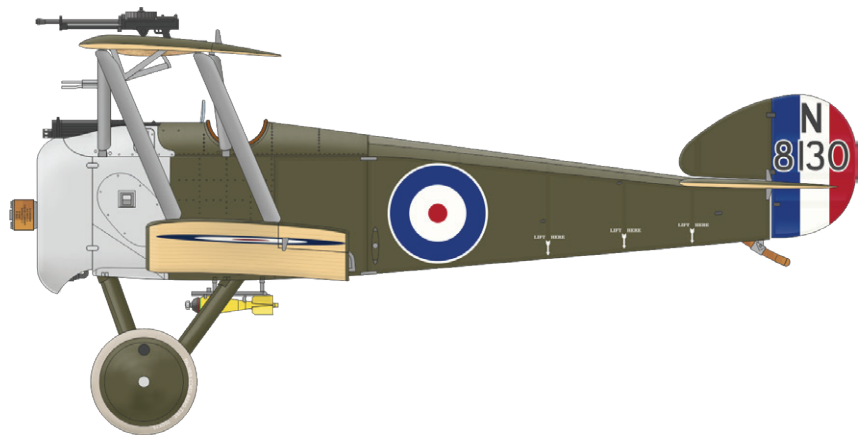
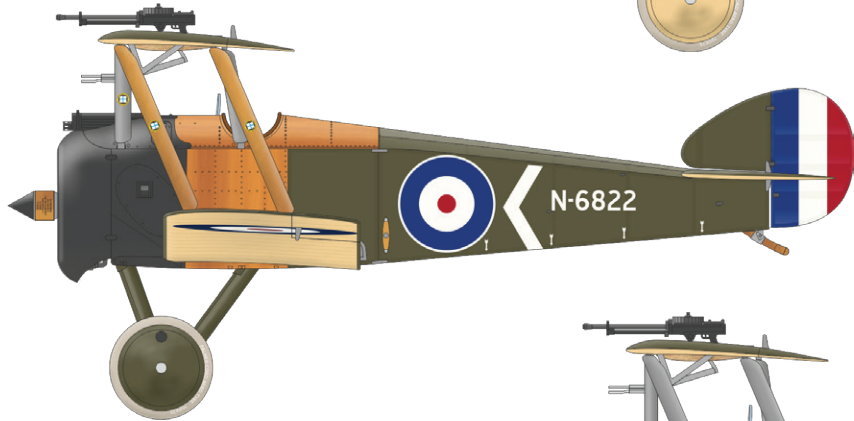
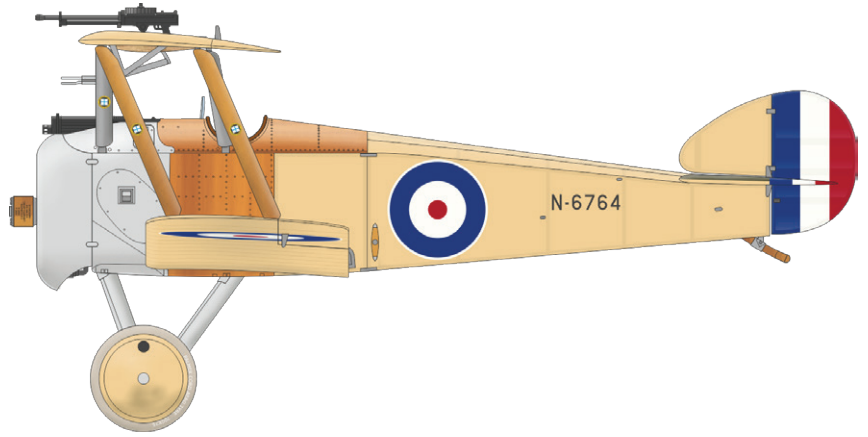
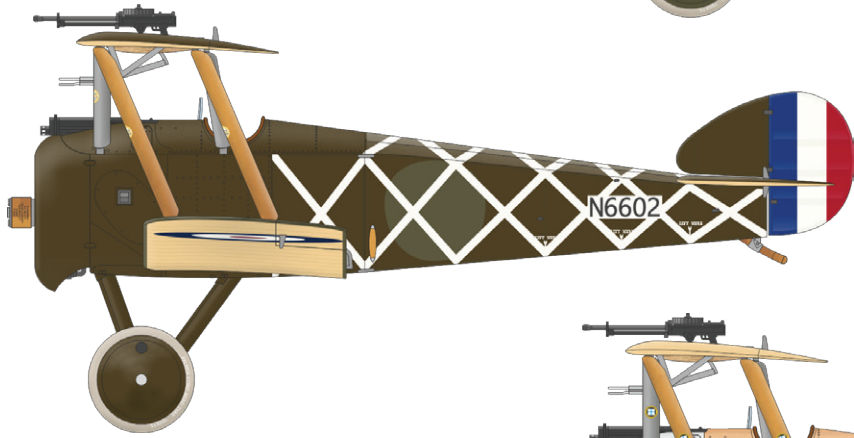
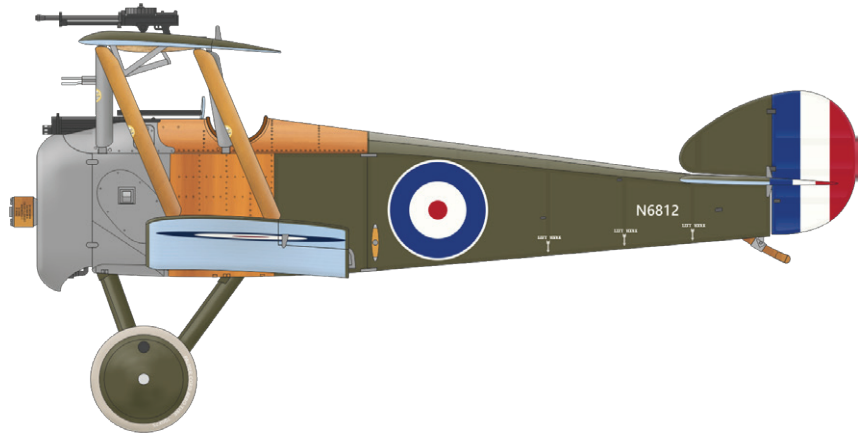
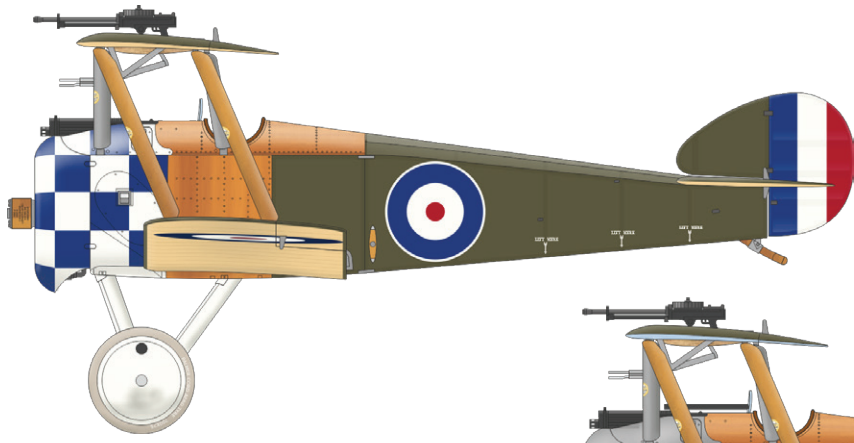

The Limited edition of the kit of the famous German WWII fighter aircraft Bf 109F in 1/72 scale. The kit offers aircraft of F-2 and F-4 versions. Marking selection covers all fronts of WWII where these "Friedrichs" were fighting.

DUAL COMBO

1/72

BASIC INFO:

NAME: **WUNDERSCHÖNE NEUE MASCHINEN pt. 1 DUAL COMBO**

CAT. NO.: 2142

SCALE: 1/72

EDITION: LIMITED

CONTENTS:

SPRUES: Eduard

PE-SETS: Yes, pre-painted

PAINTING MASK: Yes

MARKING OPTIONS: 14

BRASSIN: No

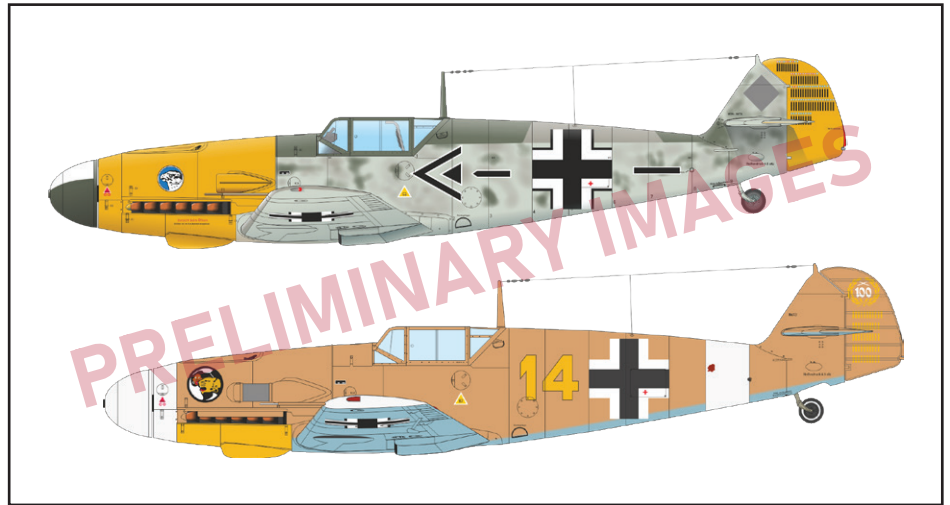

RELATED PRODUCTS:

672313 Bf 109F propeller early PRINT (Brassin)

672314 Bf 109F propeller late PRINT (Brassin)

672315 Bf 109F gun barrels PRINT (Brassin)

672316 Bf 109F wheels PRINT (Brassin)

3DL72018 Bf 109F SPACE (3D Decal Set)

KIT PARTS

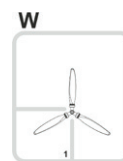
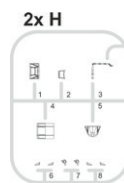
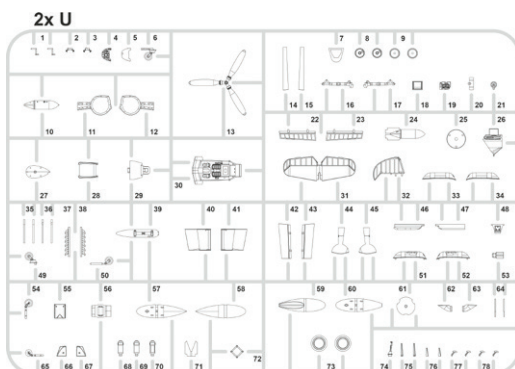
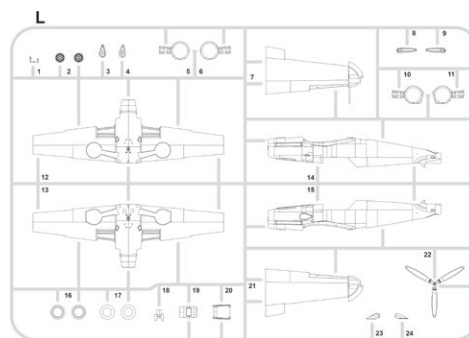
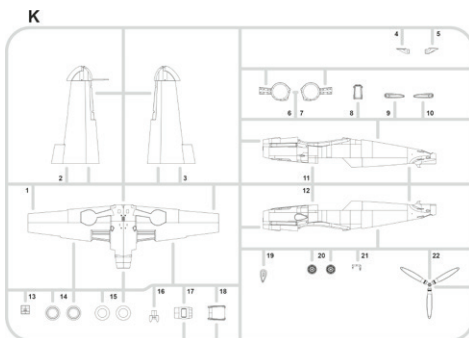



+ three more marking options

Weekend edition kit of Japanese WWII naval fighter plane A6M2 Zero Type 21 in 1/48 scale.

BASIC INFO:

NAME: **A6M2 Zero Type 21**

CAT. NO.: 84189

SCALE: 1/48

EDITION: Weekend edition

CONTENTS:

SPRUES: Eduard

PE-SETS: No

PAINTING MASK: No

MARKING OPTIONS: 4

BRASSIN: No

RELATED PRODUCTS:

481076 A6M2 landing flaps (PE-Set)

481077 A6M2 Zero (PE-Set)

FE1238 A6M2 seatbelts STEEL (PE-Set)

644128 A6M2 LööK (Brassin)

644134 A6M2 LööKplus (Brassin)

648692 A6M2 Zero Model 21 cockpit PRINT (Brassin)

648693 A6M2 wheels (Brassin)

648694 A6M2 engine PRINT (Brassin)

648695 A6M2 undercarriage legs BRONZE (Brassin)

648698 A6M2 seat PRINT (Brassin)

648722 A6M2 exhausts PRINT (Brassin)

648723 A6M2 cannon barrels & cockpit guns PRINT (Brassin)

648724 A6M2 landing flaps PRINT (Brassin)

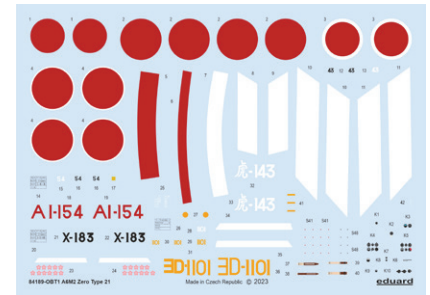
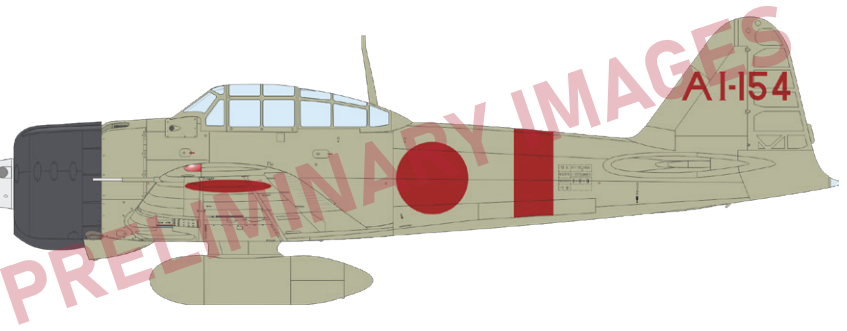

648731 A6M2 Zero Model 21 folding wingtips PRINT (Brassin)

648763 A6M2 engine complete PRINT (Brassin)

648771 A6M2 gun bays PRINT (Brassin)

648772 A6M2 tailwheel PRINT (Brassin)

648808 A6M2 wheels w/smooth tire (Brassin)

3DL48050 A6M2 SPACE (3D Decal Set)

D48098 A6M2 stencils (Decal Set)

D48100 A6M2 national insignia (Decal Set)

EX821 A6M2 TFace (Mask)

KIT PARTS

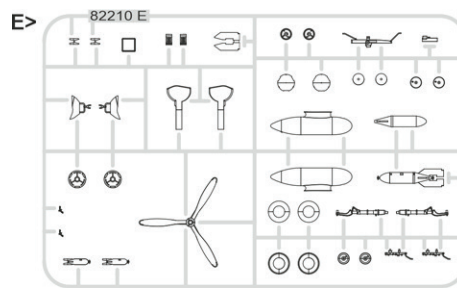
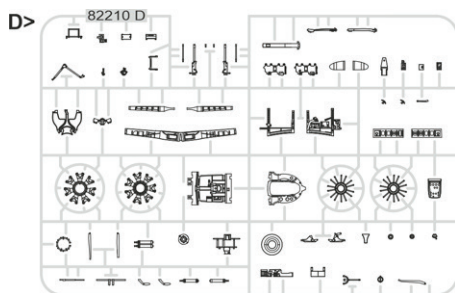
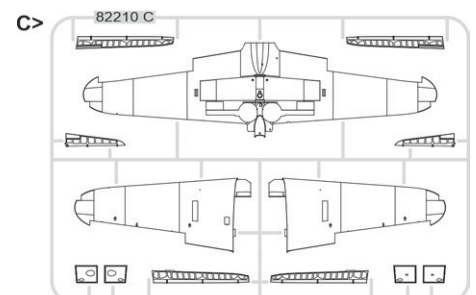
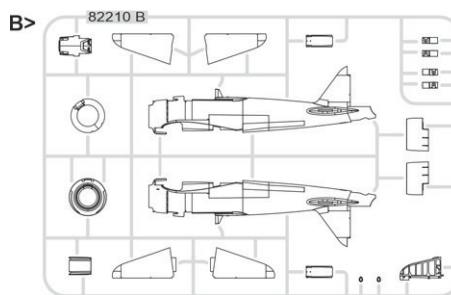
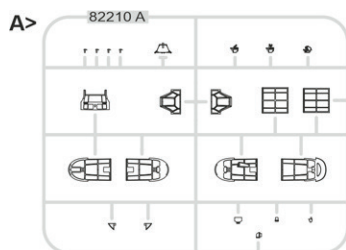

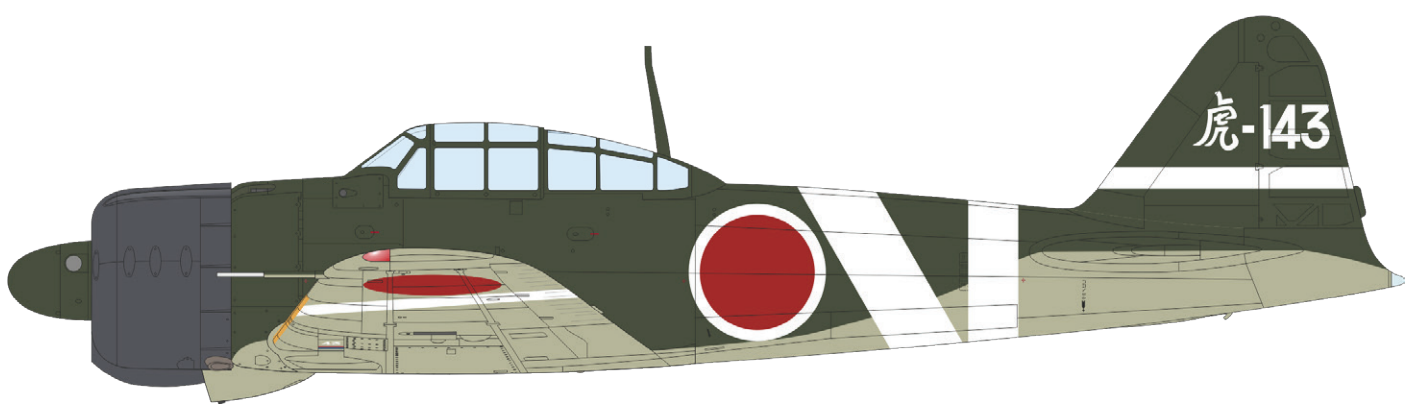
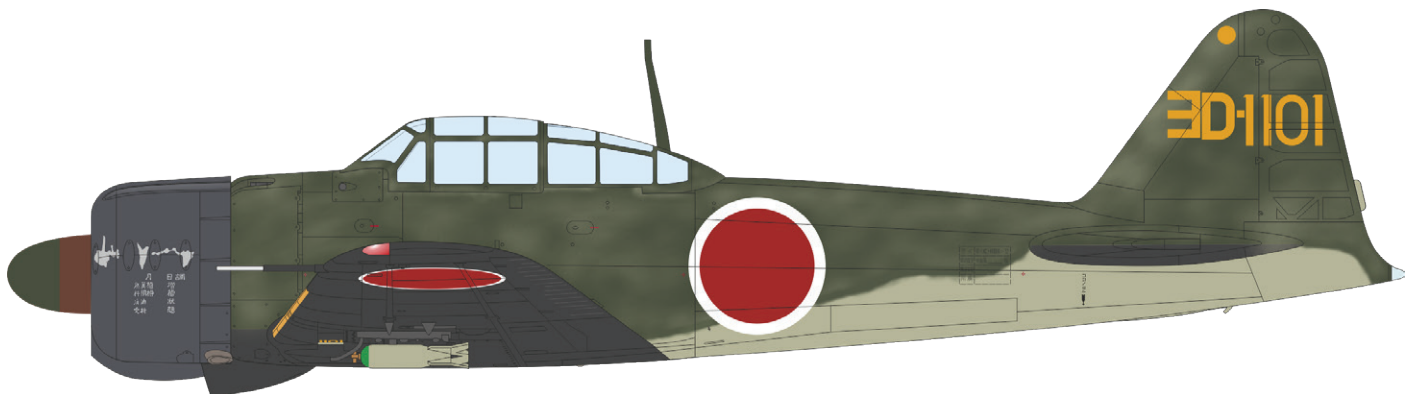
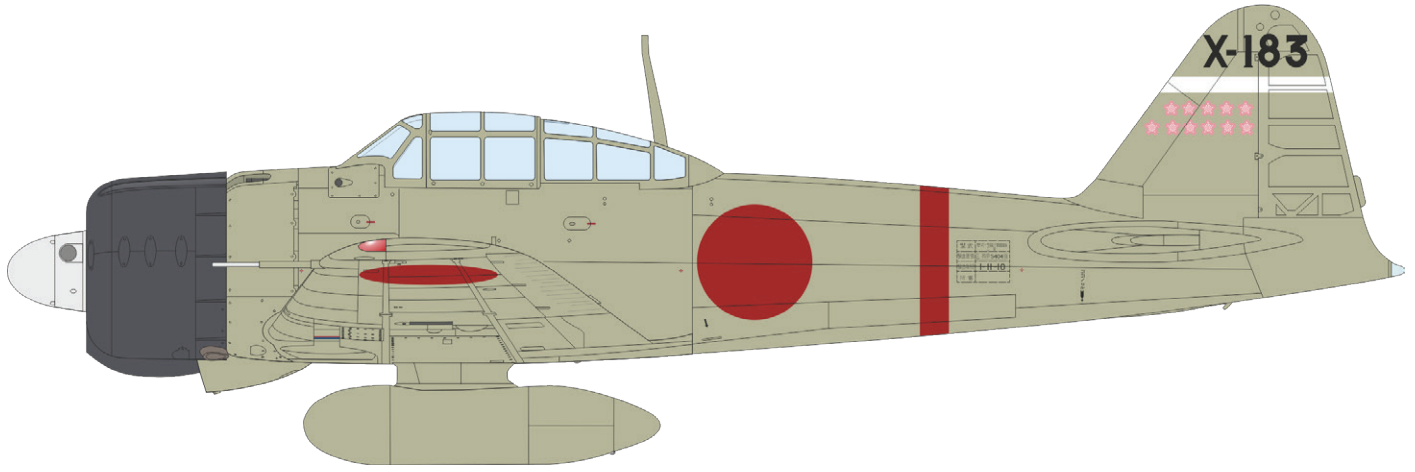
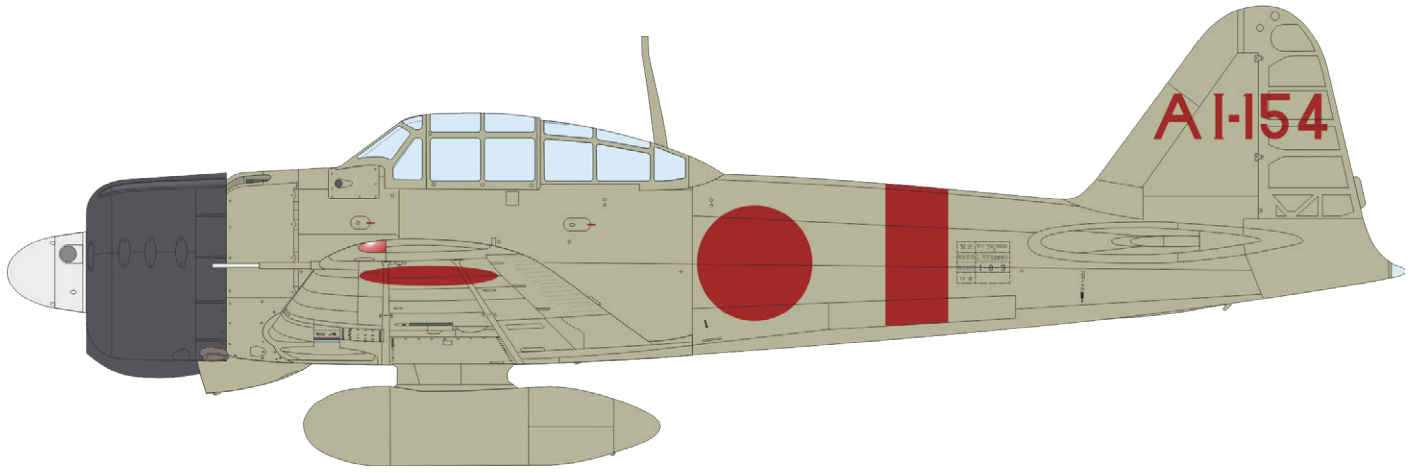

The Weekend edition kit of British fighter aircraft Tempest Mk.II in 1/48 scale. The marking selection offers RAF, Royal Pakistan Air Force and Indian Air Force markings.

BASIC INFO:

NAME: **Tempest Mk.II**

CAT. NO.: 84190

SCALE: 1/48

EDITION: Weekend edition

CONTENTS:

SPRUES: Eduard

PE-SETS: No

PAINTING MASK: No

MARKING OPTIONS: 4

BRASSIN: No

RELATED PRODUCTS:

481064 Tempest Mk.II landing flaps (PE-Set)

FE1208 Tempest Mk.II seatbelts STEEL (PE-Set)

644104 Tempest Mk.II LööK (Brassin)

644115 Tempest Mk.II LööKplus (Brassin)

648636 Tempest Mk.II wheels (Brassin)

648637 Tempest Mk.II undercarriage legs BRONZE (Brassin)

648638 Tempest Mk.II gun bays (Brassin)

648639 Tempest Mk.II cockpit (Brassin)

648641 RP-3 60lb rockets for Tempest Mk.II (Brassin)

648654 Tempest Mk.II exhaust stacks (Brassin)

648686 Tempest Mk.II landing flaps PRINT (Brassin)

SIN64875 Tempest Mk.II ESSENTIAL (Brassin)

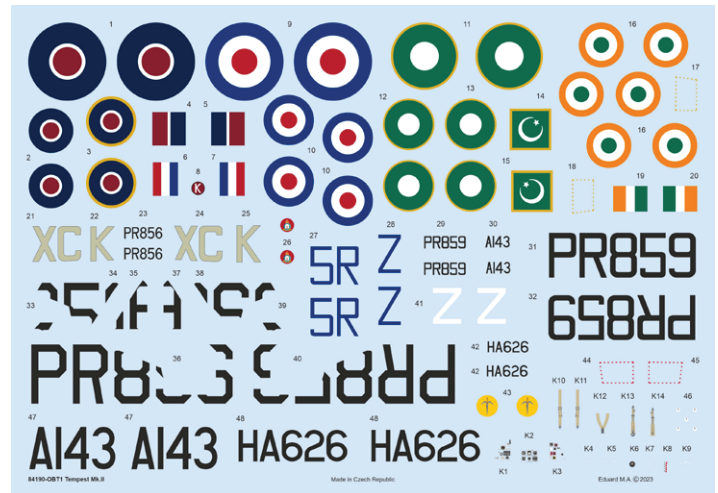
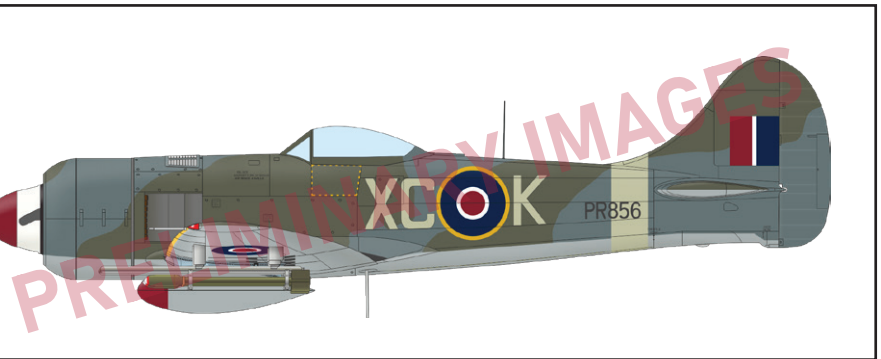

3DL48030 Tempest Mk.II SPACE (3D Decal Set)

D48086 Tempest Mk.II stencils (Decal Set)

D48087 Tempest Mk.II roundels (Decal Set)

EX796 Tempest Mk.II TFace (Mask)

KIT PARTS

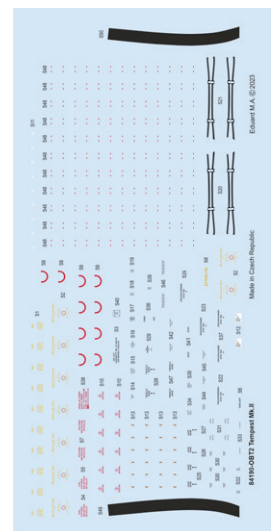
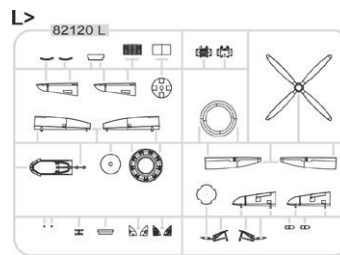
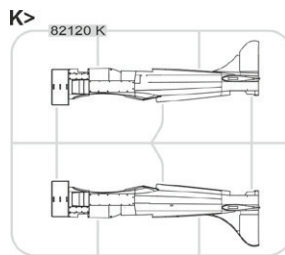
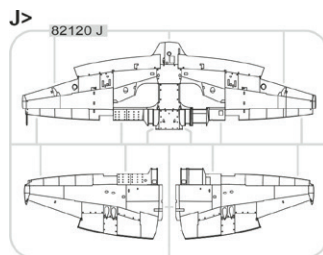
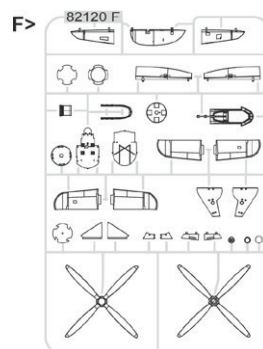
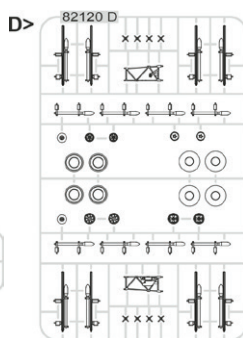
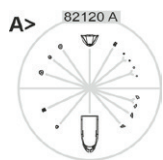

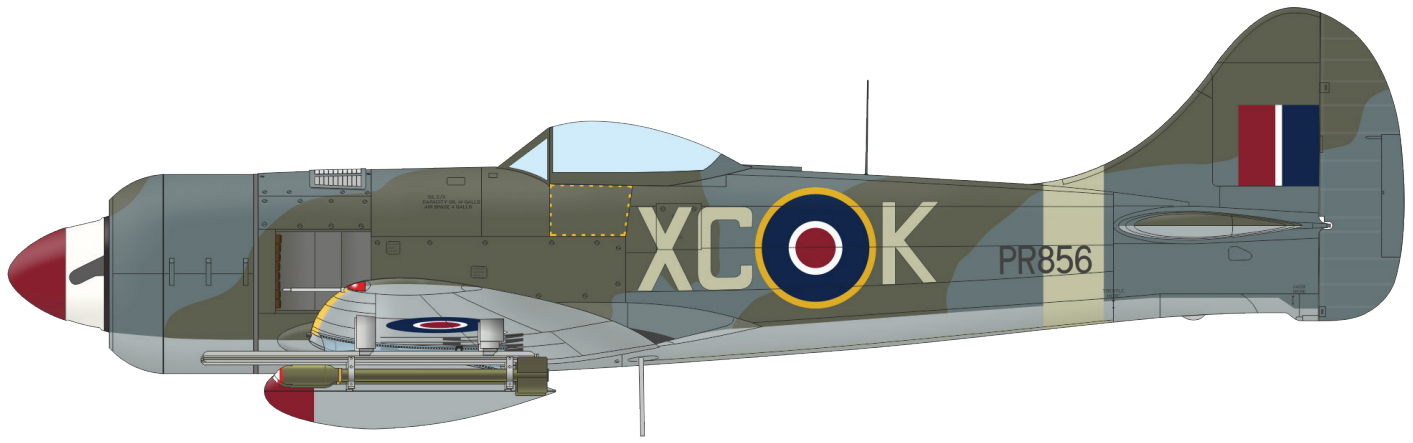

PR856, F/Lt Jack Frost, No. 26 Sqn, No. 135 Wing BAFQ, Zeltweg, Austria, July 1947

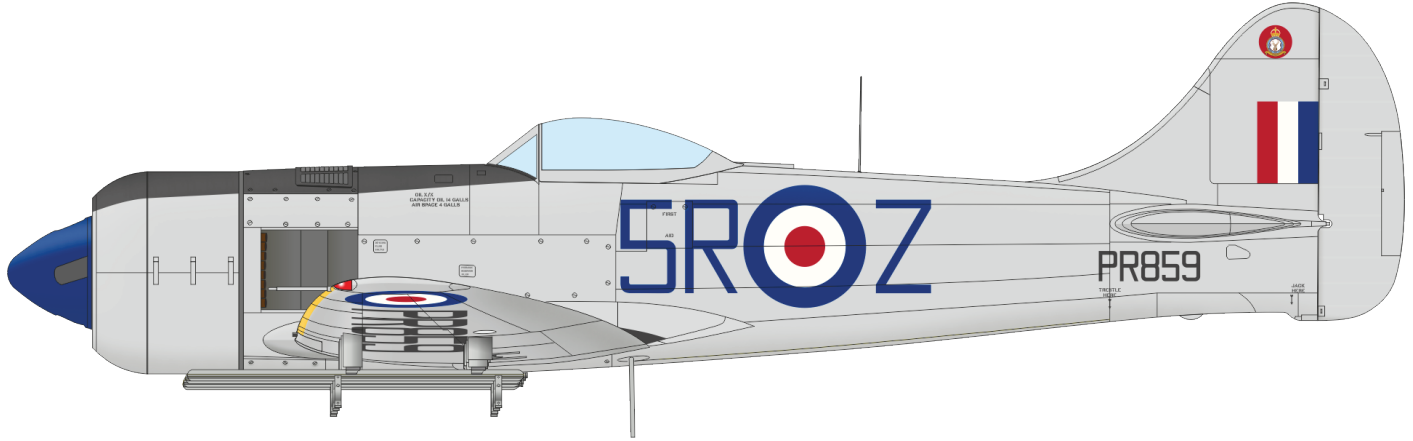

PR859, No. 33 Squadron, Butterworth, Malaysia, October 1949

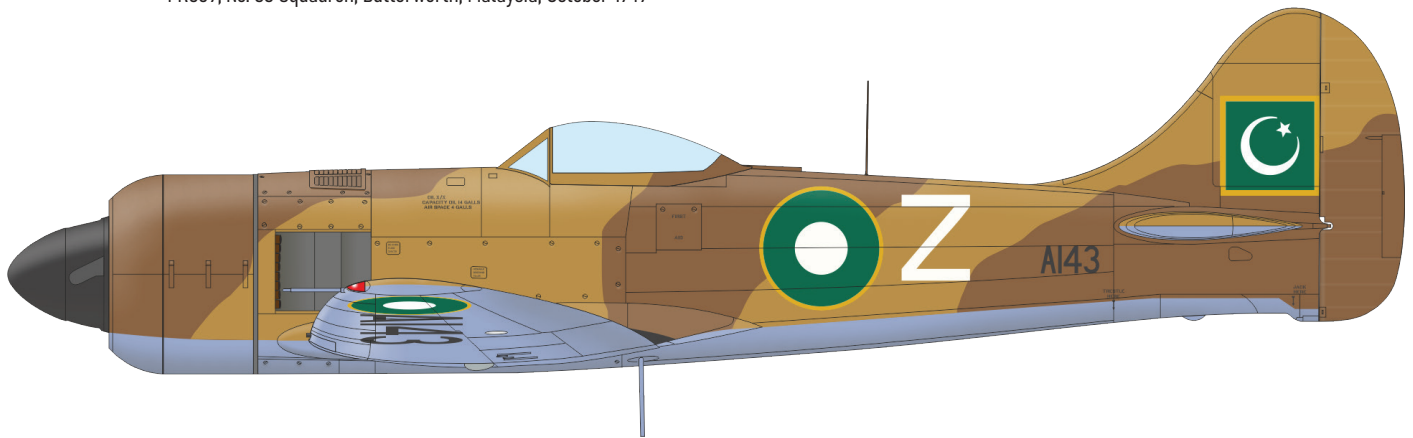

AI43, No. 14 Squadron, Royal Pakistan Air Force, Pakistan, 1949-1950

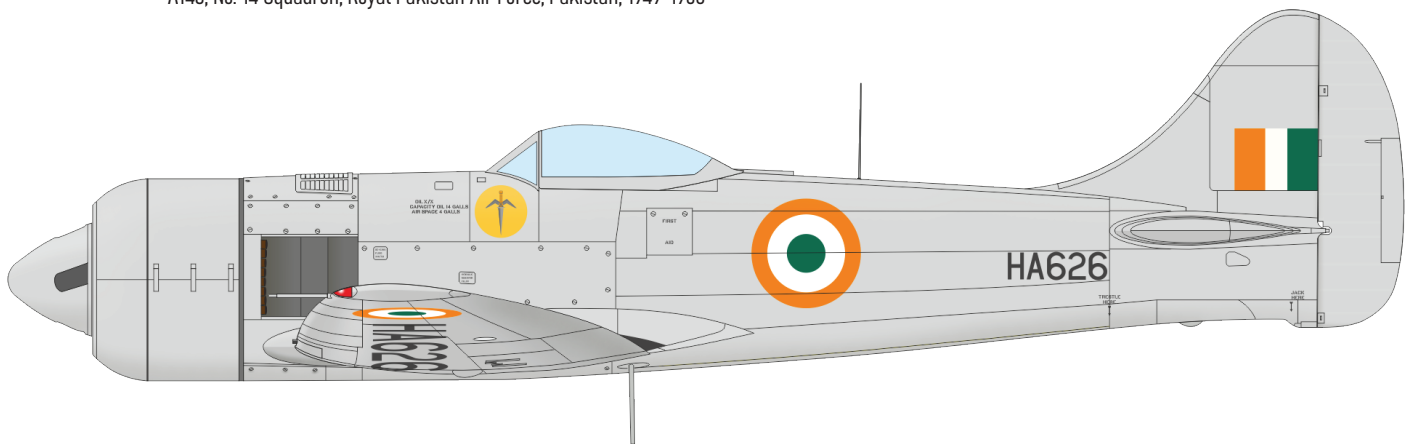

HA626 (ex MW391), F/O, Ian S. Loughran, No. 10 Squadron, Royal Indian Air Force, Jamnagar, India, January 1952

The ProfiPACK edition of German fighter aircraft Bf 109G-6 in 1/48 scale. The kit features Bf 109G-6 with so-called Erla canopy and standard or redesigned bigger tailplane.

Re-release

BASIC INFO:

NAME: **Bf 109G-6 late series Re-release**

CAT. NO.: 82111

SCALE: 1/48

EDITION: ProfiPACK

CONTENTS:

SPRUES: Eduard

PE-SETS: Yes, pre-painted

PAINTING MASK: Yes

MARKING OPTIONS: 5

BRASSIN: No



RELATED PRODUCTS:

48885 Bf 109G-6 (PE-Set)

FE910 Bf 109G seatbelts STEEL (PE-Set)

644003 Bf 109G-6 LööK (Brassin)

644060 Bf 109G-6 LööKplus (Brassin)

648240 Bf 109G-6 cockpit (Brassin)

648247 Bf 109G exhaust stacks (Brassin)

648250 Bf 109G-6 engine & fuselage guns (Brassin)

648255 Bf 109G-6 propeller (Brassin)

648261 Bf 109G-6 wheels (Brassin)

648265 Bf 109G external fuel tanks (Brassin)

648309 Bf 109G undercarriage legs BRONZE (Brassin)

648310 Bf 109G control surfaces (Brassin)

648843 Bf 109G-6 cockpit PRINT (Brassin)

3DL48014 Bf 109G-6 SPACE (3D Decal Set)

D48025 Bf 109G stencils (Decal Set)

D48027 Bf 109G Balkenkreuze (Decal Set)

D48045 Bf 109G-6 national insignia (Decal Set)

D48050 WILDE SAU Bf 109G-6 JG 300 (Decal Set)

D48051 WILDE SAU Bf 109G-6 JG 301/302 (Decal Set)

EX509 Bf 109G camo scheme - Mtt (Mask)

EX510 Bf 109G camo scheme - Erla (Mask)

EX511 Bf 109G camo scheme - WNF (Mask)

EX512 Bf 109G spinner spirals (Mask)

EX581 Bf 109G Erla canopy TFace (Mask)

KIT PARTS

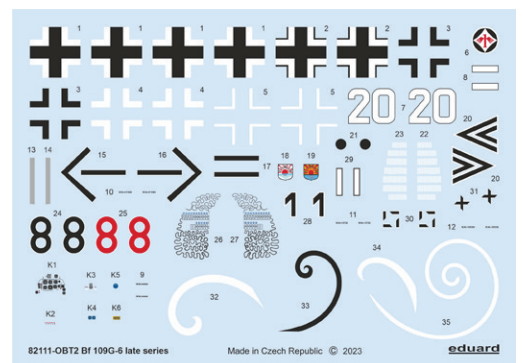
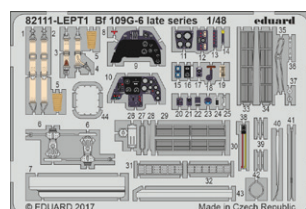
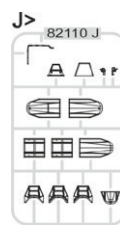
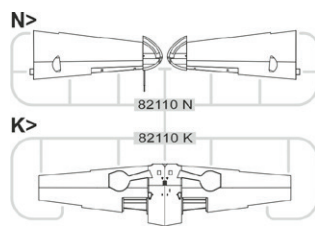
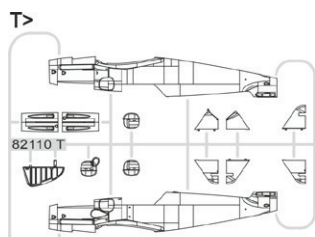
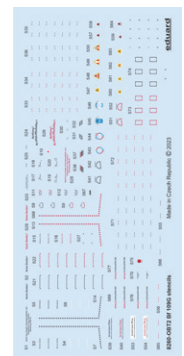
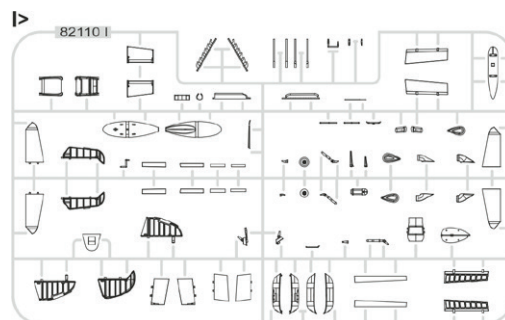
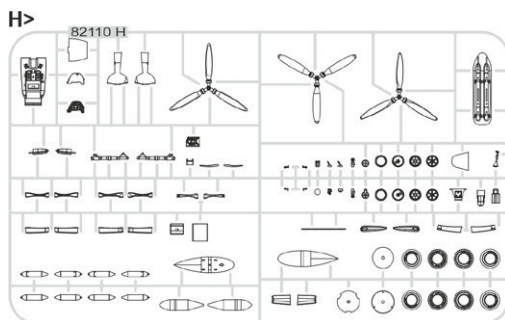

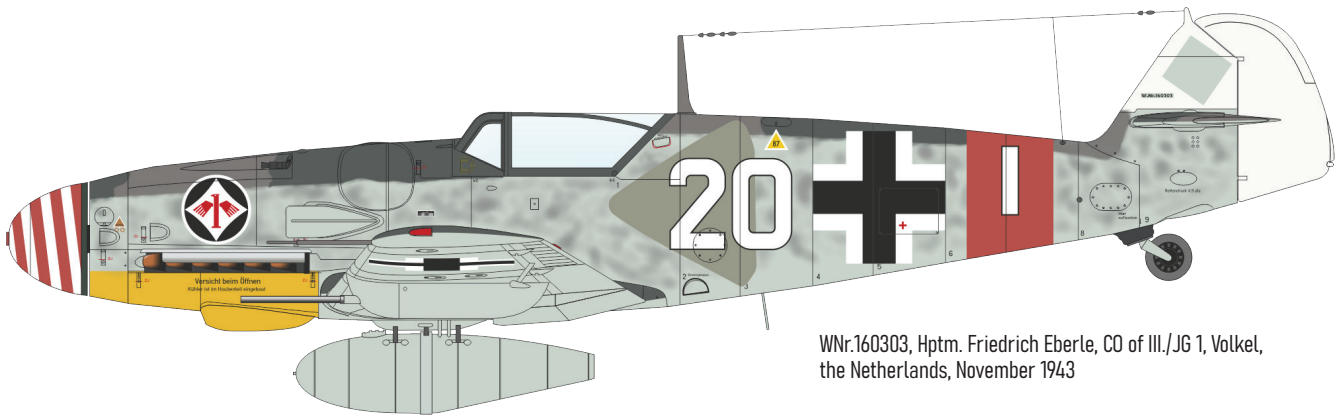

WNR.160303, Hptm. Friedrich Eberle, CO of III./JG 1, Volkel, the Netherlands, November 1943

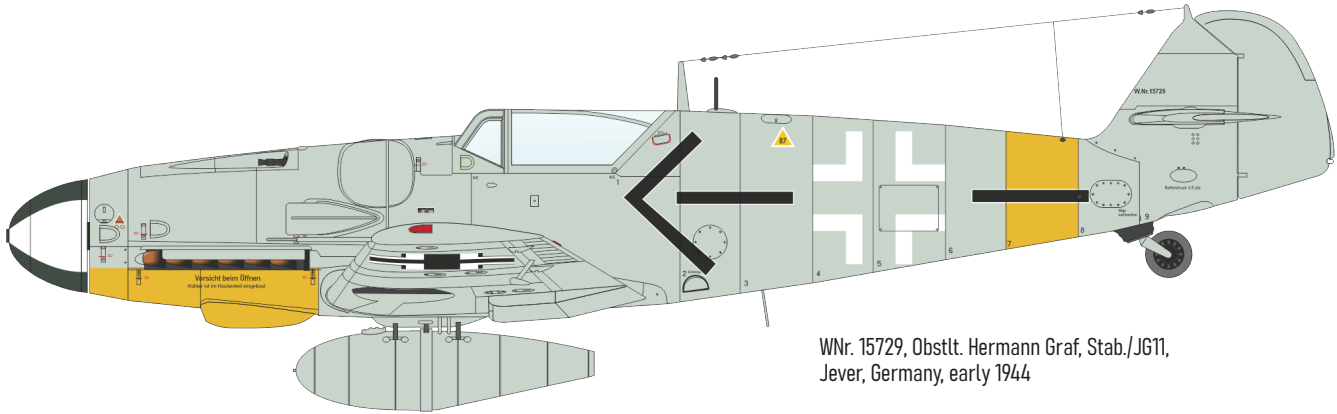

WNR. 15729, Obstlt. Hermann Graf, Stab./JG11, Jever, Germany, early 1944

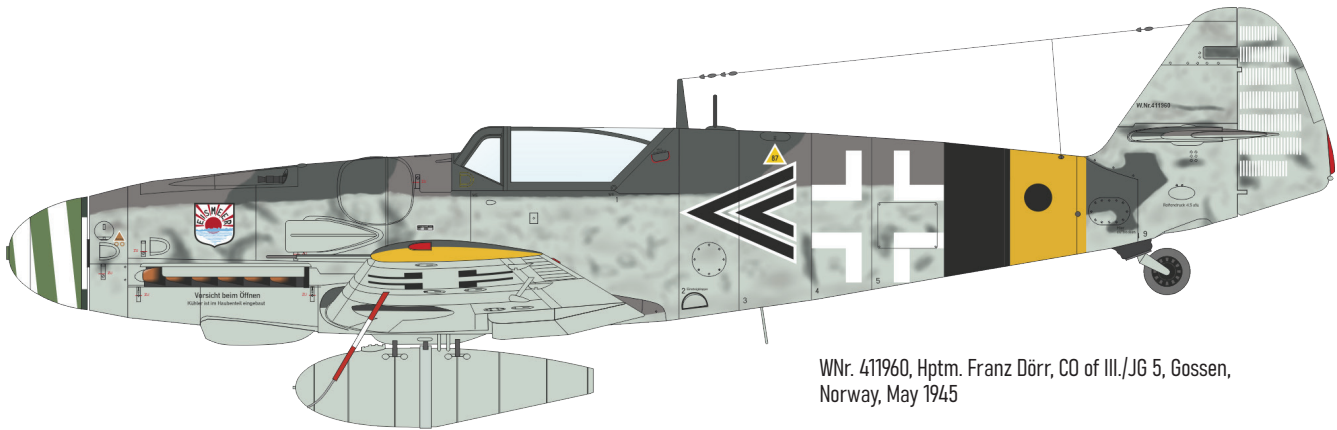

WNR. 411960, Hptm. Franz Dörr, CO of III./JG 5, Gossen, Norway, May 1945

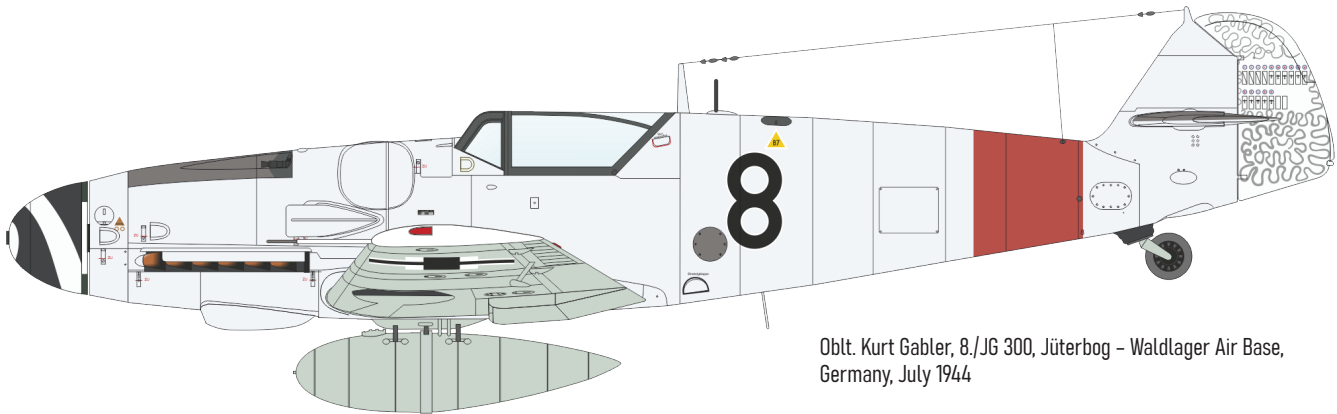

Obt. Kurt Gabler, 8./JG 300, Jüterbog - Waldlager Air Base, Germany, July 1944

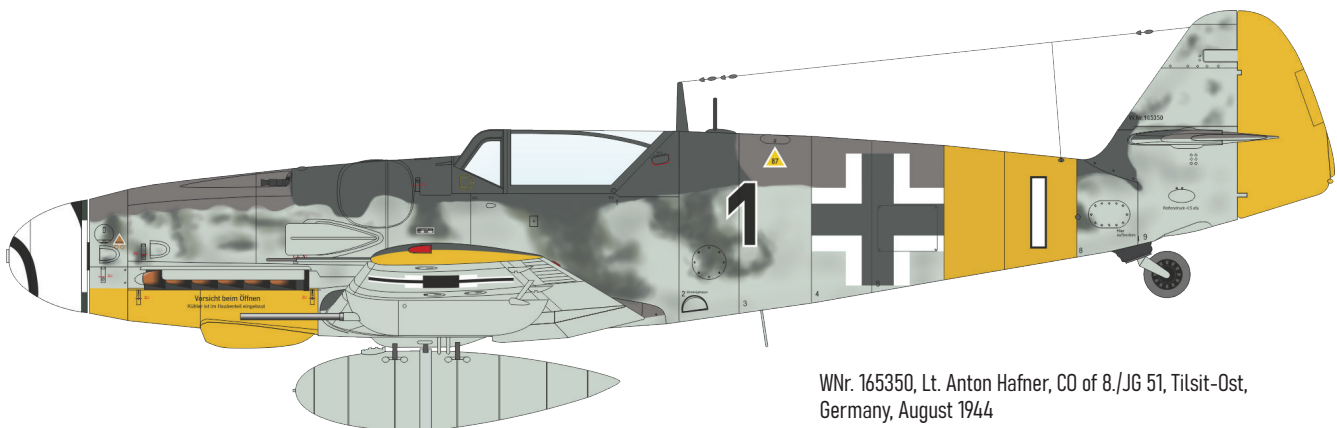

WNR. 165350, Lt. Anton Hafner, CO of 8./JG 51, Tilsit-Ost, Germany, August 1944

321009 Spitfire Mk.I
1/32 Kotare

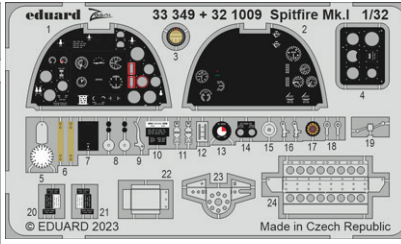
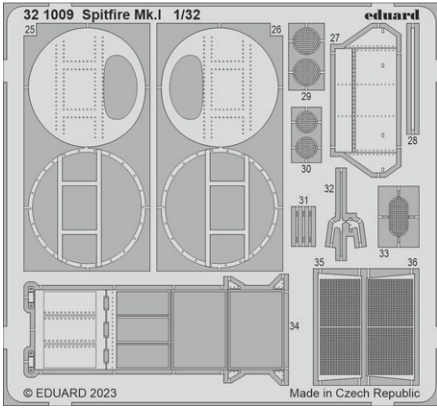

321010 AH-64E
1/35 Takom

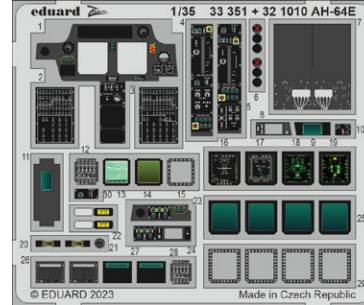
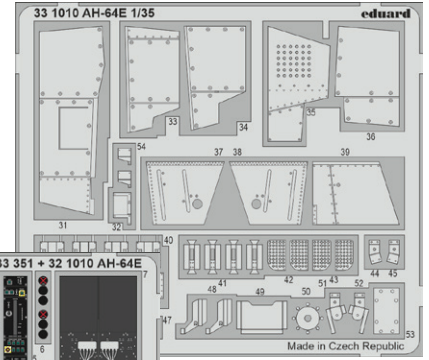

36501 M3A4
1/35 I Love Kits

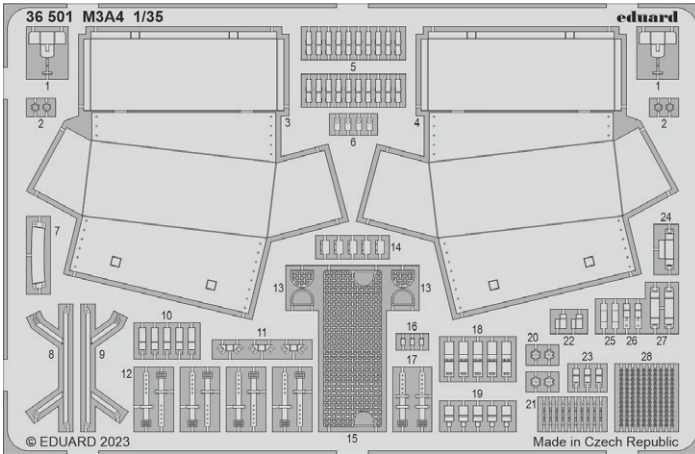

36502 Panzer IV/70 (A)
1/35 Tamiya

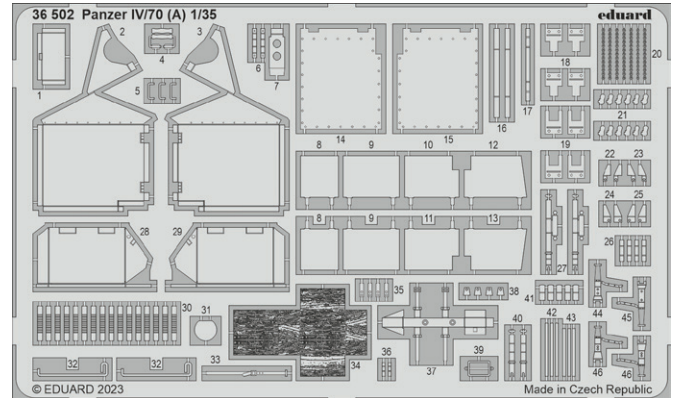

36503 Scammell Commander w/ 62t semitrailer
1/35 Hobby Boss

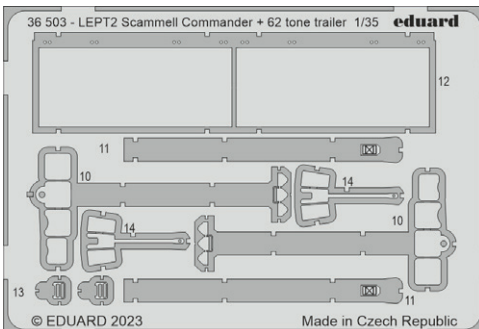

481111 Mi-8MT cargo floor
1/48 Trumpeter

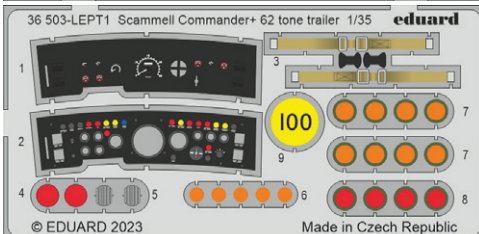
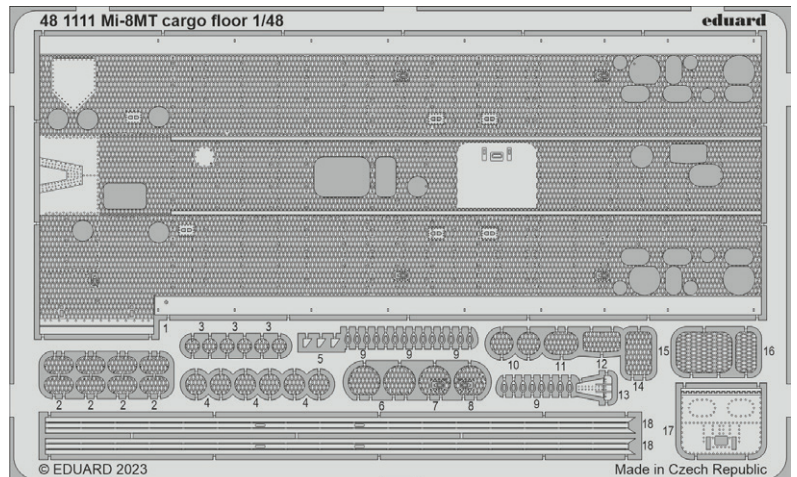

481112 Mi-8MT cargo seats
1/48 Trumpeter

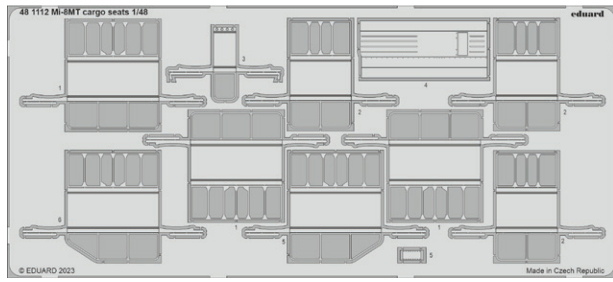

491356 Mi-8MT
1/48 Trumpeter

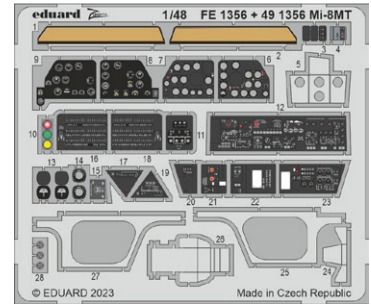
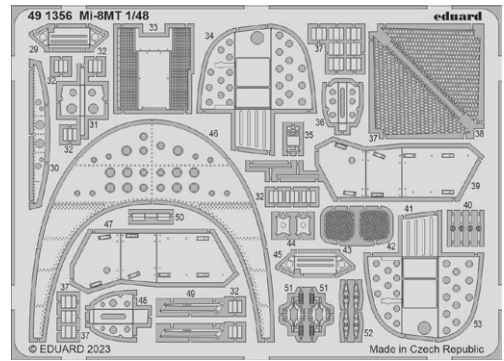

491357 Mi-8MT cargo seatbelts STEEL
1/48 Trumpeter

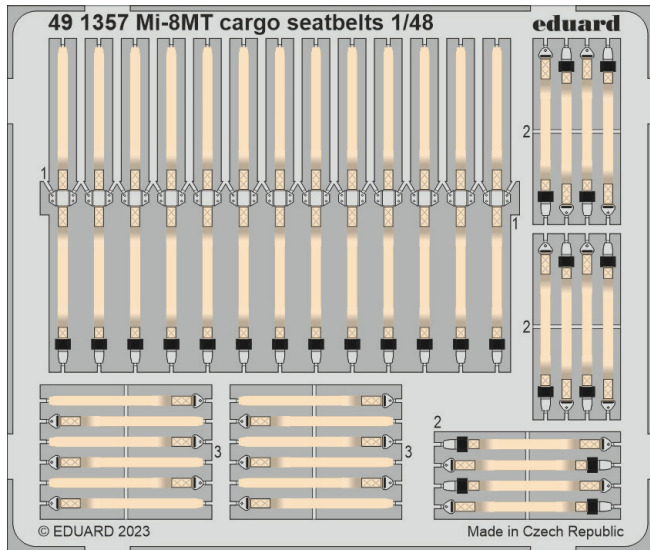

33349 Spitfire Mk.I
1/32 Kotare

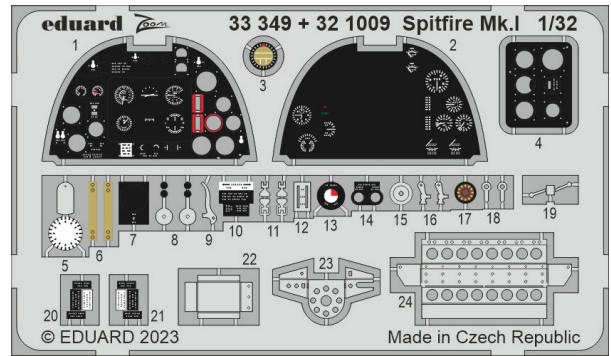

33350 Spitfire Mk.I seatbelts STEEL
1/32 Kotare

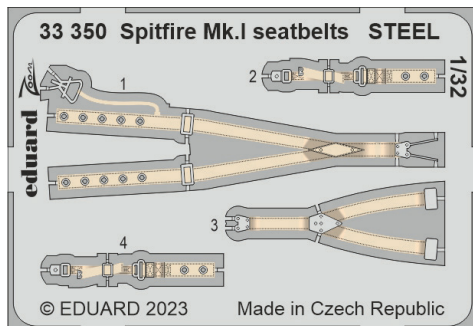

33351 AH-64E
1/35 Takom

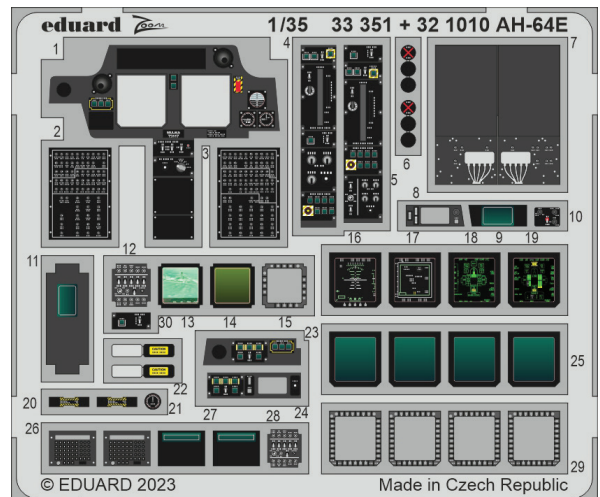

33352 AH-64E seatbelts STEEL
1/35 Takom

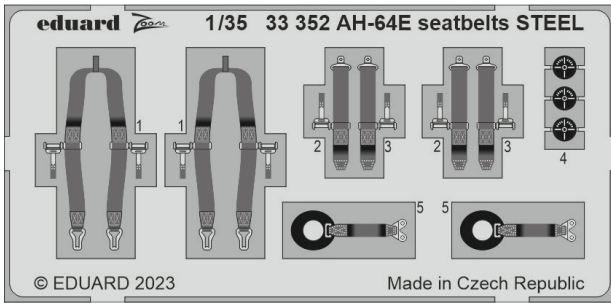

FE1356 Mi-8MT
1/48 Trumpeter

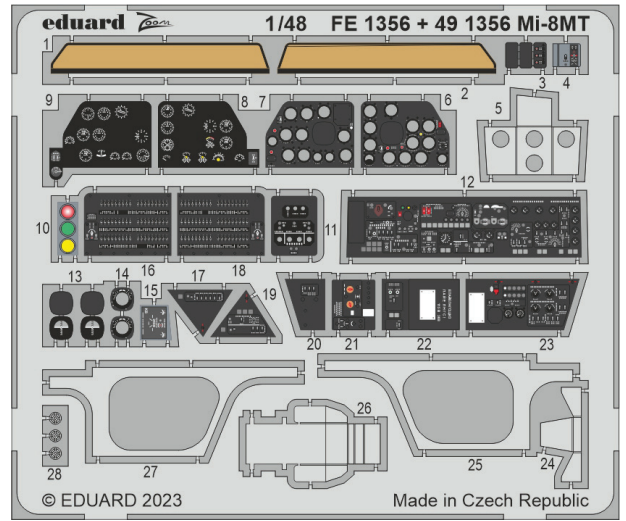

FE1357 Mi-8MT seatbelts STEEL
1/48 Trumpeter

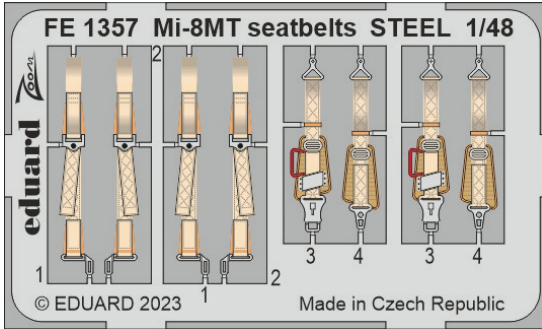

FE1359 F-4E seatbelts STEEL
1/48 Meng

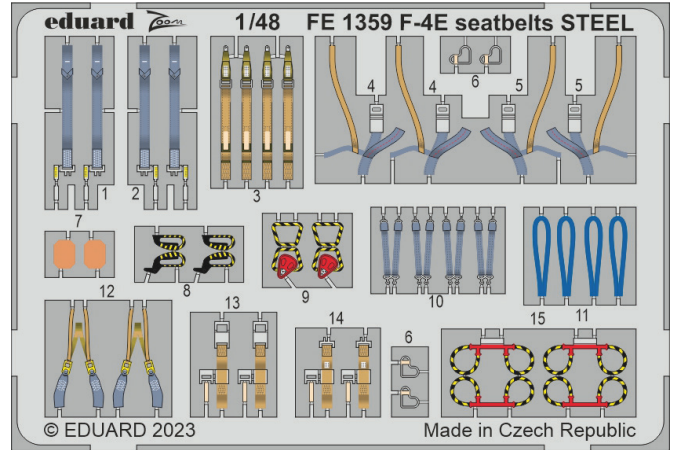

FE1360 Tempest Mk.II Weekend
1/48 Eduard

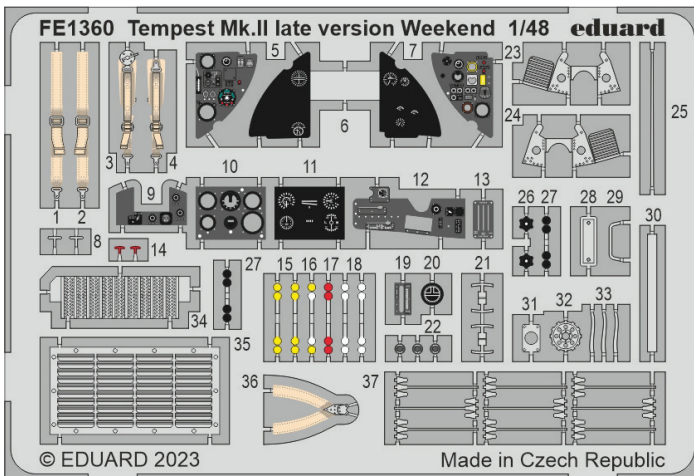

FE1361 A6M2 Zero Type 21 Weekend
1/48 Eduard

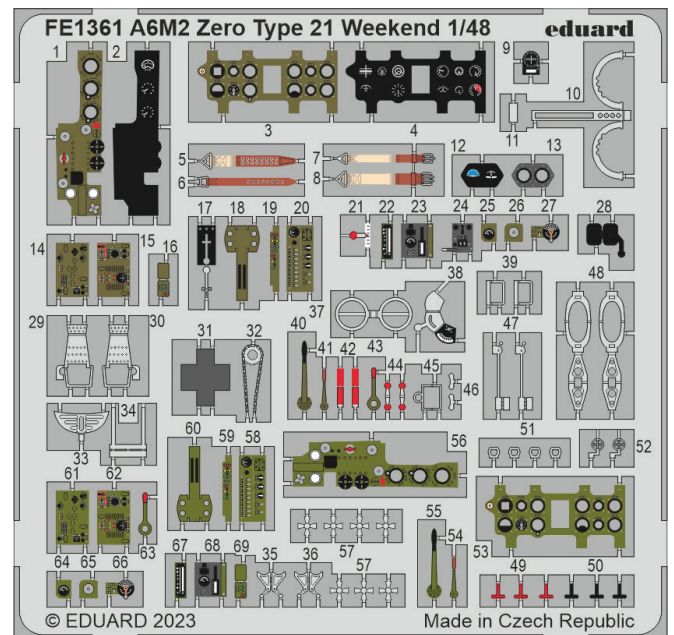

644215 Mi-8MT LööK 1/48 Zvezda

LööK set - Brassin pre-painted dashboard and STEEL seatbelts for Mi-8MT in 1/48 scale. Easy to assemble, replaces plastic parts. Recommended kit: Zvezda

Set contains:

- resin: 3 parts
- decals: no
- photo-etched details: yes, pre-painted
- painting mask: no

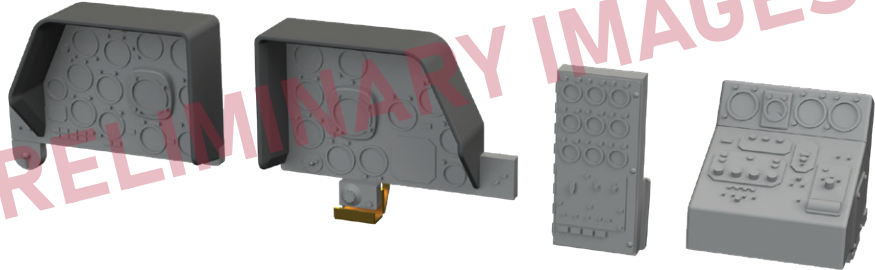

644216 PV-1 LööK 1/48 Academy/Revell

LööK set - Brassin pre-painted dashboard and STEEL seatbelts for PV-1 in 1/48 scale. Easy to assemble, replaces plastic parts. Recommended kit: Academy / Revell

Set contains:

- resin: 3 parts
- decals: no
- photo-etched details: yes, pre-painted
- painting mask: no

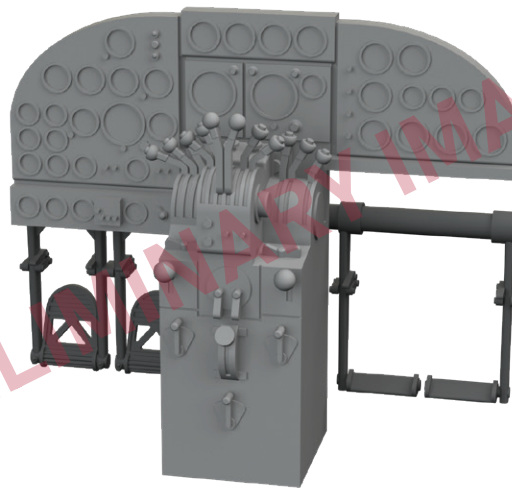

624004 Spitfire Mk.IX wheels 5spoke 1/24 Airfix

Brassin set - the undercarriage wheels for Spitfire Mk.IXc in 1/24 scale. The set consists of the main wheels and tail wheel. Easy to assemble, replaces plastic parts. Recommended kit: Airfix

Set contains:

- resin: 3 parts
- decals: no
- photo-etched details: yes
- painting mask: yes



635029 WWII German lamp headlights PRINT 1/35

Brassin set - lamp headlights for German WWII AFV in 1/35 scale. The set consists of 12 headlights of 2 types (6+6). Made by direct 3D printing.

Set contains:

- 3D print: 24 parts
- decals: no
- photo-etched details: no
- painting mask: no



635030 WWII German crowbars PRINT 1/35

Brassin set - crowbars for German WWII AFV in 1/35 scale. The set consists of 6 crowbars. Made by direct 3D printing.

Set contains:

- 3D print: 6 parts
- decals: no
- photo-etched details: no
- painting mask: no



635031 WWII German starter crank handles PRINT 1/35

Brassin set - crank handles for German WWII AFV in 1/35 scale. The set consists of 3 crank handles. Made by direct 3D printing.

Set contains:

- 3D print: 3 parts
- decals: no
- photo-etched details: no
- painting mask: no

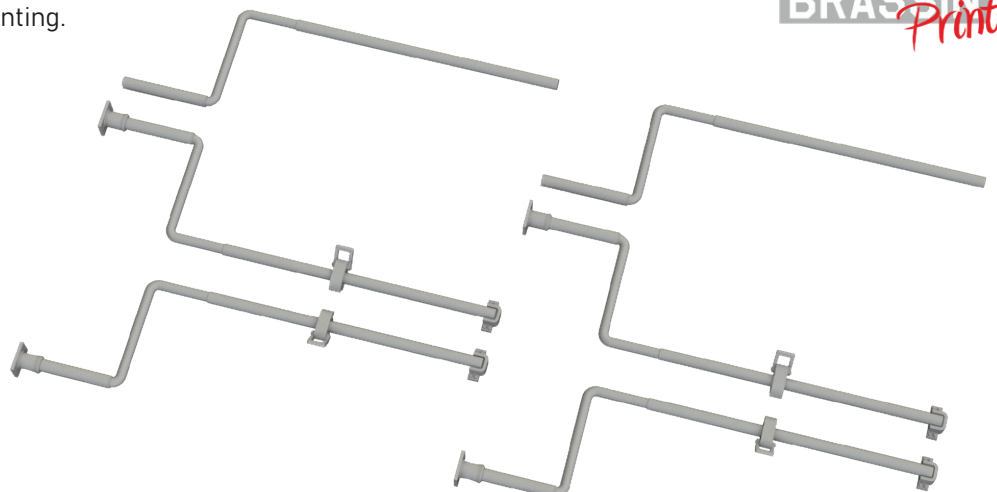

635032 WWII German pickaxes PRINT 1/35

Brassin set - pickaxes for German WWII AFV in 1/35 scale. The set consists of 4 pickaxes. Made by direct 3D printing.

eduard
BRASSIN
Print

Set contains:

- 3D print: 4 parts
- decals: no
- photo-etched details: no
- painting mask: no



648725 Sopwith Camel 2F.1 Lewis gun PRINT 1/48 Eduard

Brassin set - the gun for Camel 2F.1 in 1/48 scale. Made by direct 3D printing. Recommended kit: Eduard

Set contains:

- 3D print: 13 parts
- decals: no
- photo-etched details: no
- painting mask: no



eduard
BRASSIN
Print

648824 Fw 190F-8 cockpit PRINT 1/48 Eduard

Brassin set - cockpit for Fw 190F-8 in 1/48 scale. Made by direct 3D printing. Recommended kit: Eduard

Set contains:

- 3D print: 20 parts
- decals: yes
- photo-etched details: yes, pre-painted
- painting mask: no
- SPACE 3D decals: no

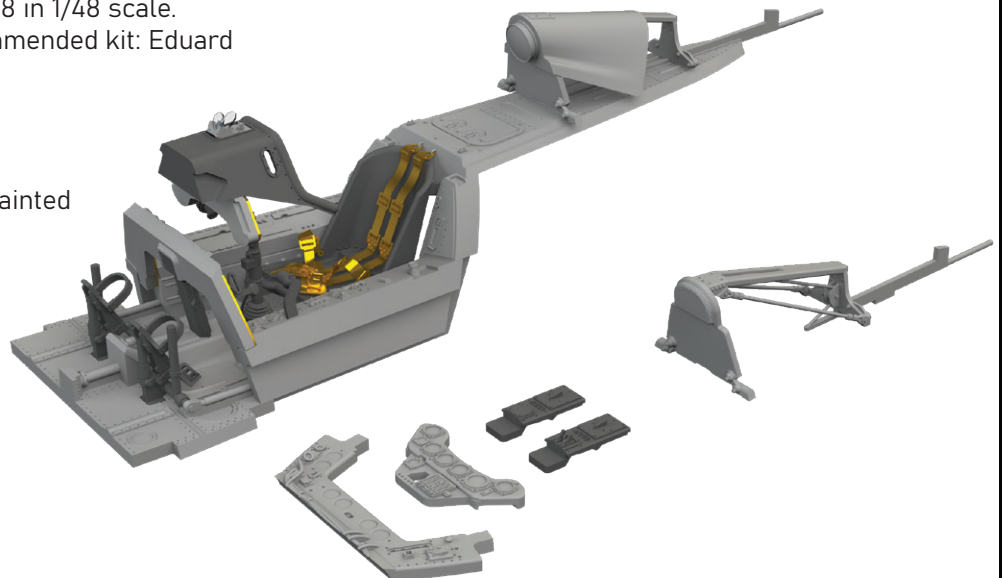

eduard
BRASSIN
Print

BACK

648825 F4F-3 engine mid PRINT 1/48 Eduard

Brassin set - the engine for F4F-3 in 1/48 scale. The cowlings are included. Made by direct 3D printing. Recommended kit: Eduard

Set contains:

- 3D print: 35 parts
- decals: no
- photo-etched details: yes
- painting mask: no

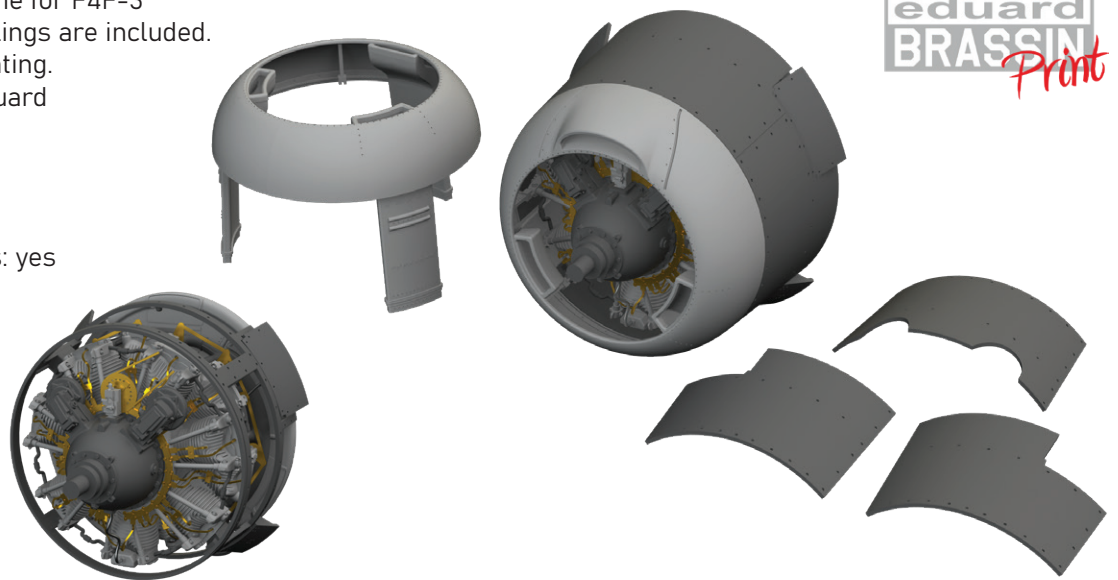

648843 Bf 109G-6 cockpit PRINT 1/48 Eduard

Brassin set - cockpit for Bf 109G-6 in 1/48 scale. Made by direct 3D printing. Recommended kit: Eduard

Set contains:

- 3D print: 21 parts
- decals: yes
- photo-etched details: yes, pre-painted
- painting mask: no
- SPACE 3D decals: no

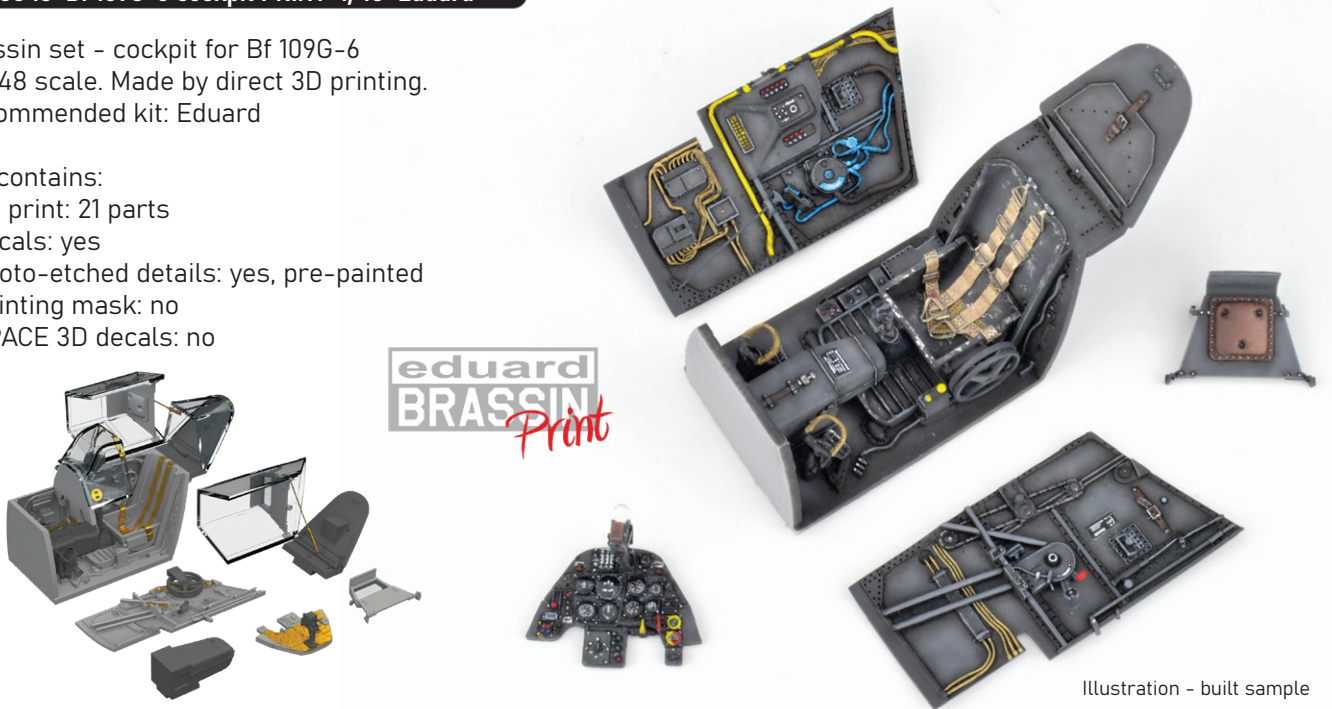

Illustration - built sample

648859 F-35A cockpit PRINT 1/48 Tamiya

Brassin set - cockpit for F-35A in 1/48 scale. Made by direct 3D printing. Recommended kit: Tamiya

Set contains:

- 3D print: 15 parts
- decals: yes
- photo-etched details: yes, pre-painted
- painting mask: no
- SPACE 3D decals: no

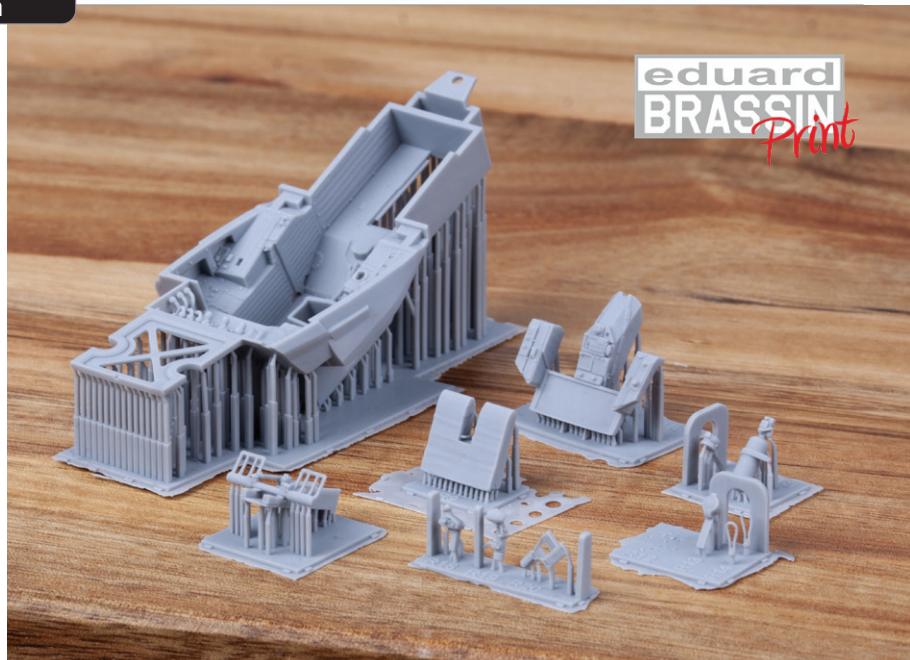
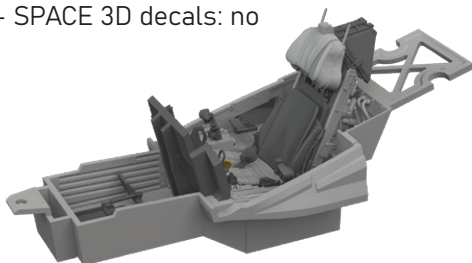

648862 Bf 110G radio equipment 1/48 Eduard

Brassin set - pre-painted radio equipment for Bf 110G in 1/48 scale. Recommended kit: Eduard

Set contains:

- resin: 3 parts
- decals: no
- photo-etched details: no
- painting mask: no

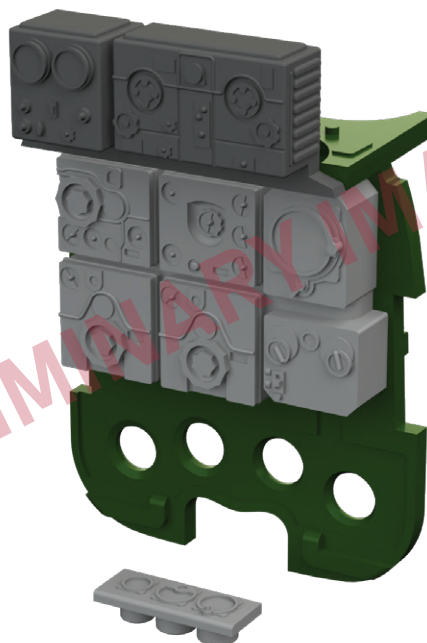

PRELIMINARY IMAGES

eduard
BRASSIN
Print

648863 B-25J wheels 1/48 HKM

Brassin set - the undercarriage wheels for B-25J in 1/48 scale. The set consists of the main wheels and a nose wheel. Easy to assemble, replaces plastic parts. Recommended kit: HKM

Set contains:

- resin: 3 parts
- decals: no
- photo-etched details: yes
- painting mask: yes

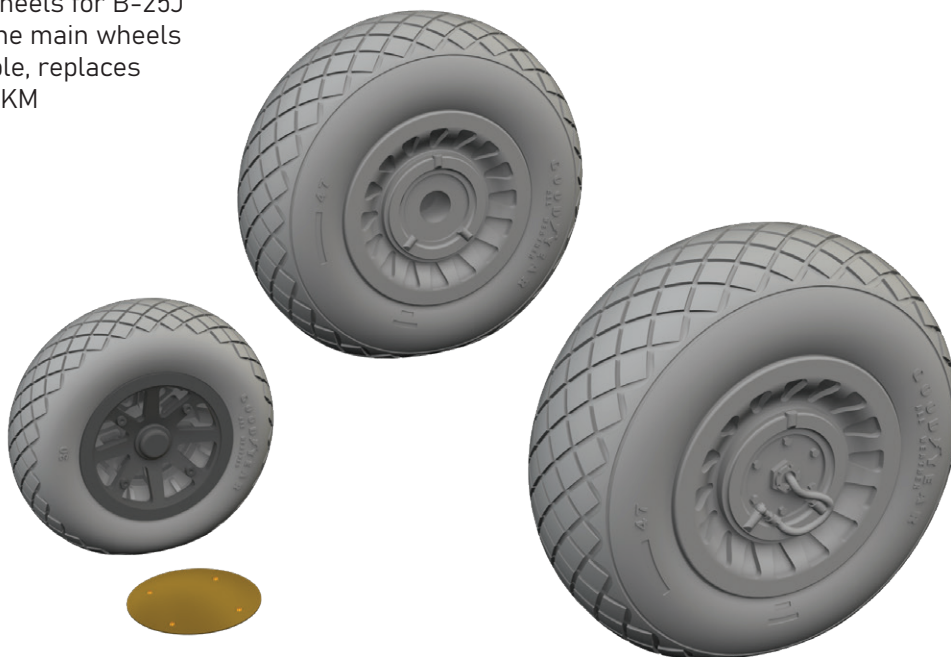

648864 Mi-8MT wheels 1/48 Zvezda

Brassin set - the undercarriage wheels for Mi-8MT in 1/48 scale. The set consists of the main wheels and nose wheels. Easy to assemble, replaces plastic parts. Recommended kit: Zvezda

Set contains:

- resin: 3 parts
- decals: no
- photo-etched details: no
- painting mask: yes



648865 Mi-17 wheels 1/48 AMK

Brassin set - the undercarriage wheels for Mi-17 in 1/48 scale. The set consists of the main wheels and nose wheels. Easy to assemble, replaces plastic parts. Recommended kit: AMK

Set contains:

- resin: 3 parts
- decals: no
- photo-etched details: no
- painting mask: yes



648867 Lewis 47-cartridges ammo magazines PRINT 1/48

Brassin set - ammunition magazines for Lewis guns in 1/48 scale. The set consists of 12 magazines. Made by direct 3D printing.

Set contains:

- 3D print: 12 parts
- decals: no
- photo-etched details: no
- painting mask: no

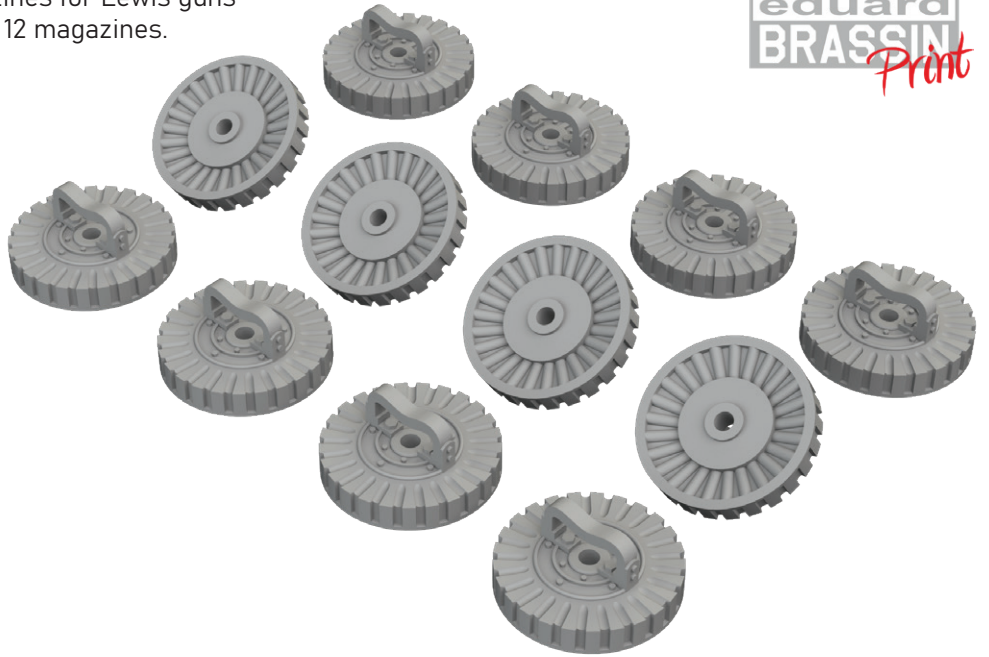

eduard
BRASSIN
Print

648869 F-16 ladder PRINT 1/48

Brassin set - the ladder for F-16 in 1/48 scale. Easy to assemble. Made by direct 3D printing.

Set contains:

- 3D print: 1 part
- decals: no
- photo-etched details: no
- painting mask: no

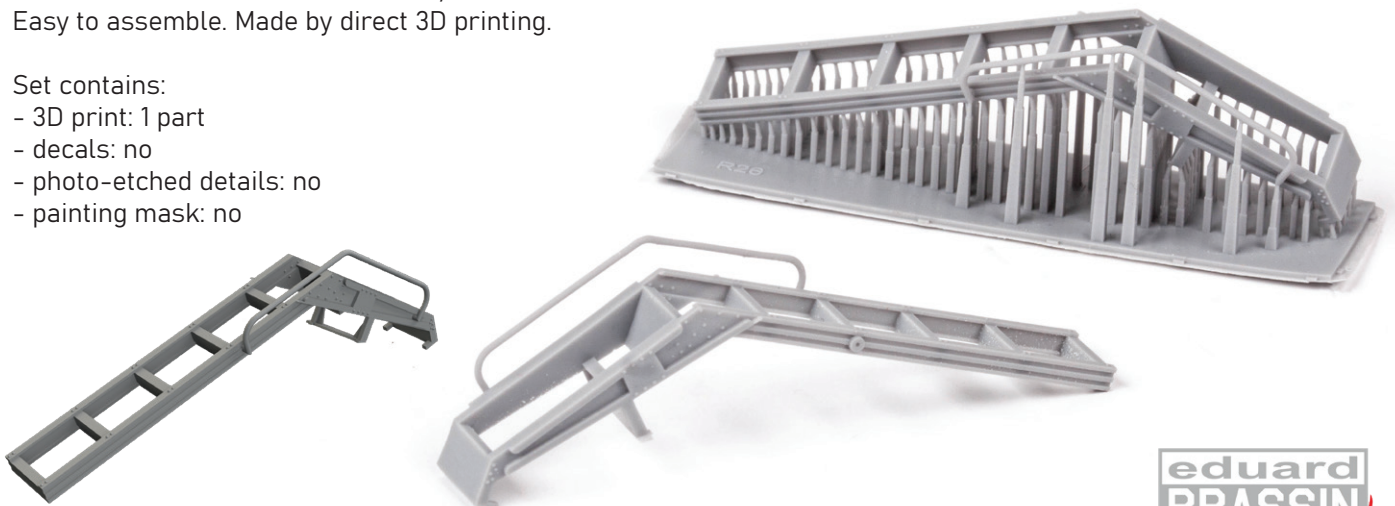

eduard
BRASSIN
Print

648870 B-25J engines PRINT 1/48 HKM

Brassin set - two engines for B-25J in 1/48 scale.
The cowlings are not included. Made by direct 3D printing.
Recommended kit: HKM

eduard
BRASSIN
Print

Set contains:

- 3D print: 8 parts
- decals: no
- photo-etched details: yes
- painting mask: no

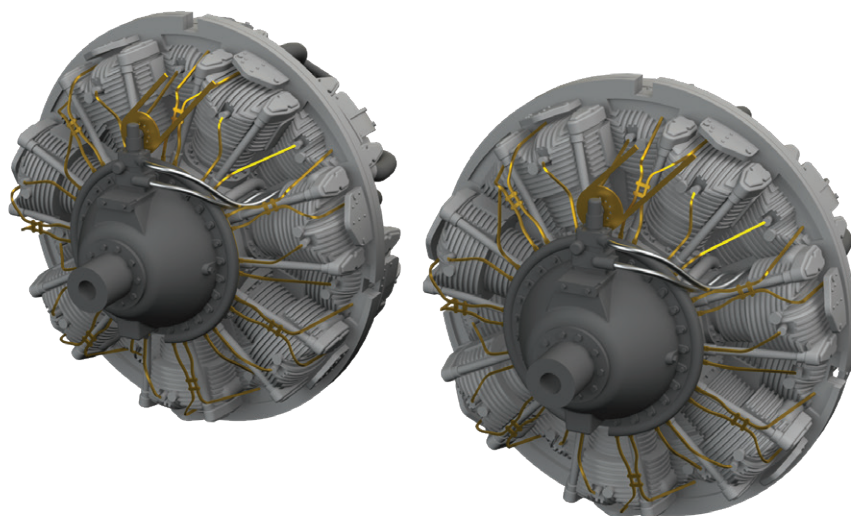

648871 B-25J bombsight PRINT 1/48 HKM

Brassin set - gunsight Norden type for B-25J
in 1/48 scale. Made by direct 3D printing.
Recommended kit: HKM

Set contains:

- 3D print: 1 part
- decals: no
- photo-etched details: no
- painting mask: no

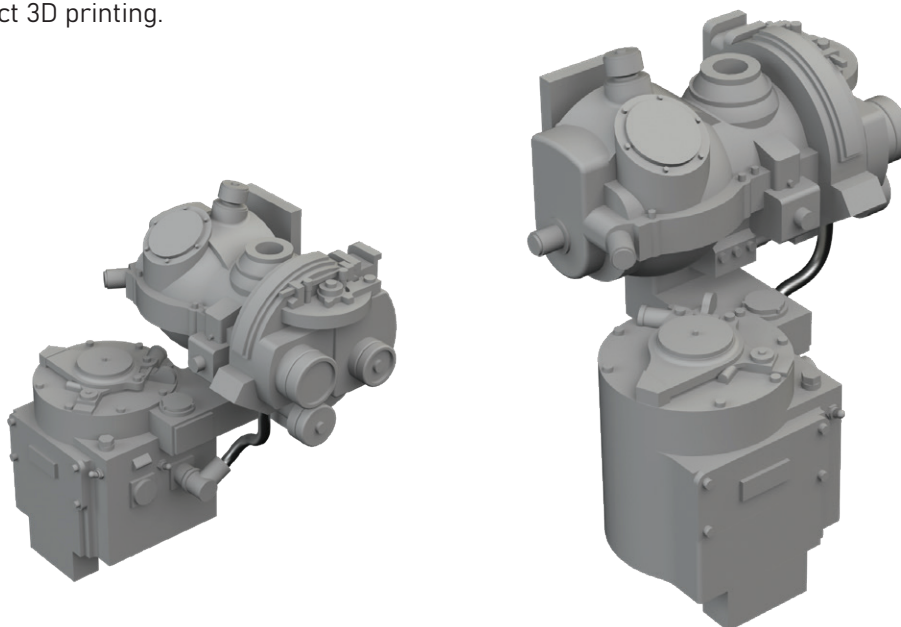

eduard
BRASSIN
Print

672313 Bf 109F propeller early PRINT 1/72 Eduard

Brassin set - the propeller for Bf 109F
in 1/72 scale. The spinner could be removed.
Recommended kit: Eduard

eduard
BRASSIN
Print

Set contains:

- 3D print: 6 parts
- decals: no
- photo-etched details: no
- painting mask: no

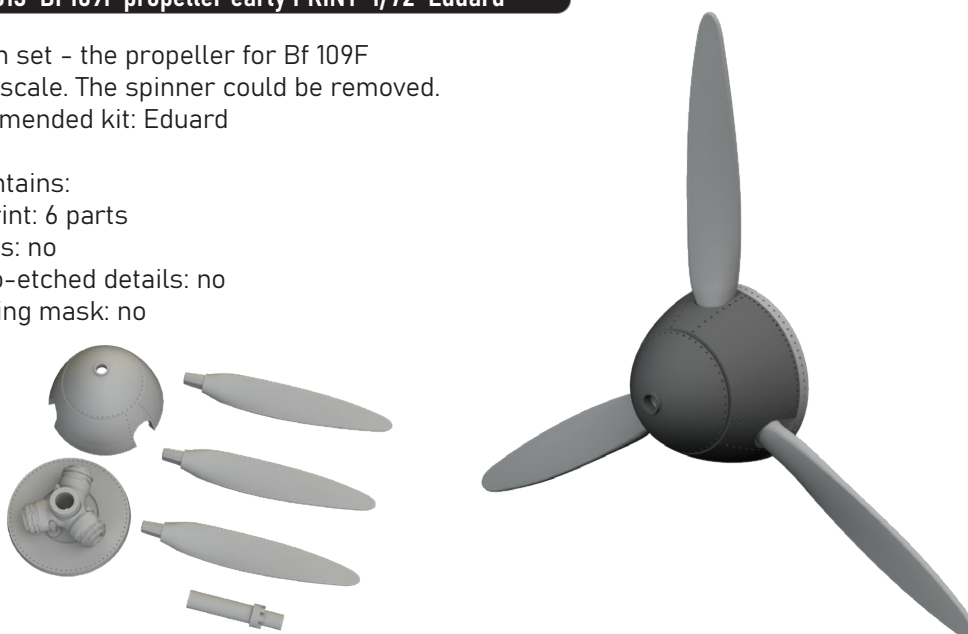

672314 Bf 109F propeller late PRINT 1/72 Eduard

Brassin set - the propeller for Bf 109F in 1/72 scale. The spinner could be removed. Recommended kit: Eduard

Set contains:

- 3D print: 6 parts
- decals: no
- photo-etched details: no
- painting mask: no

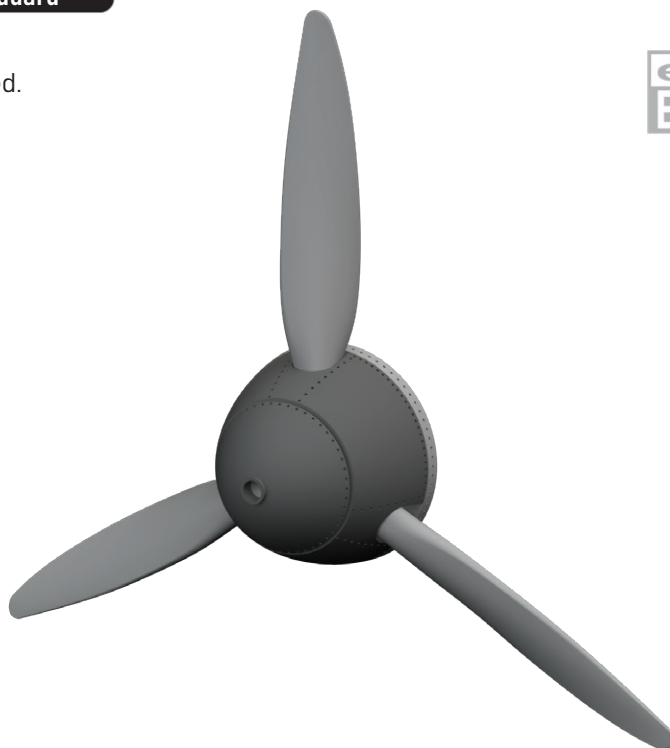
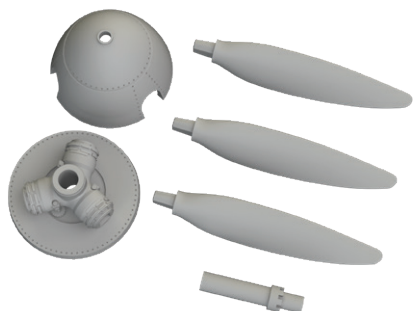

eduard
BRASSIN
Print

672315 Bf 109F gun barrels PRINT 1/72 Eduard

Brassin set - fuselage gun barrels for Bf 109F in 1/72 scale. Made by direct 3D printing. Recommended kit: Eduard

Set contains:

- 3D print: 1 part
- decals: no
- photo-etched details: yes
- painting mask: no



eduard
BRASSIN
Print

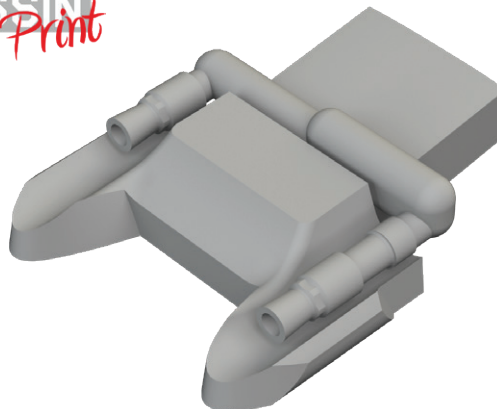

672316 Bf 109F wheels PRINT 1/72 Eduard

Brassin set - the undercarriage wheels for Bf 109F in 1/72 scale. The set consists of the main wheels and a tail wheel. Easy to assemble, replaces plastic parts. Recommended kit: Eduard

Set contains:

- resin: 3 parts
- decals: no
- photo-etched details: no
- painting mask: yes

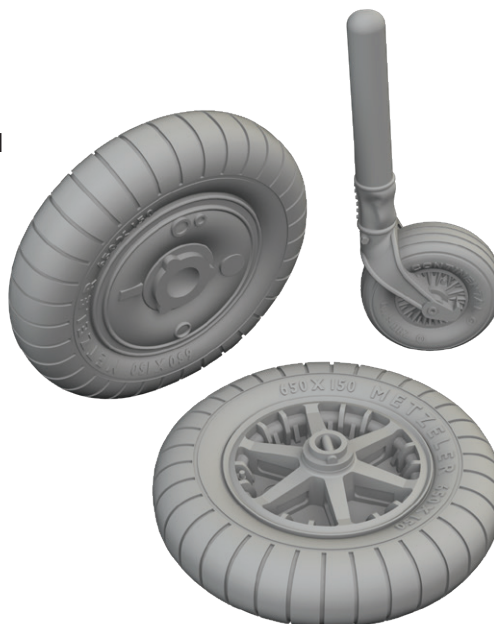

eduard
BRASSIN
Print

634035 Hurricane Mk.IIb w/ rounded exhausts LööKplus 1/32 Revell

Collection of 4 sets for Hurricane Mk.IIb in 1/32 scale.

Recommended kit: Revell

- LööK set (pre-painted Brassin dashboards & Steelbelts)
- TFace painting mask
- undercarriage wheels
- exhaust stacks

LööK+

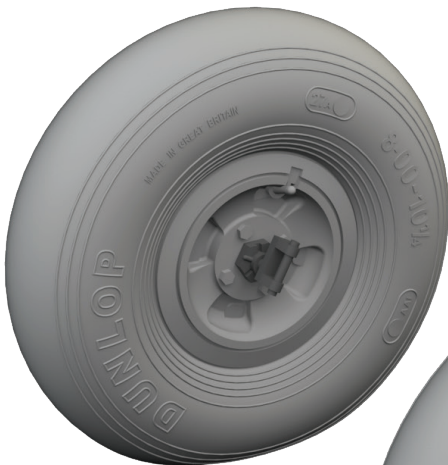
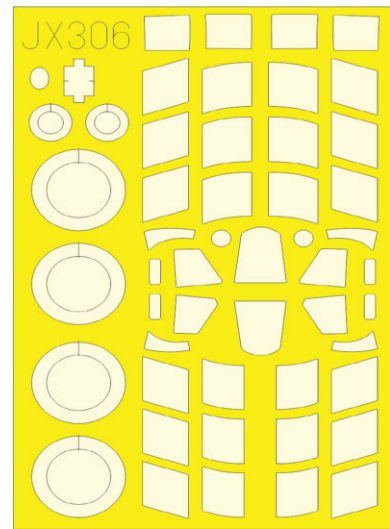
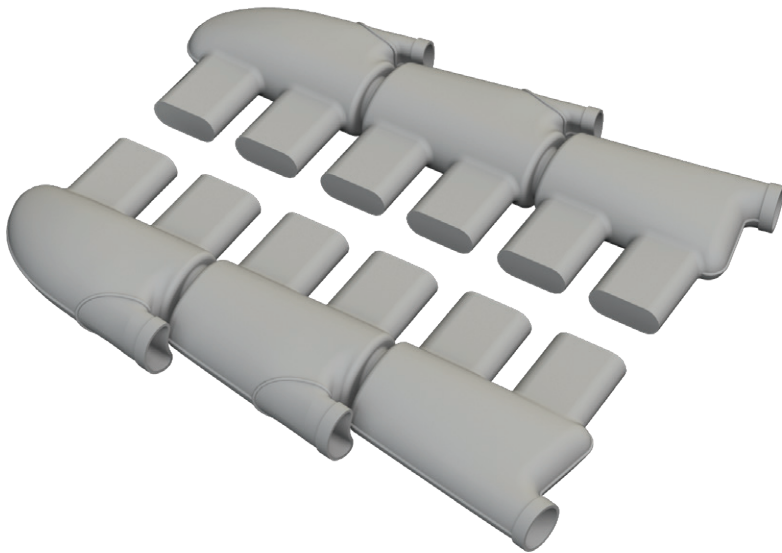
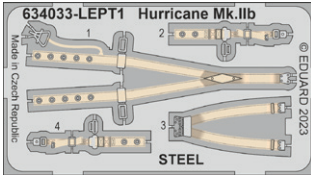

634037 Hurricane Mk.IIb w/ fishtail exhausts LööKplus 1/32 Revell

Collection of 4 sets for Hurricane Mk.IIb in 1/32 scale.
Recommended kit: Revell

- LööK set (pre-painted Brassin dashboards & Steelbelts)
- TFace painting mask
- undercarriage wheels
- exhaust stacks

Löökt

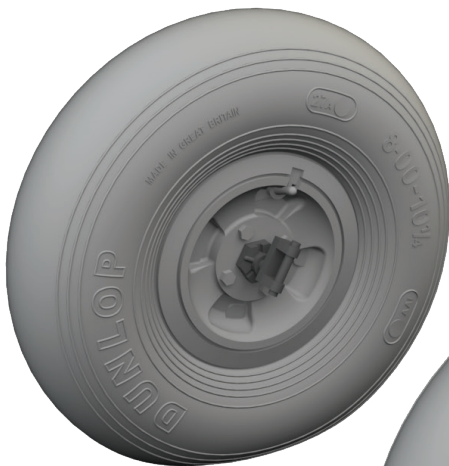
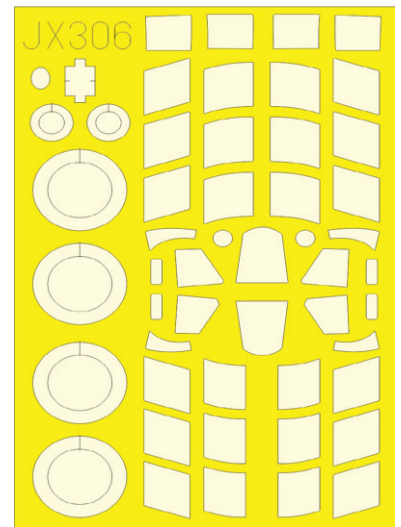
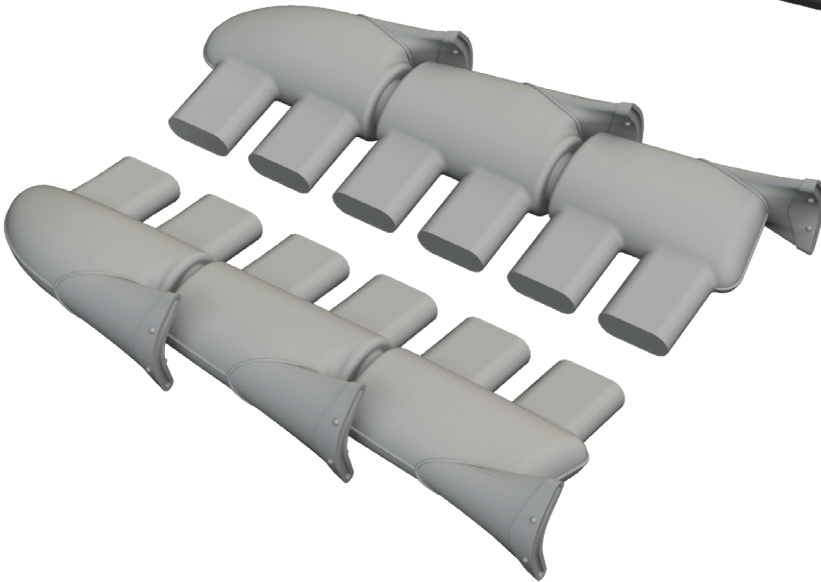
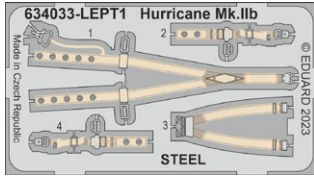

644214 F-16A MLU LööKplus 1/48 Kinetic

Collection of 4 sets for F-16A MLU in 1/48 scale.
Recommended kit: Kinetic

- LööK set (pre-painted Brassin dashboards & Steelbelts)
- TFace painting mask
- undercarriage wheels
- ejection seat

LööK+

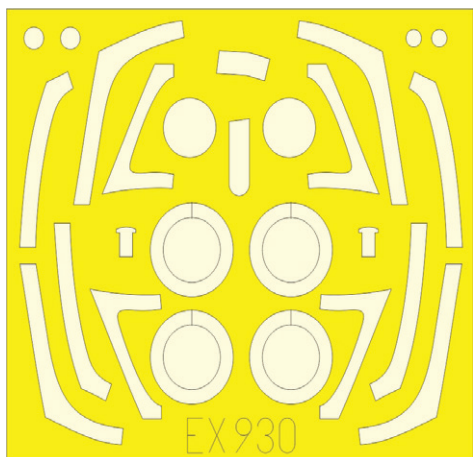
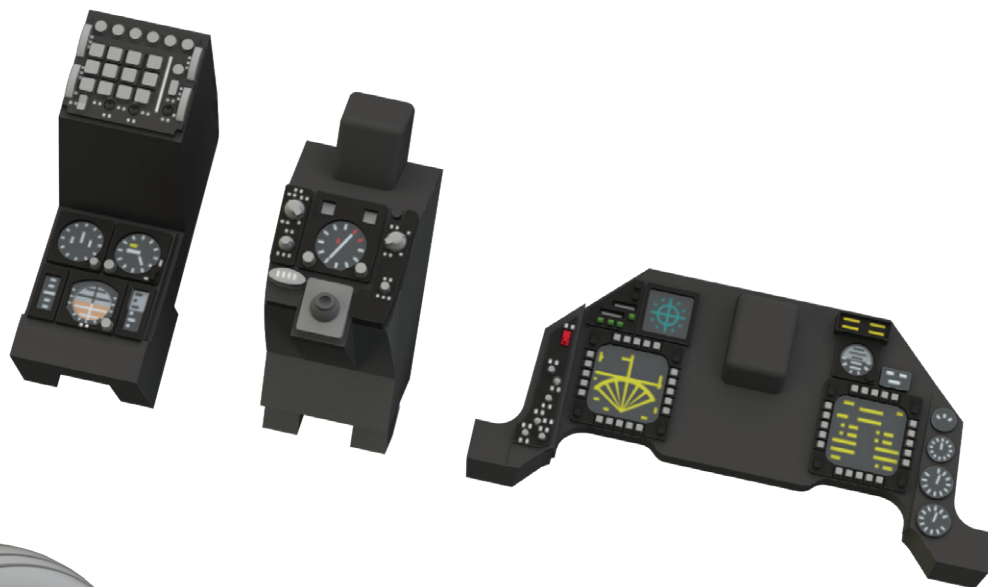

SIN648105 F4F-3 w/ early engine ADVANCED 1/48 Eduard

Collection of 4 sets for F4F-4 in 1/48 scale.
Recommended kit: Eduard

- engine
- gun bays
- landing flaps
- wheel bay

All sets included in this BIG SIN are available separately,
but with every BIG SIN set you save up to 30%.

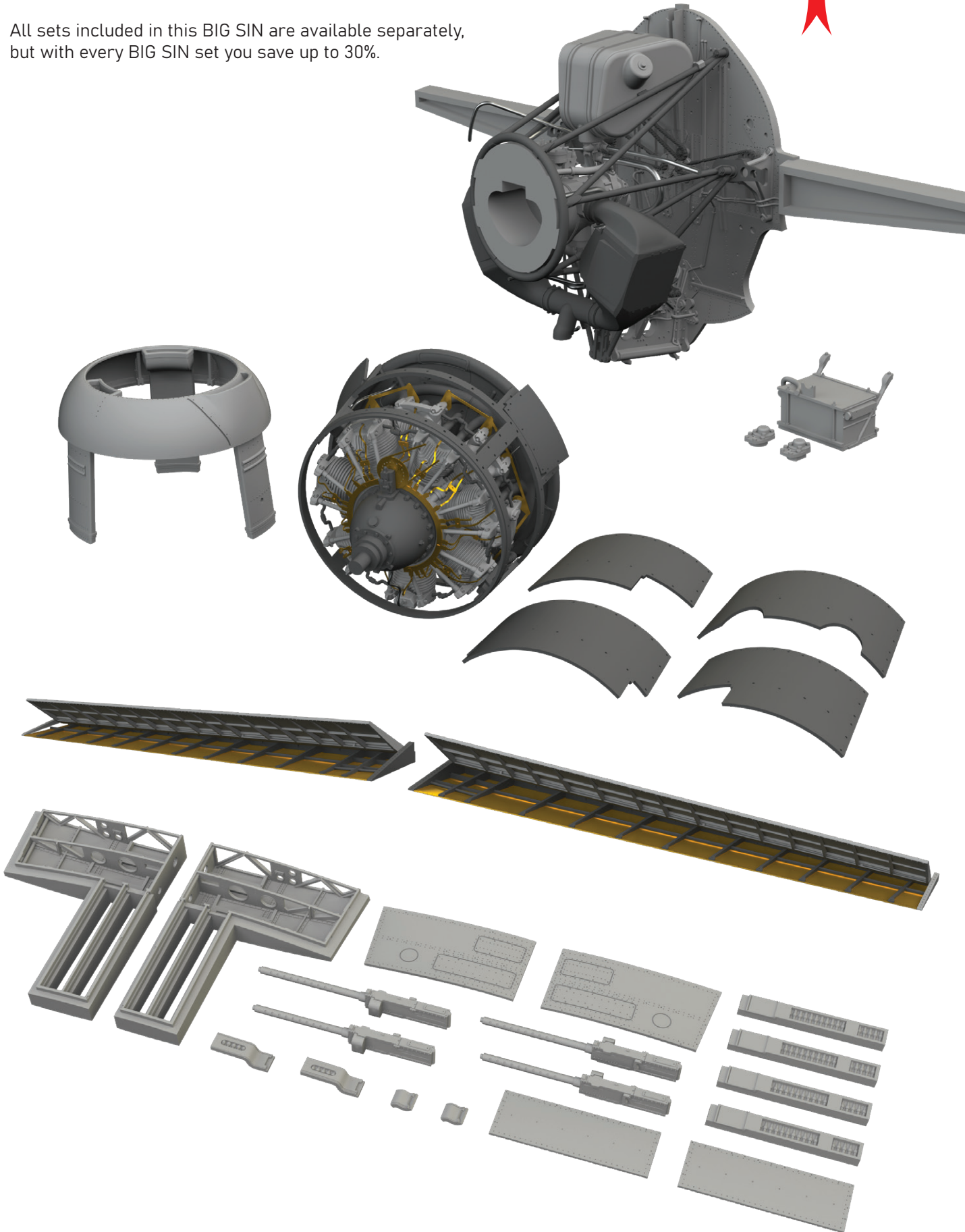

SIN648106 F-16 armament w/ Maverick missiles 1/48 Kinetic

Collection of 5 sets for F-16 in 1/48 scale.
Recommended kit: Kinetic

- AN/AAQ-13 LANTIRN pod
- AN/AAQ-14 LANTIRN pod
- AGM-65 Maverick (2 sets)
- AIM-9M/L Sidewinder

All sets included in this BIG SIN are available separately,
but with every BIG SIN set you save up to 30%.

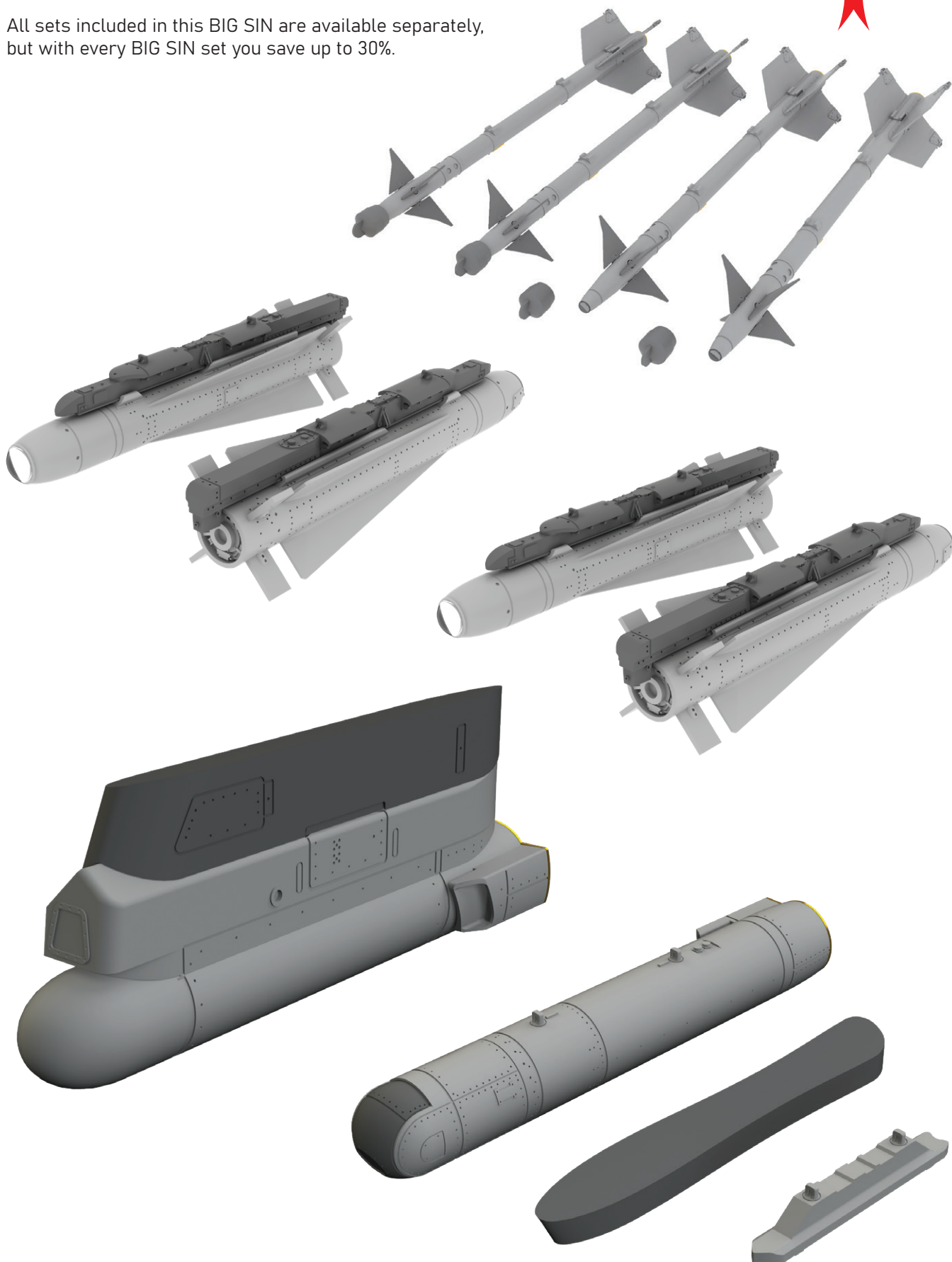

BIG33151 Hurricane Mk.IIb 1/32 Revell

- 32481 Hurricane Mk.IIb landing flaps 1/32
- 321006 Hurricane Mk.IIb 1/32
- 33344 Hurricane Mk.IIb seatbelts STEEL 1/32
- JX305 Hurricane Mk.IIb 1/32

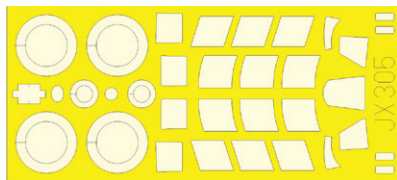
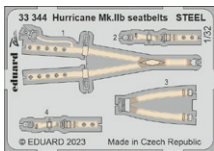
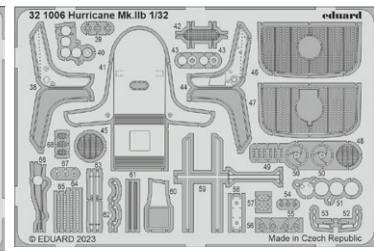
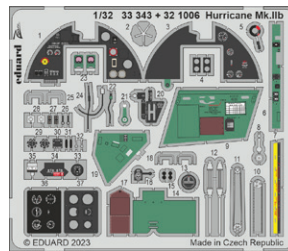
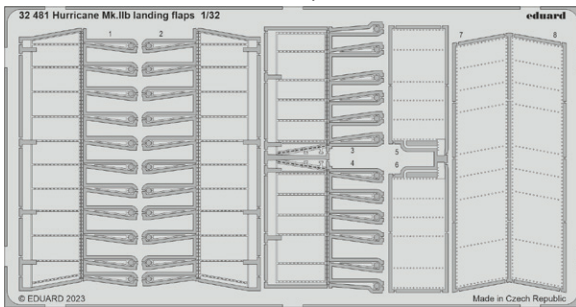

BIG49367 F-16A MLU 1/48 Kinetic

- 49103 Remove Before Flight STEEL
- 491334 F-16A MLU 1/48
- FE1335 F-16A MLU seatbelts STEEL 1/48
- EX929 F-16A MLU 1/48

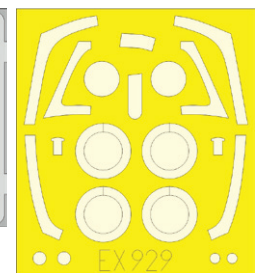
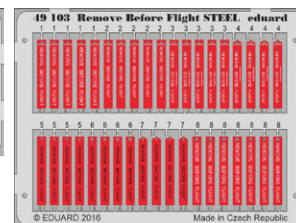
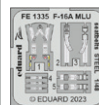
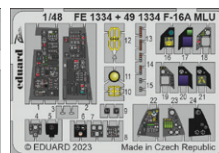
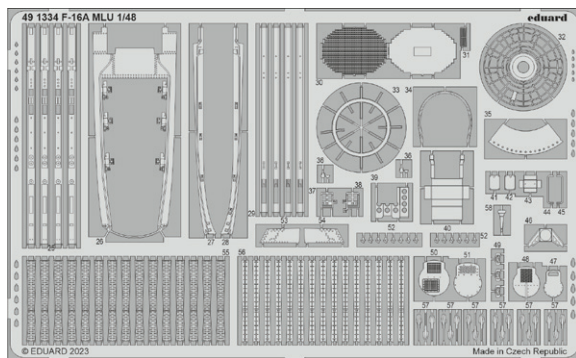

BIG49368 B-25J glazed nose 1/48 HKM

- 481101 B-25J bomb bay 1/48
- 491336 B-25J glazed nose 1/48
- FE1337 B-25J glazed nose seatbelts STEEL 1/48
- EX925 B-25J glazed nose 1/48

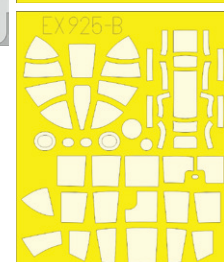
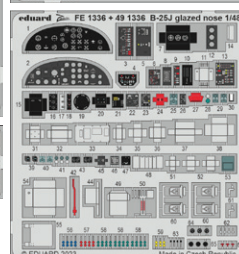
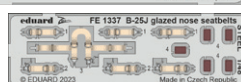
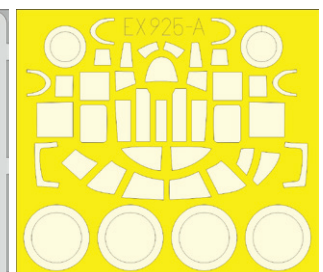
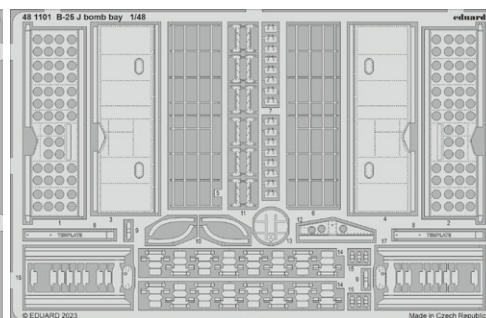
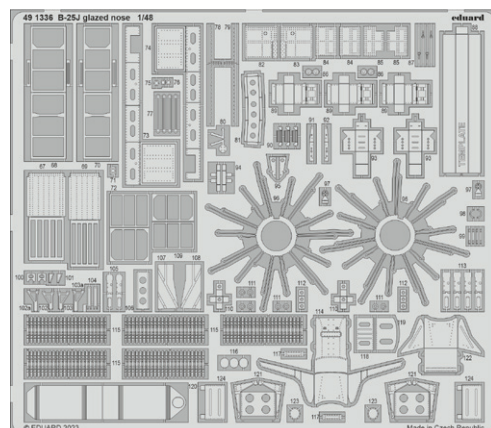

BIG49369 F-35A 1/48 Tamiya

- 49103 Remove Before Flight STEEL
- 491332 F-35A 1/48
- FE1333 F-35A seatbelts STEEL 1/48
- EX921 F-35A 1/48

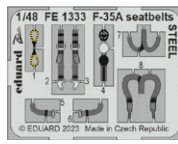
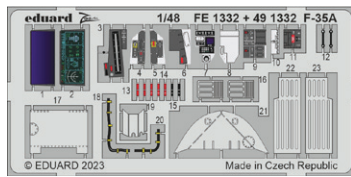
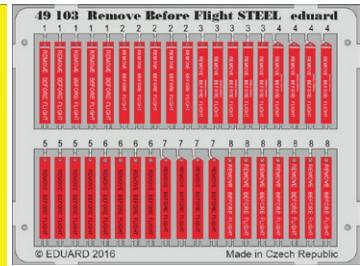
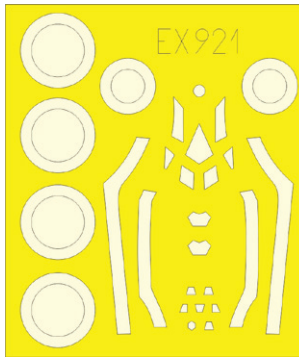
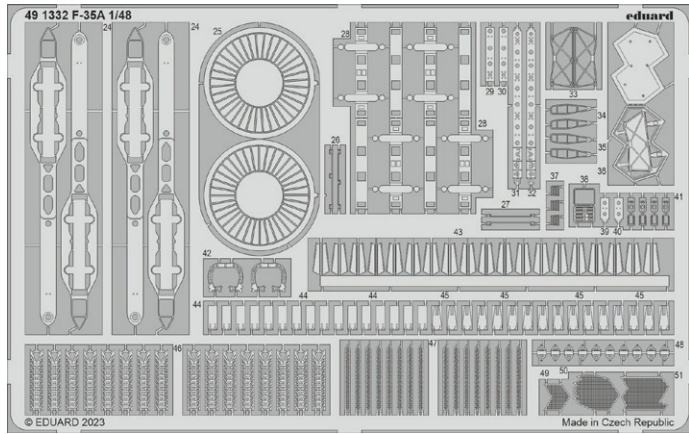

BIG72173 C-130J PART I 1/72 Zvezda

- 72728 C-130J exterior 1/72
- 73794 C-130J interior 1/72
- SS794 C-130J 1/72

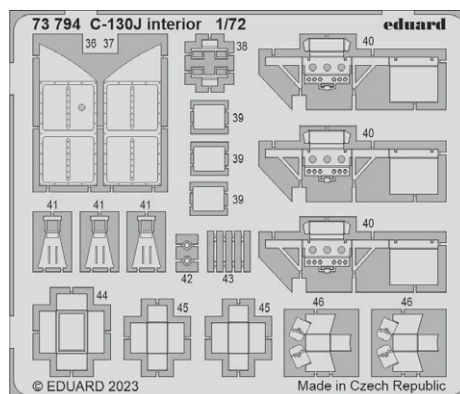
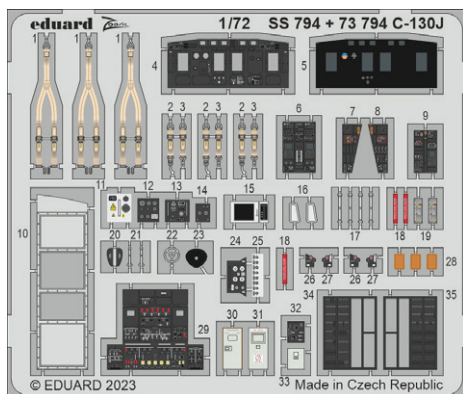
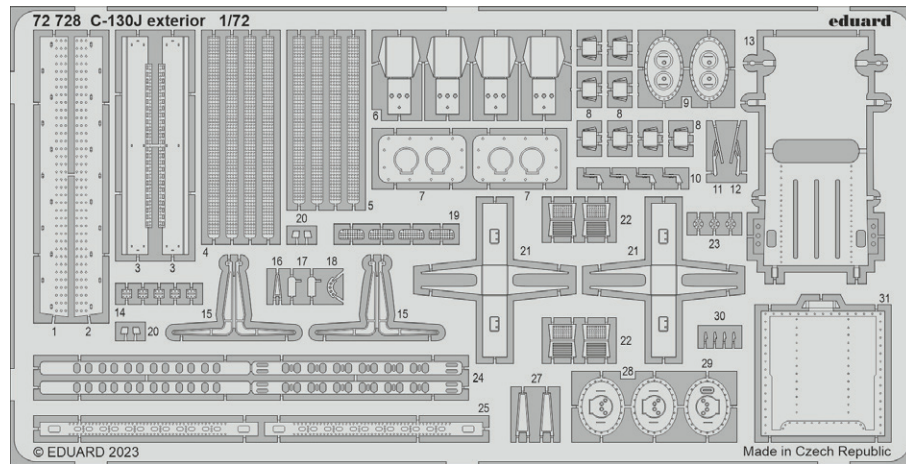

#624003

Spitfire Mk.IX exhaust fishtail PRINT

1/24 Airfix



Brassin set - exhaust stacks for Spitfire Mk.IXc in 1/24 scale. Made by direct 3D printing. Easy to assemble, replaces plastic parts. Recommended kit: Airfix

Set contains:

- 3D print: 12 parts
- decals: no
- photo-etched details: no
- painting mask: no



#634034

Spitfire Mk.IXc LööK

1/24 Airfix



LööK set - Brassin pre-painted dashboard and STEEL seatbelts for Spitfire Mk.IXc in 1/24 scale. Easy to assemble, replaces plastic parts. Recommended kit: Airfix

Set contains:

- resin: 1 part
- decals: no
- photo-etched details: yes, pre-painted
- painting mask: no

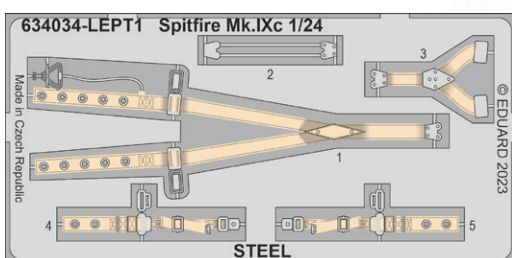

#648853

F4F-4 gun bays PRINT

1/48 Eduard



Brassin set - gun bays for F4F-4 in 1/48 scale.
The set consists of gun bays for both wings.
Made by direct 3D printing. Recommended kit: Eduard

Set contains:

- 3D print: 26 parts
- decals: no
- photo-etched details: yes
- painting mask: no

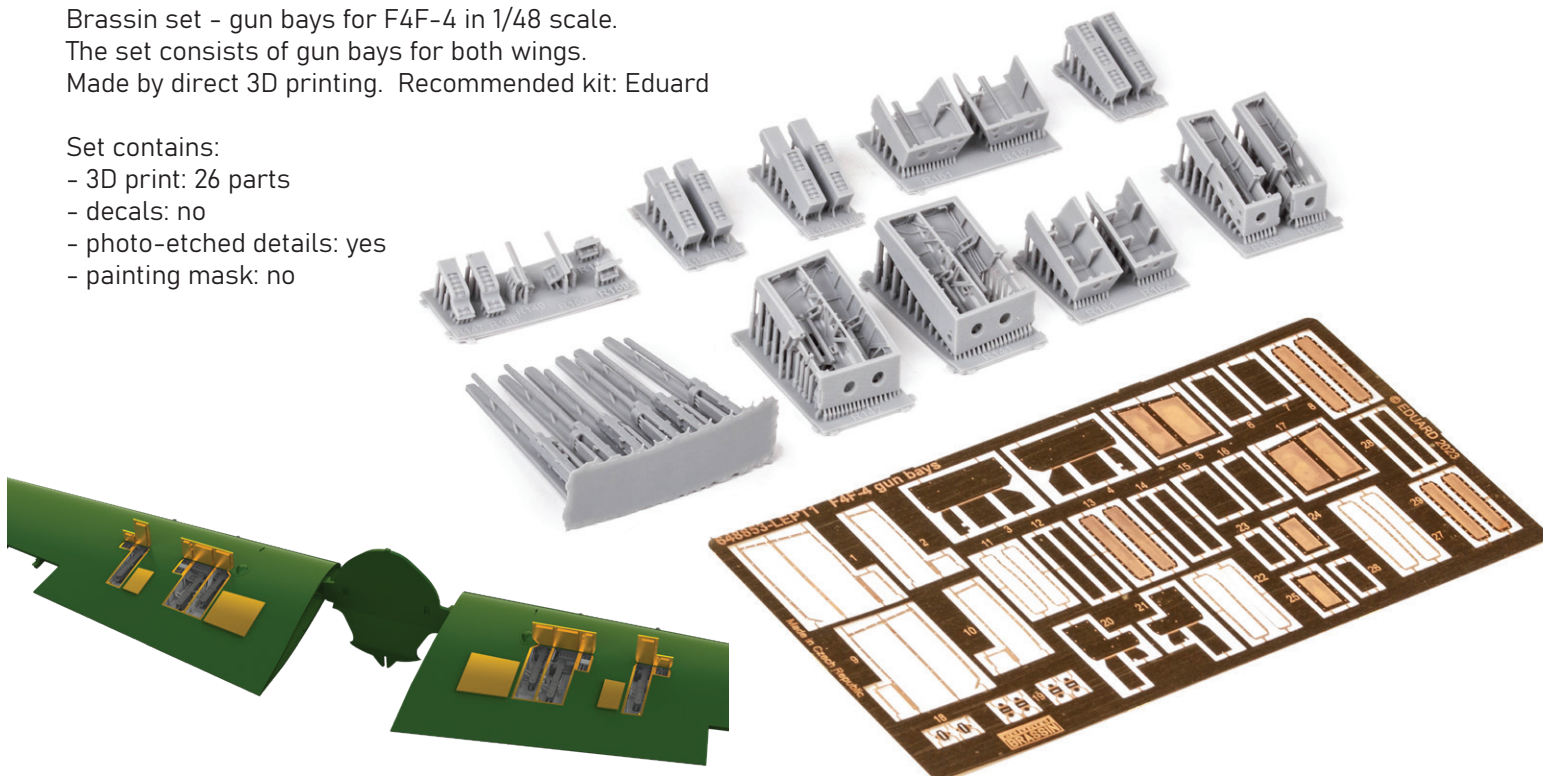

#648858

F-35A ejection seat PRINT

1/48 Tamiya

Brassin set - ejection seat for F-35A
in 1/48 scale. Easy to assemble,
replaces plastic parts. Made by direct
3D printing. Recommended kit: Tamiya

Set contains:

- 3D print: 9 parts
- decals: yes
- photo-etched details: yes, pre-painted
- painting mask: no

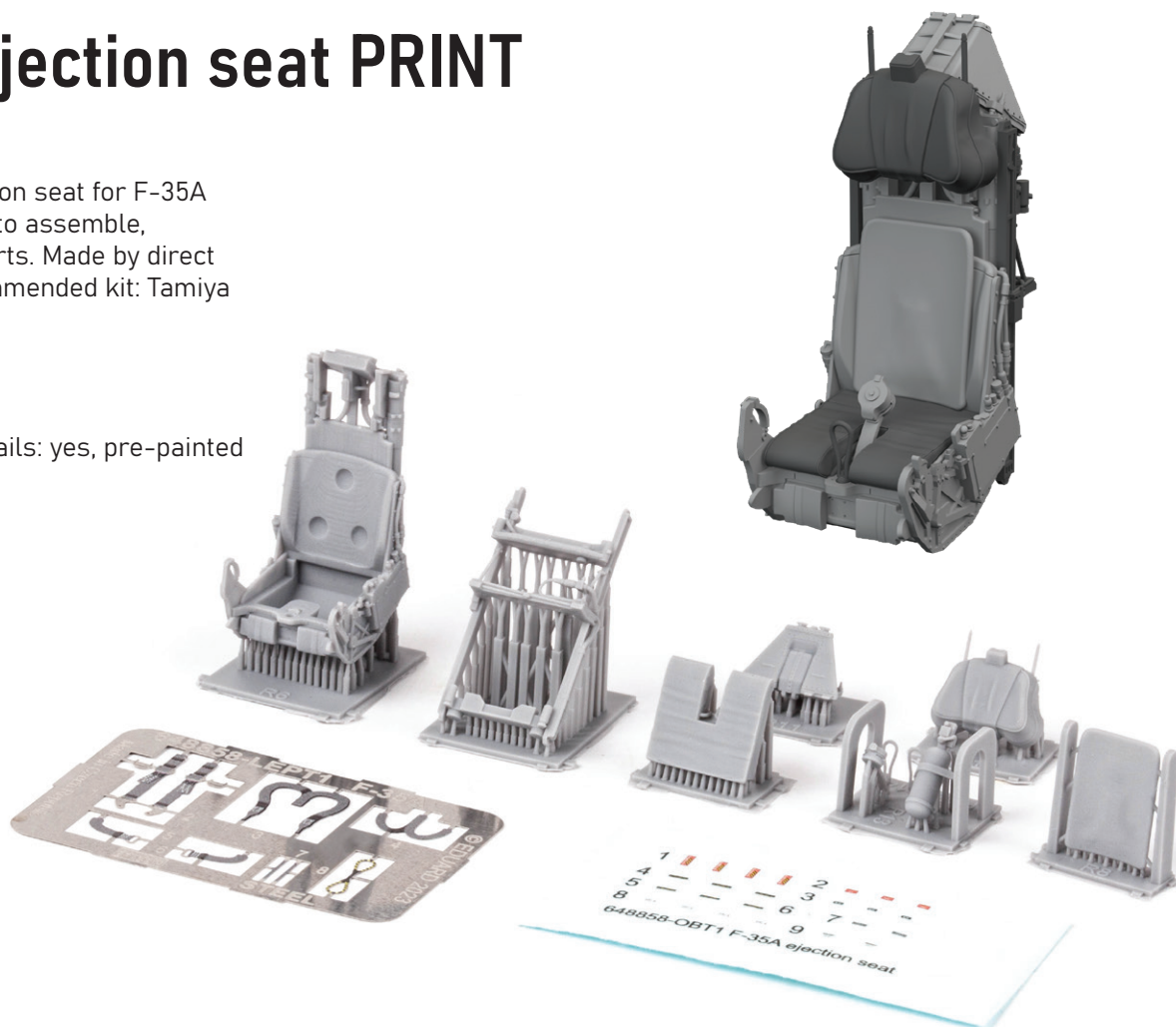

#648860

F-35A exhaust nozzle PRINT

1/48 Tamiya



Brassin set - exhaust nozzle for F-35A in 1/48 scale. Made by direct 3D printing. Easy to assemble, replaces plastic parts. Recommended kit: Tamiya

Set contains:

- 3D print: 4 parts
- decals: no
- photo-etched details: no
- painting mask: no

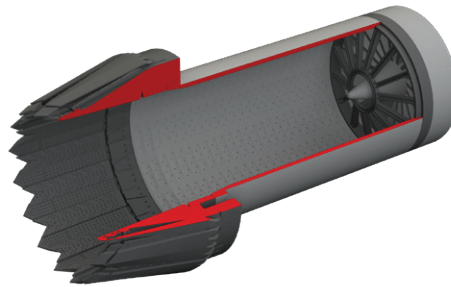

#3DL48118

P-400 SPACE

1/48 Eduard

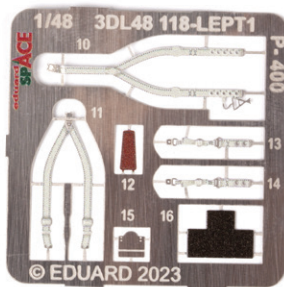
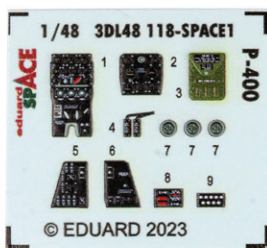

#3DL48119
Mi-17 SPACE
1/48 AMK

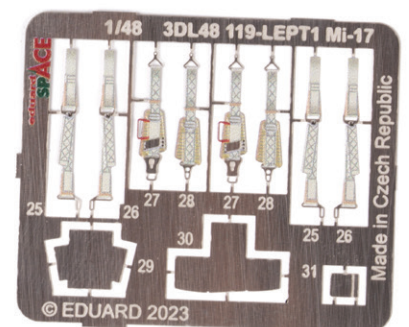
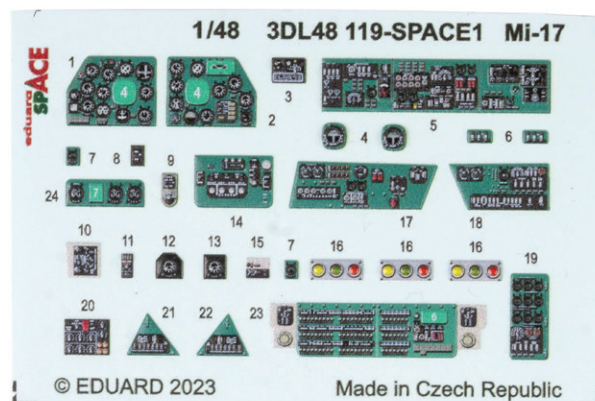

#D48112

Angel of Mercy

1/48 HKM



B-25J-10-NC, 43-35982, 428th BS, 310th BG, 12th AF, Ghisonaccia, Corsica, France, April 1945

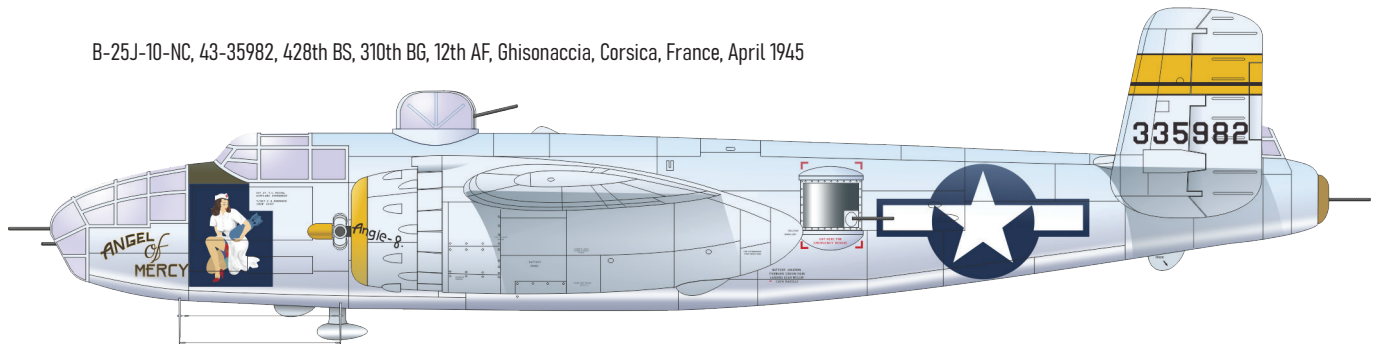

B-25J-1-NC, 43-27716, 445th BS, 321st BG 12th AF, Solenzara, Corsica, France, April 1945

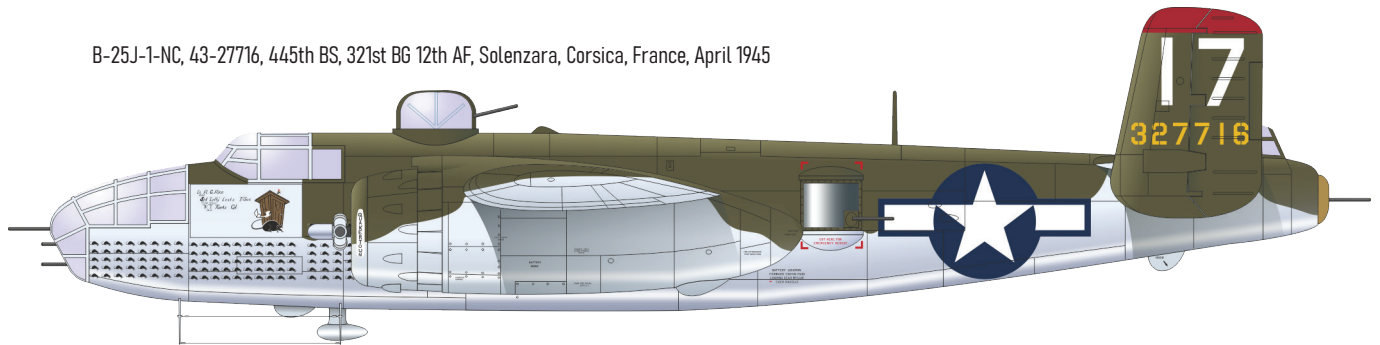

B-25J-1-NC, 43-3890, 82nd BS, 12th BG, 10th AF, Fenny, India, December 1945

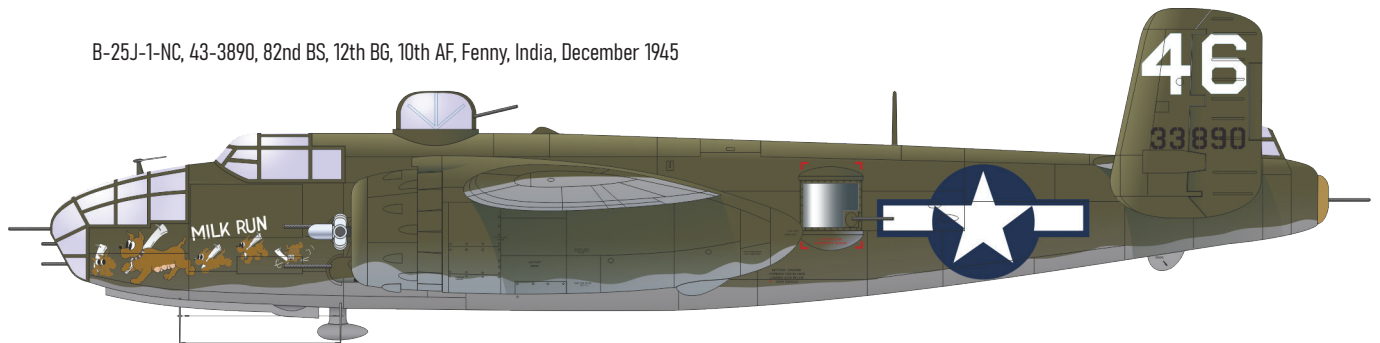

B-25J-10-NC, 43-36020, 501st BS, 345th BG, 5th AF, Tacloban, Philippines, April 1945

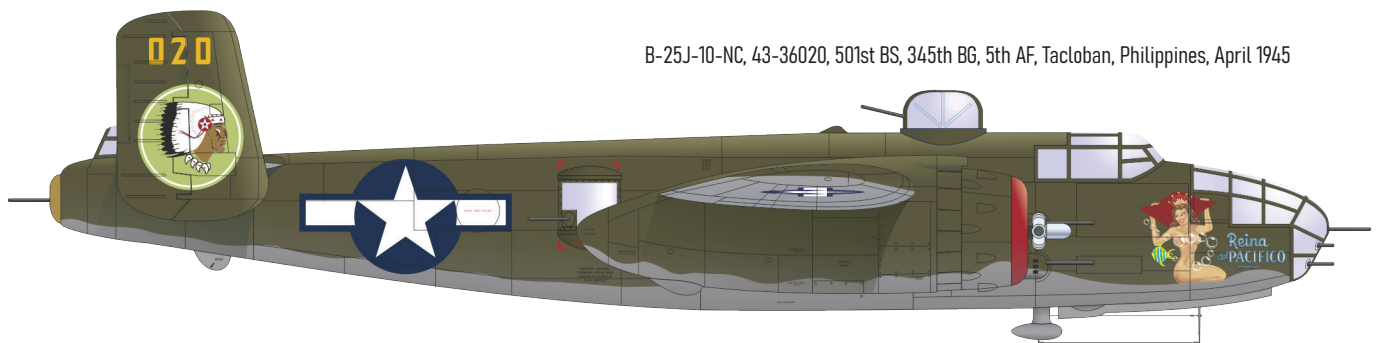

B-25J-5, 43-27952, 823rd BS, 38th BG, 5th AF, Morotai, Indonesia, November 1944

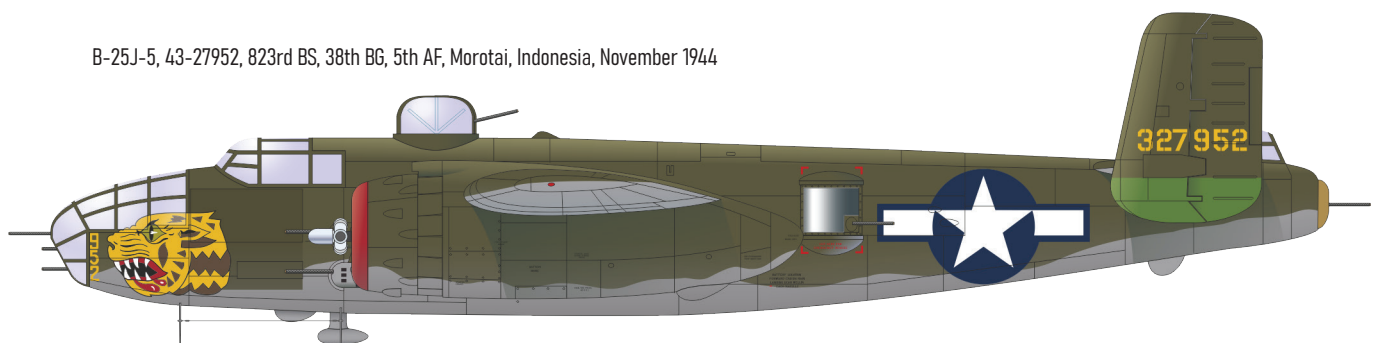



Spitfire Story: Malta

1/48

WILD CARDS 



AB264, F/O Robert W. McNair, No. 249 Squadron, RAF Ta Kali, Malta, March 1942



EP122, Sgt. Claude Weaver III, No. 185 Squadron, RAF Ta Kali, Malta, July 1942



EP706, P/O George F. Beurling, No. 249 Squadron, RAF Ta Kali, Malta, August - October 1942



EP829, S/Ldr John J. Lynch, No. 249 Squadron, RAF Qrendi, Malta, February - May 1943



ER647, S/Ldr John R. Urwin-Mann, No. 126 Squadron, RAF Luqa, Malta, Spring 1943



ER187, Maj. Frank A. Hill, 309th FS, 31st FG, Xewkija, Gozo - Malta, early July 1943



ER187, Maj. Frank A. Hill, 309th FS, 31st FG, Xewkija, Gozo - Malta, early July 1943



BP975, F/Lt Denis Barnham, No. 601 Squadron, RAF Luqa, Malta, April - May 1942



BR126, P/O Jerrald A. Smith, No. 126 Squadron, USS Wasp (CV-7), May 1942



BR311, F/Lt Roderick L. A. Smith, No. 126 Squadron, RAF Luqa, Malta, October 1942



BR321, F/Lt John A. Plagis, No. 185 Squadron, RAF Hal Far, Malta, June 1942



BR387, P/O John W. Yarra, No. 185 Squadron, RAF Hal Far, Malta, June 1942



BR498, W/Cdr Peter P. Hanks, Luqa Wing, Malta, August 1942 - February 1943



JK715, S/Ldr Evan D. Mackie, No. 243 Squadron, RAF Hal Far, Malta, June - July 1943



BR190, F/Sgt Virgil P. Brennan, No. 249 Squadron, RAF Ta Kali, Malta, May 1942

- RAF and USAAF Spitfire Mk.Vb and Mk.Vc in Mediterranean during the defence of Malta
- Focused on aircraft serving in period 1942-43
- Dual Combo - plastic parts, die cut masks and photo-etched details for two complete models
- Decals for 15 marking options

MAY 2023

DUAL COMBO #11172

WWW.EDUARD.COM