

INFORMATION FOR DISTRIBUTORS

# MAY 2023

Dear friends,

In today's Leaflet you will find the upcoming releases for May 2023.

## THE KITS

In May we will release four new kits as new items and two more that were released earlier and were not available for some time.

I'd say the most attention will be paid to Spitfire Story: Malta in 1/48 scale. This kit will be released as a Limited Edition Dual Combo with decals for the twelve machines that took part in the defense of this unsinkable aircraft carrier in the Mediterranean. The kit will include plastic parts for the Spitfire Mk.Vb and Vc. Of course, there will be no shortage of color schemes for the blue painted Spitfires. And the legends of the Malta defenders in this edition will be dominated by „Screwball“ Beurling and „Rose“ Mackie.

In the ProfiPACK edition in May we will release F6F-5 in 1/48 scale with camouflage schemes for six US Navy machines. These will include planes flown by successful fighter pilots from VF-9, VF-31, VF-17 and other units. The boxart will depict Eugene Valencia in combat over Japan in February 1945.

In the Weekend edition we will release a 1/72 scale MiG-21MF kit. As is customary with this series, it will include decals for four machines. In addition to the Czech or Soviet machine, there will also be a Somali Air Force plane.

In May we will also release a 1/48 scale Bf 109F-4 in the Weekend edition. It will offer decals for one machine from Western Europe, one from the Eastern Front, one from the fighting in Finland and will feature Hans-Joachim Marseille on its boxart with his „yellow 14“.

Reissue brings back to the range the long sought after Fokker Dr.I triplane kit in the ProfiPACK range in 1/48 scale. It will have a new boxart featuring the legendary Manfred von Richthofen's aircraft and will symbolically depict the situation in which he achieved his last, 80th victory. The second reissue, in the same series, will be a 1/72 scale Fw 190F-8, also with a new boxart.

## BRASSIN

First of all I would like to mention a 1/48 scale set for A6M2-N Rufe (Eduard) floatplane. In May we will release a cockpit as well as flaps and engine.

However, cockpit differs in detail from the cockpit for the classic A6M2 Type 21 Zero, which was the basis for the Rufe seaplane design.

In May, we will continue the 1/48 Wildcat theme, releasing an engine model for the F4F-3A and a set for the F4F-4 gunbays.

We will be covering the 1/48 scale F-35A kit by Tamiya with a set for the seat and exhaust nozzle. With the next four sets we will continue with the release of 1/48 scale F-16 accessories by Kinetic. This will be a radar and three sets of LööK for Falcons of different production blocks.

For the majestic 1/24th scale Spitfire Mk.IXc kit from Airfix we will release an exhausts and LööK set.

LööK will also be released for the new Revell Hurricane Mk.IIb in 1/32 scale.

In the LööKplus series we will release three 1/48 scale sets, A6M2-N Rufe (Eduard), Mosquito B.Mk.IV (Tamiya) and F-16C Block 25 (Kinetic).

There will be available an armament set for Kinetic's F-16 in the BIGsin series, and we will release a 1/48 scale set for the F4F-4 (Eduard) in the same series.

Modelers seem to like our generic accessories. That's why we continue with pedals for Luftwaffe aircraft in 1/32 scale, magazines for Vickers machine guns in 1/48 scale and two sets for German AFV combat equipment in 1/35 scale. These will be a set with ten lugs for tow ropes and a set with five binoculars.

## SPACE

In 1/32 scale we will release SPACE sets for the P-40B (GWH) and in 1/35 scale we will produce a set for the CH-54A helicopter (ICM). In 1/48 scale we will launch most of the new releases, namely the F-86D (Revell), Mi-17 (AMK/Annetra) and sets for Eduard, Bf 110C and P-400 kits. There is planned also a 1/72 scale set for Eduard kit for Spitfire Mk.IXc and B-25J (Hasegawa).

## DECALS

We will release a 1/48 scale decal sheet for the B-25J kit by HKM, which will be based on the decals that were part of the 1/72 Eduard kit released under the name „Angel of Mercy“.

## Photo-etched parts

In May we are planning to release several sets for

the new AMK and Annetra Mi-17 helicopter kit in 1/48 scale, including seat belts, cargo bay belts, cargo bay floor, etc.

For the A6M2-N Rufe kit in 1/48 scale (Eduard) we will also release the flaps in photo-etched form. Both 3D printed and etched solutions have their supporters.

For the P-40B in 1/32 scale (GWH) we will release a photo-etched set based on the previous set for the Hawk 81-A2.

Academy has released a 1/48 scale kit of the PV-1 bomber (Revell plastic parts). We have redesigned the original photo-etched sets produced earlier and will release them in a new form in May. It will be a set for cockpit, interior, exterior, landing gear, bomb bay and seatbelts made of steel.

Revell has put the F-86D kit back on sale in 1/48th scale and our designers are preparing all new sets for it.

The 1/35 "AFV" scale CH-54A helicopter kit is no small thing. Our photo-etched parts should make this ICM scale kit even more realistic.

In the Zoom series in 1/72 scale we will release a set for MiG-21MF (Weekend, edition, Eduard).

And in May, we'll follow up with a second set for the 1/350th scale USS Missouri (BB-63) battleship kit from Hobby Boss.

## Orders

We would welcome your pre-orders for May items by Friday, March 31, 2023. Thank you!

April items will be ready for shipping on Friday, 17 March.

In connection with the model show, which will be held in Prague on Saturday March 25, 2023 by KPM Prosek Panthers, there will be a several days discount event on our e-shop, in which we will start selling April novelties.

We are also sending folder with the graphics included in the Leaflet. Many of you are using our Leaflet images for pre-order section of your e-shops and in your newsletters. We hope this will save you some time.

If you would like get more information, clarify some points or if you would need our help, please contact us at [department@eduard.cz](mailto:department@eduard.cz) or contact me directly at [jan.bobek@eduard.cz](mailto:jan.bobek@eduard.cz).

Jan Bobek

Product previews are subject of change.

Instruction sheets,  
more pictures and information  
can be found on [www.eduard.com](http://www.eduard.com)

This leaflet can be downloaded from on [www.eduard.com](http://www.eduard.com)

**eduard**

## PLASTIC KITS



8229 **F6F-5 Hellcat late**  
1/48 ProfiPACK

DETAIL



11172 **SPITFIRE STORY: MALTA**  
1/48 Limited **DUAL COMBO**

DETAIL

NO PREVIEW

DETAIL

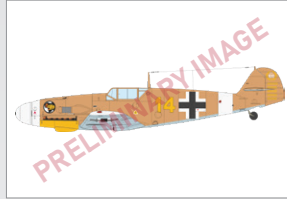

84188 **Bf 109F-4**  
1/48 Weekend edition

DETAIL



8162 **Fokker Dr.I**  
1/48 ProfiPACK **Re-release**

DETAIL



70119 **Fw 190F-8**  
1/72 ProfiPACK **Re-release**

DETAIL

## MASKS

JX307	CH-54A	1/35 ICM
JX308	CH-54A TFace	1/35 ICM
EX940	F-86D	1/48 Revell
EX941	F-86D TFace	1/48 Revell
EX942	Mi-17	1/48 AMK
EX943	Mi-17 TFace	1/48 AMK
EX944	PV-1	1/48 Academy
EX945	PV-1 TFace	1/48 Academy
EX946	Do 335A TFace	1/48 Tamiya

## SPACE

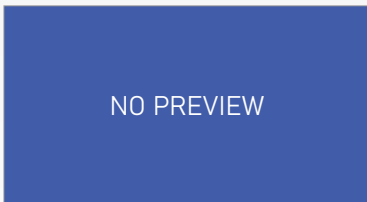

3DL32014 **P-40B SPACE**  
1/32 Great Wall Hobby  
(2 parts)

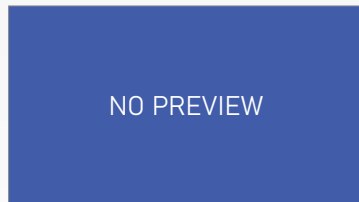

3DL32015 **CH-54A SPACE**  
1/35 ICM  
(2 parts)

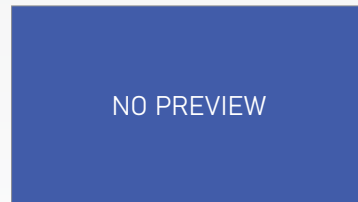

3DL48116 **F-86D SPACE**  
1/48 Revell  
(2 parts)

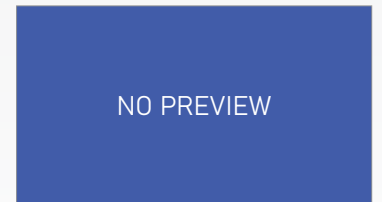

3DL48117 **Bf 110C SPACE**  
1/48 Eduard  
(2 parts)

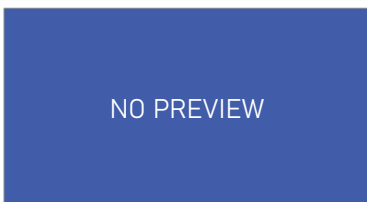

3DL48118 **P-400 SPACE**  
1/48 Eduard  
(2 parts)

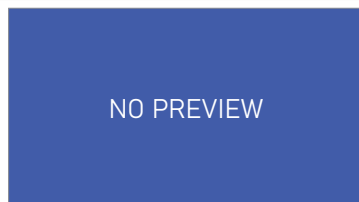

3DL48119 **Mi-17 SPACE**  
1/48 AMK  
(2 parts)

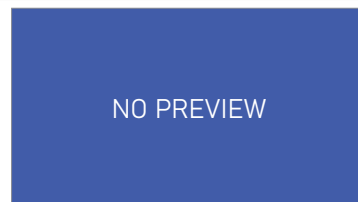

3DL72015 **Spitfire Mk.IXc SPACE**  
1/72 Eduard  
(2 parts)

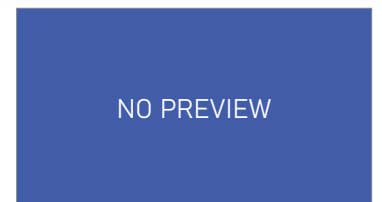

3DL72016 **B-25J SPACE**  
1/72 Hasegawa  
(2 parts)

## PHOTO-ETCHED SETS

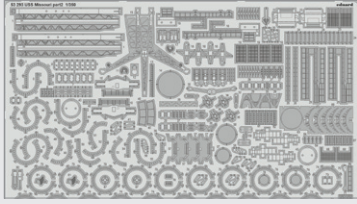

53293 USS Missouri BB-63 part 2  
1/350 Hobby Boss  
(1 part)

DETAIL

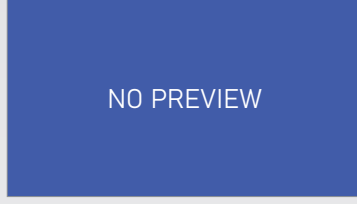

32482 CH-54A exterior  
1/35 ICM  
(1 part)

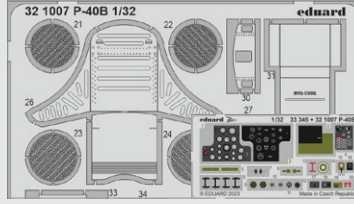

321007 P-40B  
1/32 Great Wall Hobby  
(2 parts)

DETAIL



321008 CH-54A  
1/35 ICM  
(2 parts)

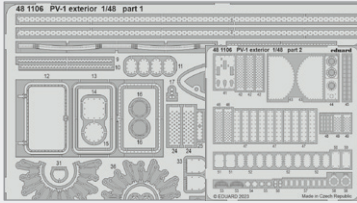

481106 PV-1 exterior  
1/48 Academy  
(2 parts)

DETAIL

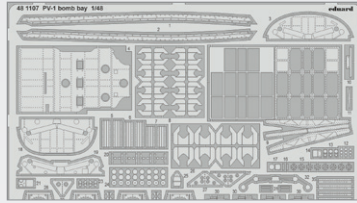

481107 PV-1 bomb bay  
1/48 Academy  
(1 part)

DETAIL

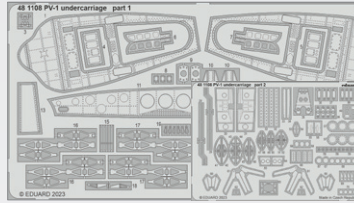

481108 PV-1 undercarriage  
1/48 Academy  
(2 parts)

DETAIL

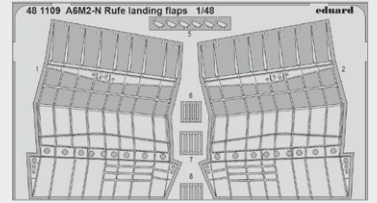

481109 A6M2-N Rufe landing flaps  
1/48 Eduard  
(1 part)

DETAIL

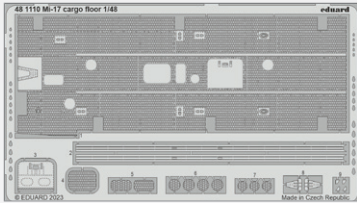

481110 Mi-17 cargo floor  
1/48 AMK  
(1 part)

DETAIL

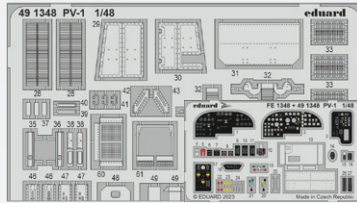

491348 PV-1  
1/48 Academy  
(2 parts)

DETAIL

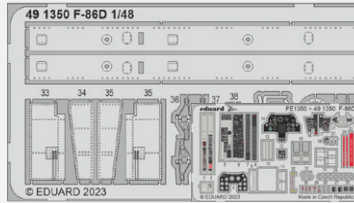

491350 F-86D  
1/48 Revell  
(2 parts)

DETAIL

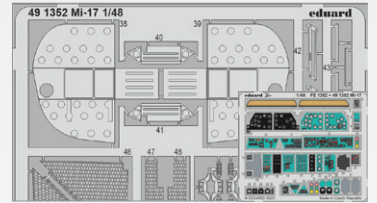

491352 Mi-17  
1/48 AMK  
(2 parts)

DETAIL

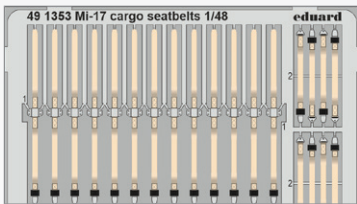

491353 Mi-17 cargo seatbelts  
1/48 AMK  
(1 part)

DETAIL

## PHOTO-ETCHED SETS

## ZOOM



33345 P-40B  
1/32 Great Wall Hobby  
(1 part)

DETAIL

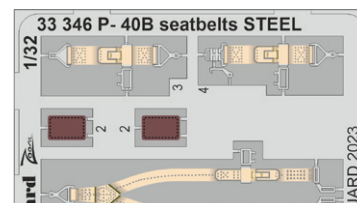

33346 P-40B seatbelts STEEL  
1/32 Great Wall Hobby  
(1 part)

DETAIL

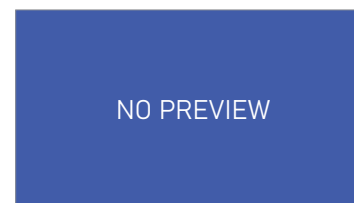

33347 CH-54A  
1/35 ICM  
(1 part)

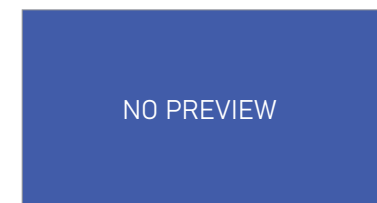

33348 CH-54A seatbelts STEEL  
1/35 ICM  
(1 part)

### PHOTO-ETCHED SETS

### ZOOM

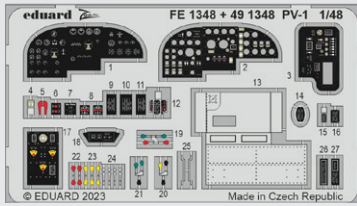

FE1348 PV-1  
1/48 Academy  
(1 part)

DETAIL

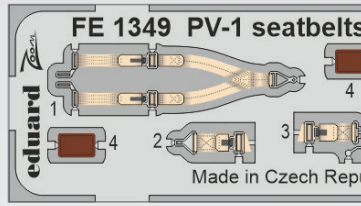

FE1349 PV-1 seatbelts STEEL  
1/48 Academy  
(1 part)

DETAIL

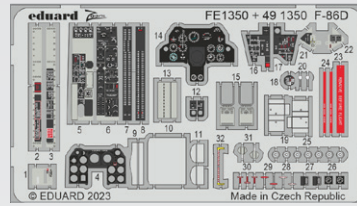

FE1350 F-86D  
1/48 Revell  
(1 part)

DETAIL

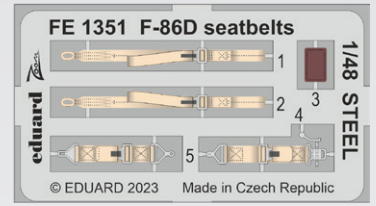

FE1351 F-86D seatbelts STEEL  
1/48 Revell  
(1 part)

DETAIL

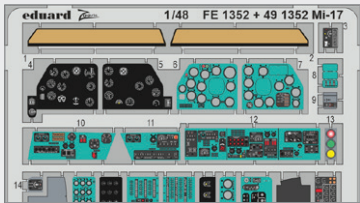

FE1352 Mi-17  
1/48 AMK  
(1 part)

DETAIL

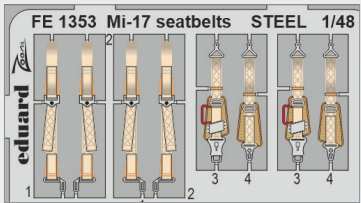

FE1353 Mi-17 seatbelts STEEL  
1/48 AMK  
(1 part)

DETAIL

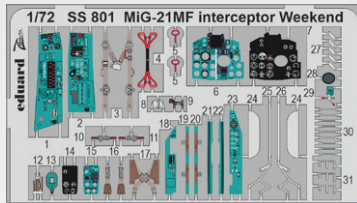

SS801 MiG-21MF interceptor  
WEEKEND 1/72 Eduard  
(1 part)

DETAIL

### BIG ED SETS



BIG49363 Anson Mk.I  
1/48 Airfix

DETAIL



BIG49364 F-16C  
Block 25 1/48 Kinetic

DETAIL



BIG49365 F-16C Block  
42 till 2005 1/48 Kinetic

DETAIL

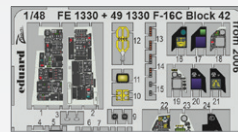

BIG49366 F-16C Block 42  
from 2006 1/48 Kinetic

DETAIL

### DECAL SET

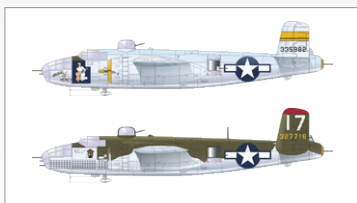

D48112 Angel of Mercy  
1/48 HKM  
(1 part)

DETAIL

### BRASSIN

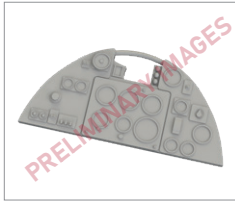

634033 Hurricane Mk.IIb LööK 1/32 Revell

DETAIL



634034 Spitfire Mk.IXc LööK 1/24 Airfix

DETAIL



644211 F-16A MLU LööK 1/48 Kinetic

DETAIL



644212 F-16C Block 42 till 2005 LööK 1/48 Kinetic

DETAIL



644213 F-16C Block 42 from 2006 LööK 1/48 Kinetic

DETAIL



624003 Spitfire Mk.IX exhaust fishtail PRINT 1/24 Airfix

DETAIL



632191 Luftwaffe rudder pedals PRINT 1/32 Revell

DETAIL

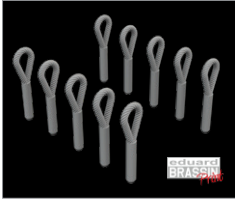

635027 WWII German towing cable eyes PRINT 1/35

DETAIL

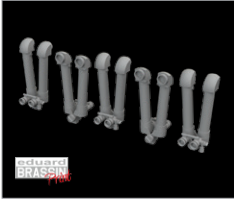

635028 WWII German trench binoculars PRINT 1/35

DETAIL

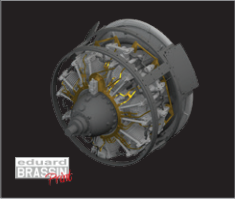

648827 F4F-3A engine PRINT 1/48 Eduard

DETAIL

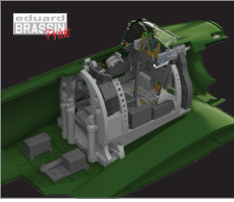

648850 A6M2-N Rufe cockpit PRINT 1/48 Eduard

DETAIL

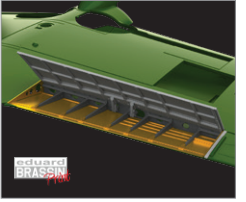

648851 A6M2-N Rufe landing flaps PRINT 1/48 Eduard

DETAIL

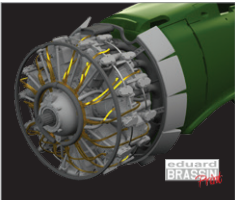

648852 A6M2-N Rufe engine complete PRINT 1/48 Eduard

DETAIL

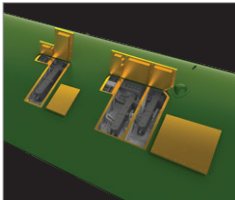

648853 F4F-4 gun bays PRINT 1/48 Eduard

DETAIL

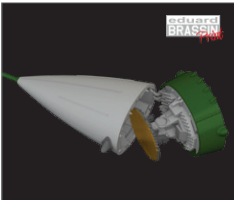

648856 F-16 radar late PRINT 1/48 Kinetic

DETAIL

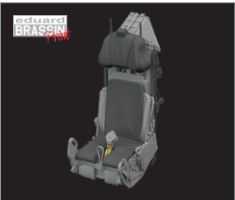

648827 F-35A ejection seat PRINT 1/48 Tamiya

DETAIL

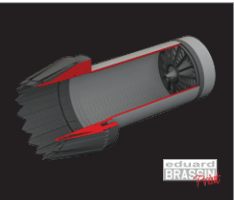

648860 F-35A exhaust nozzle PRINT 1/48 Tamiya

DETAIL

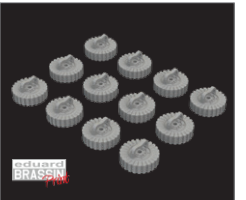

648861 Vickers 97-cartridges ammo magazines PRINT 1/48

DETAIL

### LööKplus

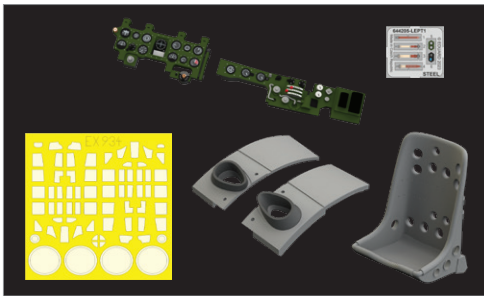

644208 A6M2-N Rufe LööKplus 1/48 Eduard

DETAIL

### LööKplus

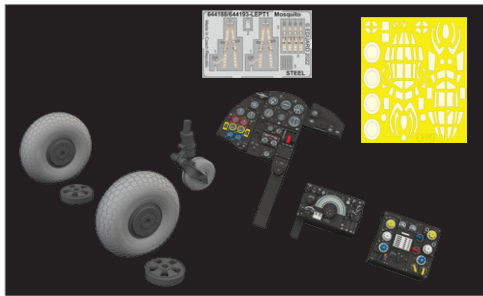

644209 Mosquito B Mk.IV LööKplus 1/48 Tamiya

DETAIL

### LööKplus

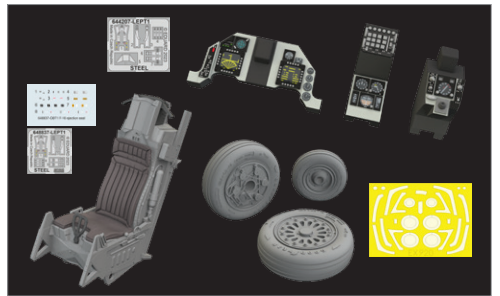

644210 F-16C Block 25 LööKplus 1/48 Kinetic

DETAIL

### BIGSIN

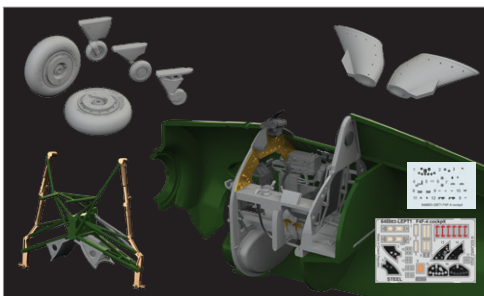

SIN648103 F4F-4 ESSENTIAL 1/48 Eduard

DETAIL

### BIGSIN

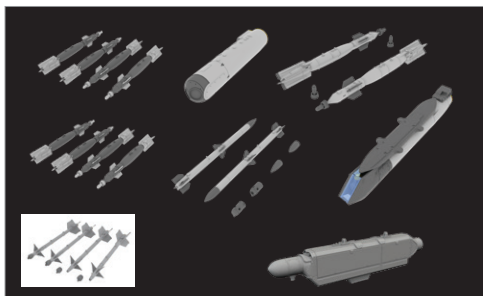

SIN648104 F-16 armament w/ laser guided bombs 1/48 Kinetic

DETAIL

ProfiPACK edition kit of US naval fighter aircraft F6F-5 Hellcat in 1/48 scale. This version of the legendary naval fighter was without a window in the fuselage behind the cockpit.

### BASIC INFO:

NAME: **F6F-5 Hellcat late**

CAT. NO.: 8229

SCALE: 1/48

EDITION: ProfiPACK

### CONTENTS:

SPRUES: Eduard

PE-SETS: Yes, pre-painted

PAINTING MASK: Yes

MARKING OPTIONS: 6

BRASSIN: Yes, wheels

### RELATED PRODUCTS:

48585 F6F undercarriage (PE-Set)

48588 F6F gun bay (PE-Set)

491347 F6F-5 (PE-Set)

FE1065 F6F-5 seatbelts STEEL (PE-Set)

644012 F6F-5 LööK (Brassin)

648061 HVAR rockets (Brassin)

648086 US 250lb bombs (2 pcs) (Brassin)

648102 F6F wheels (Brassin)

648683 F6F exhaust stacks (Brassin)

648747 F6F undercarriage legs BRONZE (Brassin)

648798 F6F wheel bays PRINT (Brassin)

3DL48069 F6F-5 SPACE (3D Decal Set)

EX866 F6F-5 TFace (Mask)

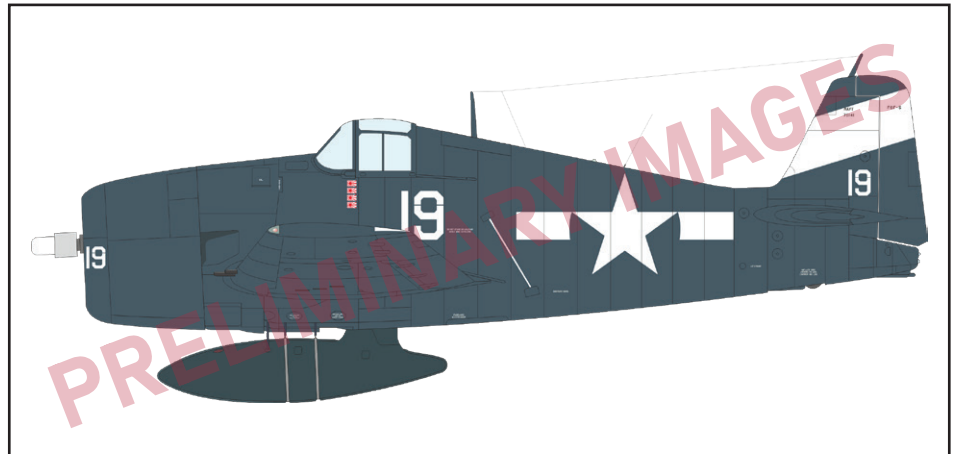

### KIT PARTS

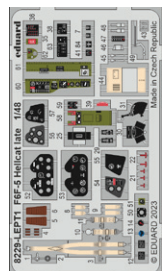
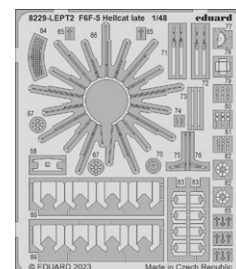
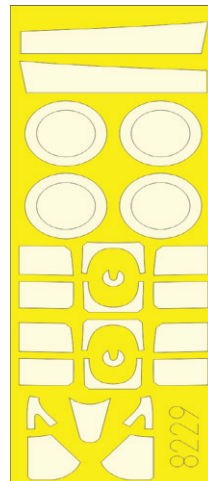
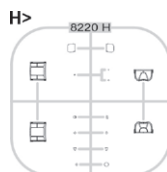
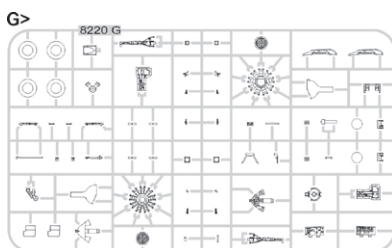
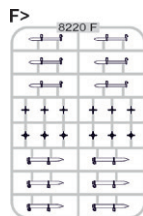
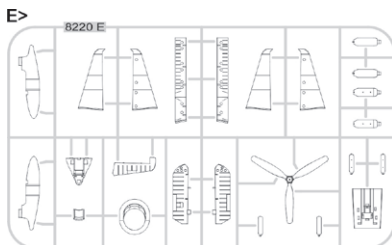
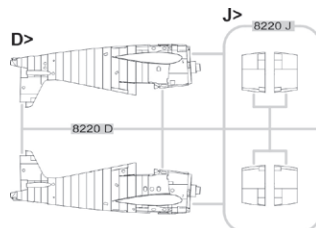
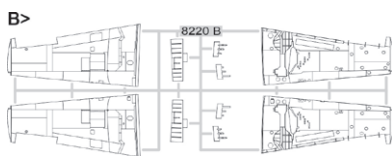

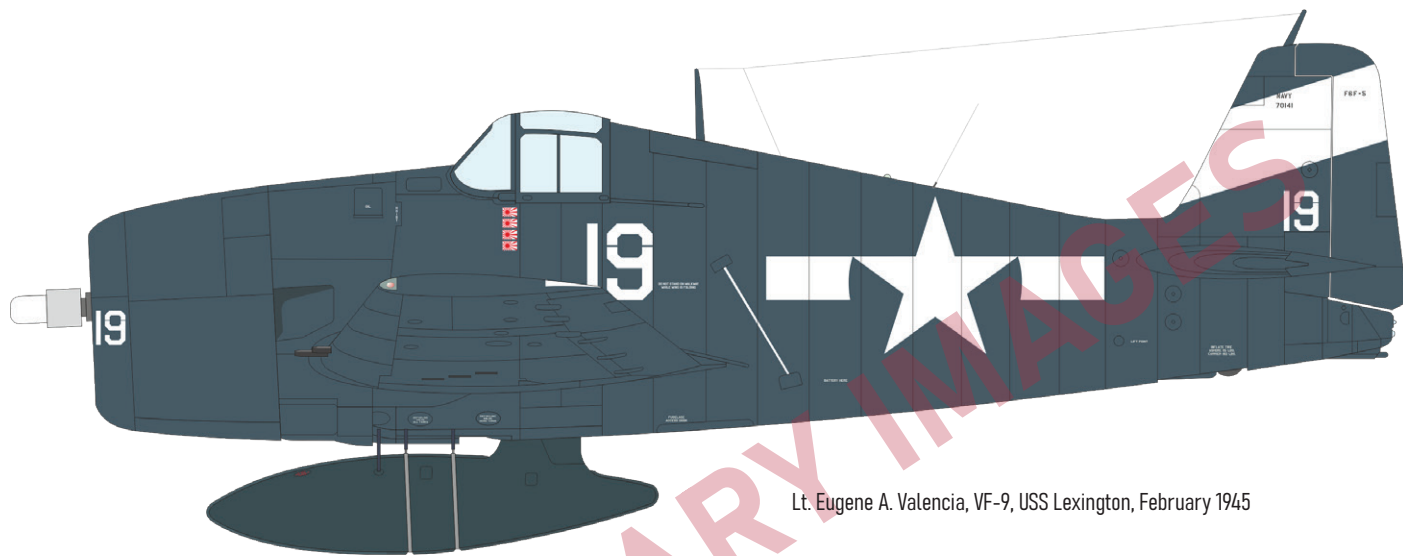

Lt. Eugene A. Valencia, VF-9, USS Lexington, February 1945

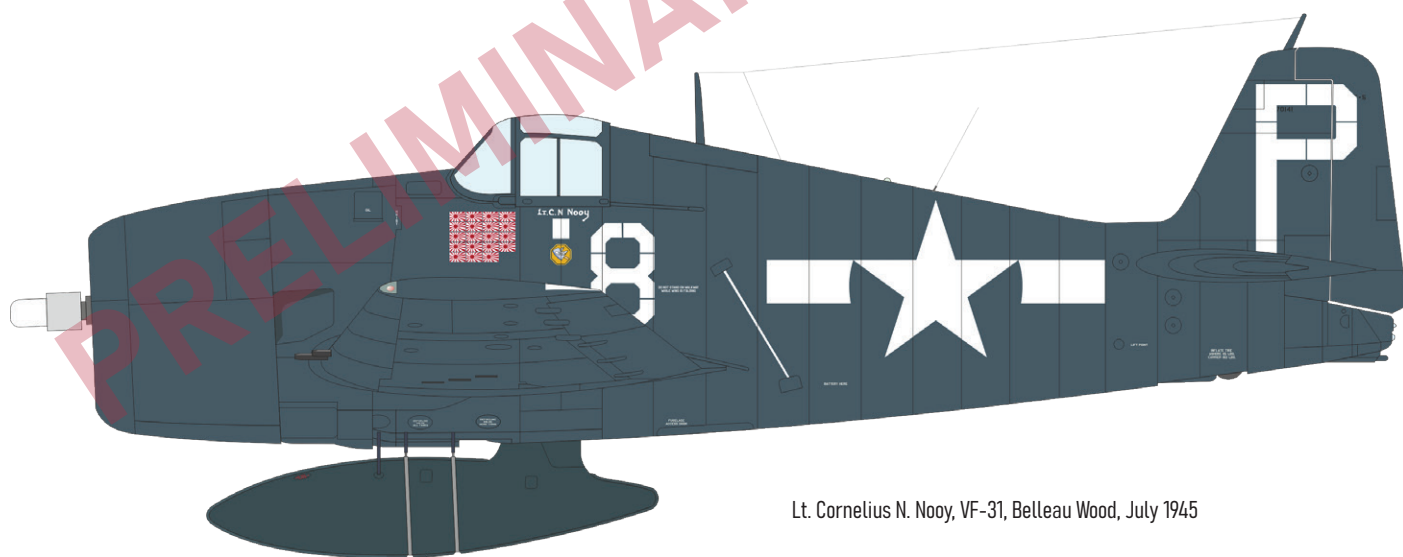

Lt. Cornelius N. Nooy, VF-31, Belleau Wood, July 1945

## + four more marking options

Lt James Lano Pearce, VF-17, USS Hornet, March 18-21, 1945

Lt Louis A Menard, VBF-12, USS Randolph, February 17, 1945

Ens William A. Sinnott, VF-24, USS Santee, July 7, 1945

Flotille 1F, PA Arromanche, French Indochina, 1951

Limited edition kit of British WWII fighter aircraft Spitfire Mk.Vb and Vc in 1/48 scale. From the kit you can build Spitfires fighting in the defence of the island Malta.

## DUAL COMBO

### BASIC INFO:

NAME: **SPITFIRE STORY: MALTA**  
**DUAL COMBO**

CAT. NO.: 11172

SCALE: 1/48

EDITION: LIMITED

### CONTENTS:

SPRUES: Eduard

PE-SETS: Yes, pre-painted

PAINTING MASK: Yes

MARKING OPTIONS: 15

BRASSIN: No

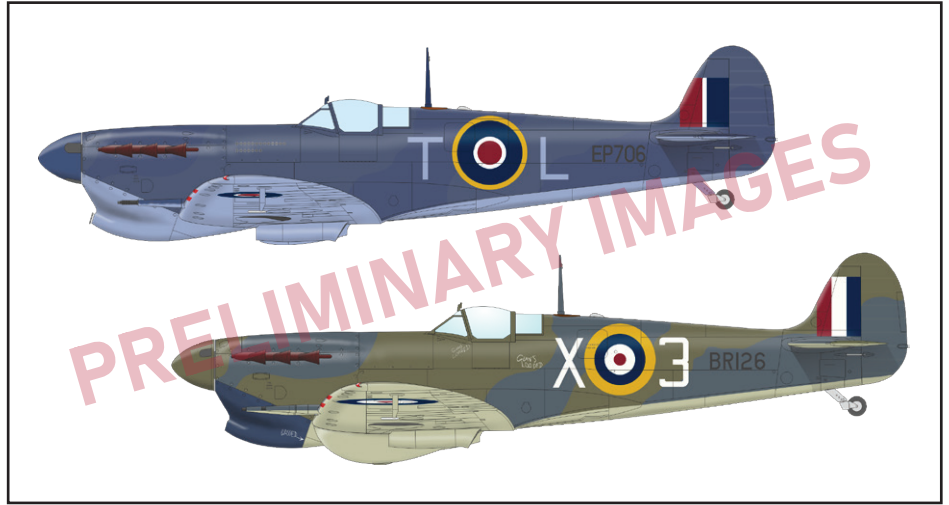

### RELATED PRODUCTS:

481065 Spitfire Mk.V landing flaps (PE-Set)

FE1207 Spitfire Mk.V seatbelts STEEL (PE-Set)

644113 Spitfire Mk.V LööK (Brassin)

648640 Spitfire Mk.V engine (Brassin)

648663 Spitfire Mk.V cockpit (Brassin)

648664 Spitfire Mk.V wheels (Brassin)

648665 Spitfire Mk.Vb gun bays (Brassin)

648666 Spitfire Mk.Vc gun bays (Brassin)

648667 Spitfire Mk.V three-stacks exhausts rounded (Brassin)

648668 Spitfire Mk.V three-stacks exhausts fishtail (Brassin)

648669 Spitfire Mk.V six-stacks exhausts fishtail (Brassin)

648670 Spitfire Mk.Va/b undercarriage legs BRONZE (Brassin)

648671 Spitfire Mk.Vc undercarriage legs BRONZE (Brassin)

648738 Spitfire Mk.V landing flaps PRINT (Brassin)

3DL48031 Spitfire Mk.V SPACE (3D Decal Set)

D48101 Spitfire Mk.V national insignia (Decal Set)

EX914 Spitfire Mk.V TFace (Mask)

### KIT PARTS

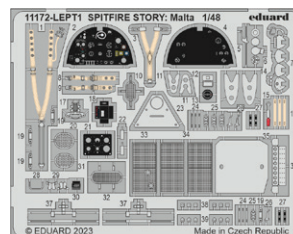
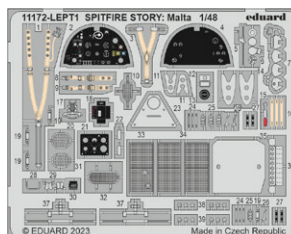
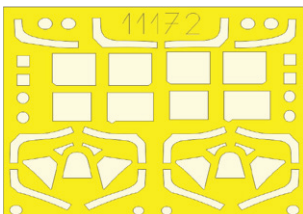
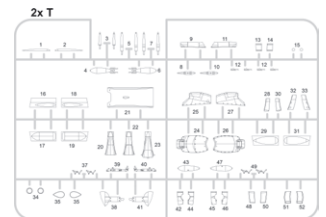
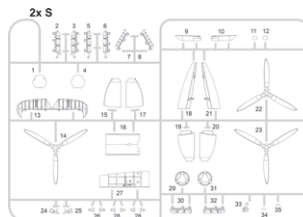
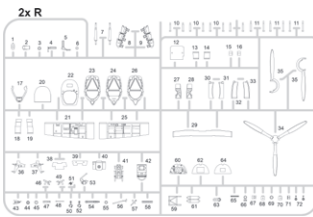
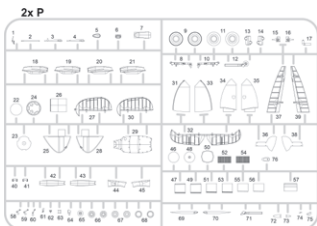
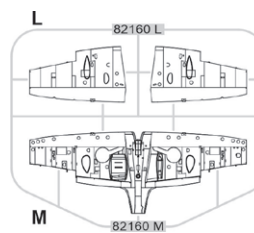
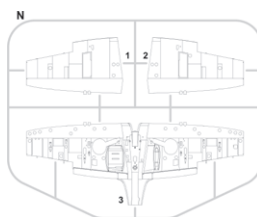
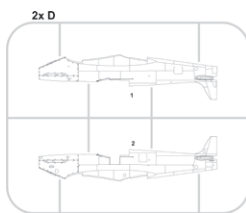
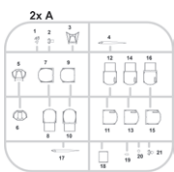



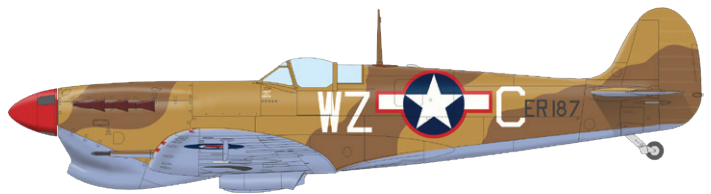
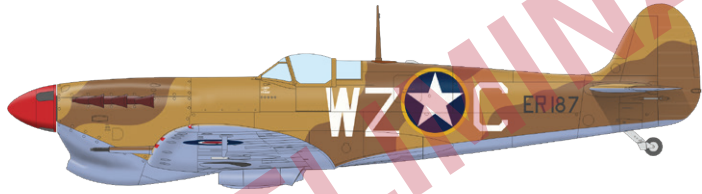
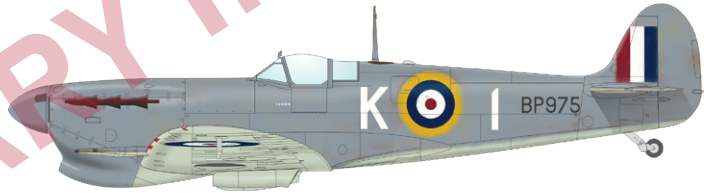
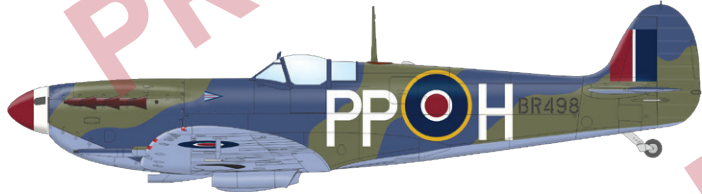
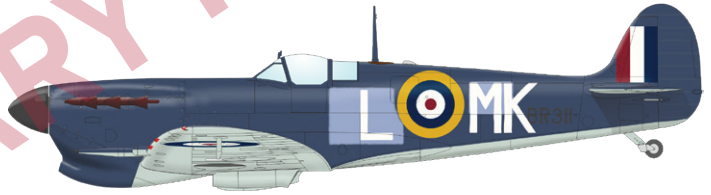
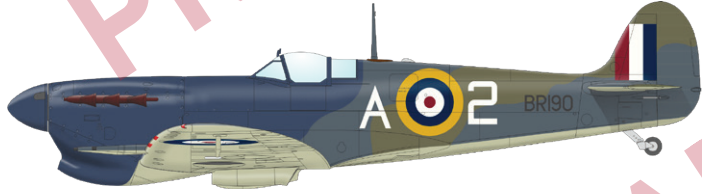
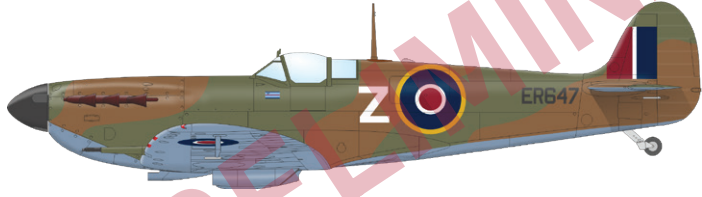
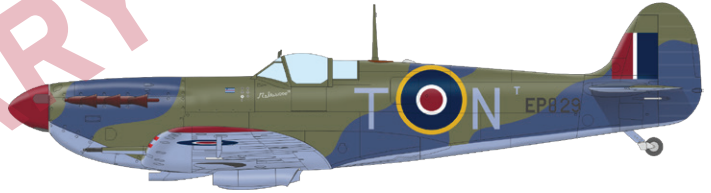
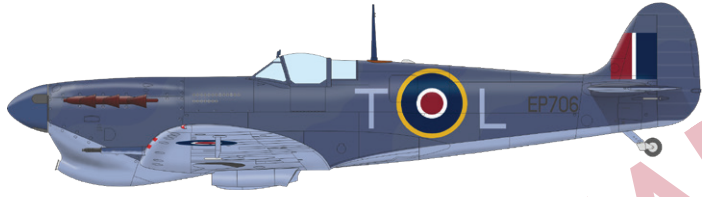

PRELIMINARY IMAGES

Weekend edition kit of Soviet Cold war jet fighter aircraft MiG-21MF interceptor in 1/72 scale.

**BASIC INFO:**

NAME: **MiG-21MF Interceptor**

CAT. NO.: 7469

SCALE: 1/72

EDITION: Weekend edition

**CONTENTS:**

SPRUES: Eduard

PE-SETS: No

PAINTING MASK: No

MARKING OPTIONS: 4

BRASSIN: No

**RELATED PRODUCTS:**

72689 MiG-21MF (PE-Set)

SS801 MiG-21MF interceptor WEEKEND (PE-Set)

672181 MiG-21MF exhaust nozzle (Brassin)

672182 MiG-21MF wheels (Brassin)

672185 R-3S missiles for MiG-21 (Brassin)

672186 R-3S missiles w/ pylons for MiG-21 (Brassin)

672189 UB-16 rocket launchers for MiG-21 (Brassin)

672190 UB-16 rocket launchers w/ pylons for MiG-21 (Brassin)

672191 RS-2US missiles for MiG-21 (Brassin)

672192 RS-2US missiles w/ pylons for MiG-21 (Brassin)

672193 MiG-21MF airbrakes (Brassin)

672195 SPS-141 ECM pod for MiG-21 (Brassin)

672197 MiG-21MF ejection seat (Brassin)

SIN67217 MiG-21MF armament (Brassin)

3DL72002 MiG-21MF SPACE (3D Decal Set)

D72015 MiG-21MF stencils (Decal Set)

CX511 MiG-21MF (Mask)

CX512 MiG-21MF TFace (Mask)



**KIT PARTS**

**A>**

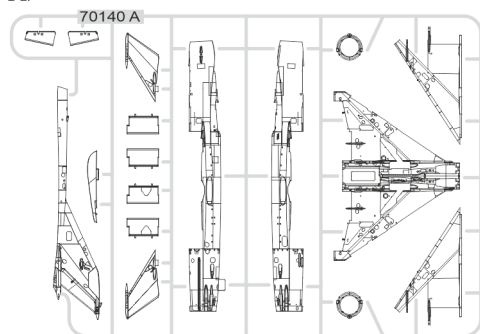

**C>**

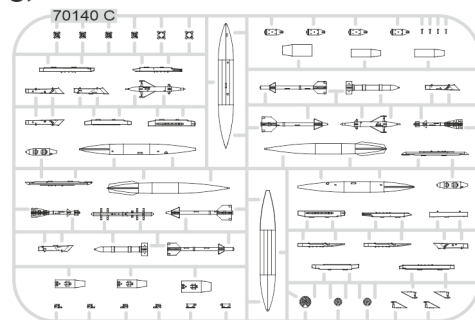

**D>**

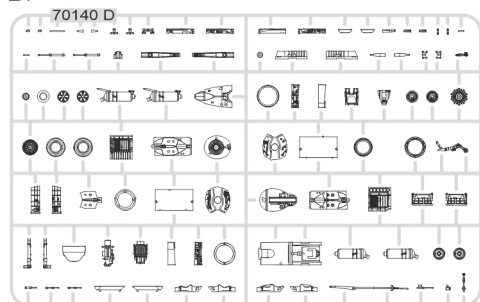

**E>**

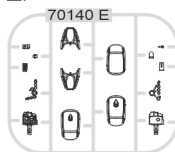

NO PREVIEW

Weekend edition kit of German WWII fighter aircraft Bf 109F-4 in 1/48 scale.

**BASIC INFO:**

NAME: **Bf 109F-4**

CAT. NO.: 84188

SCALE: 1/48

EDITION: Weekend edition

**CONTENTS:**

SPRUES: Eduard

PE-SETS: No

PAINTING MASK: No

MARKING OPTIONS: 4

BRASSIN: No

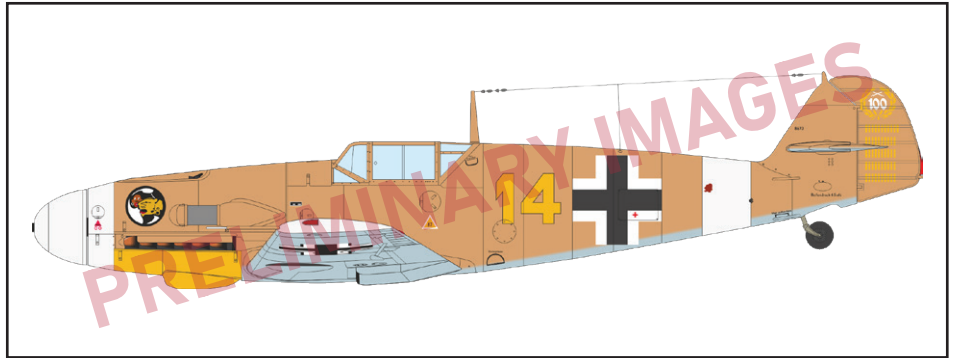

**RELATED PRODUCTS:**

FE844 Bf 109F-4 Weekend (PE-Set)

644010 Bf 109F LööK (Brassin)

648282 Bf 109F wheels (Brassin)

648288 Bf 109F propeller LATE (Brassin)

648289 Bf 109F propeller EARLY (Brassin)

648291 Bf 109F landing flaps (Brassin)

648300 Bf 109F engine & fuselage guns (Brassin)

648308 Bf 109F undercarriage legs BRONZE (Brassin)

3DL48028 Bf 109F-4 SPACE (3D Decal Set)

D48026 Bf 109F stencils (Decal Set)

EX535 Bf 109F-4 (Mask)

EX588 Bf 109F TFace (Mask)

**KIT PARTS**

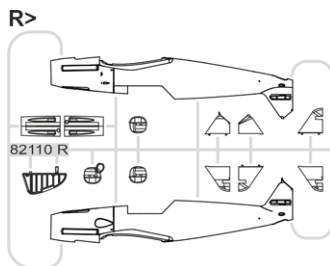
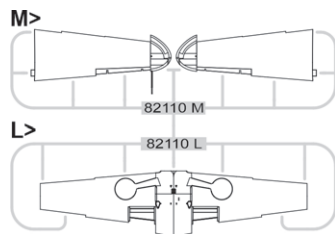
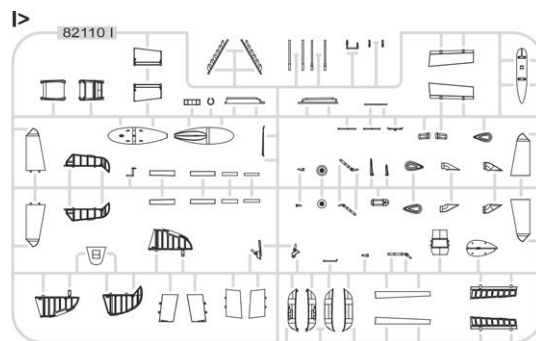
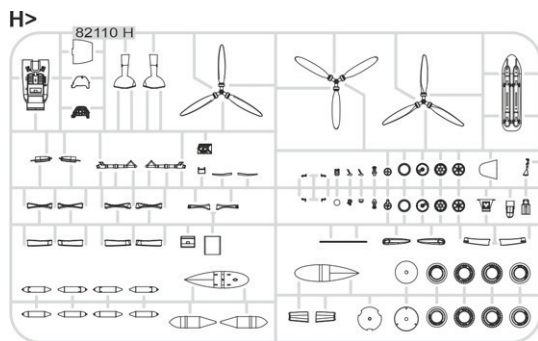

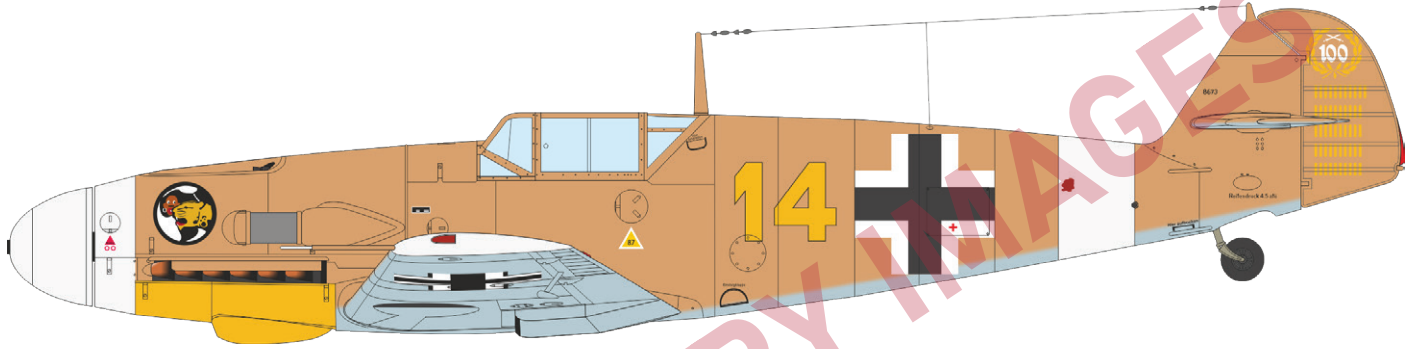

Bf 109F-4/Trop, WNr. 8673, Hptm. Hans-Joachim Marseille, CO of 3./JG 27, Quotaifiya, Egypt, September 1942

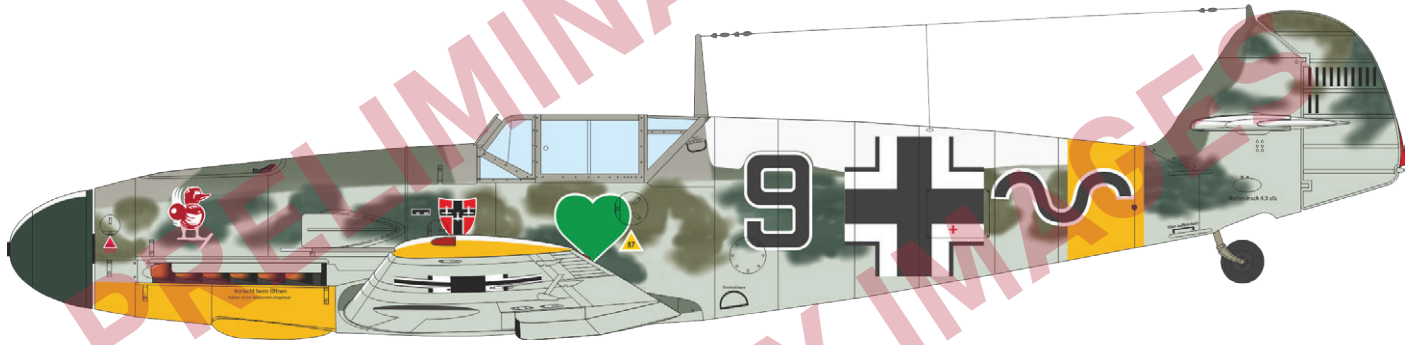

Bf 109F-4, Lt. Hans-Joachim Heyer, 8./JG 54, Siverskaja, Soviet Union, April 1942

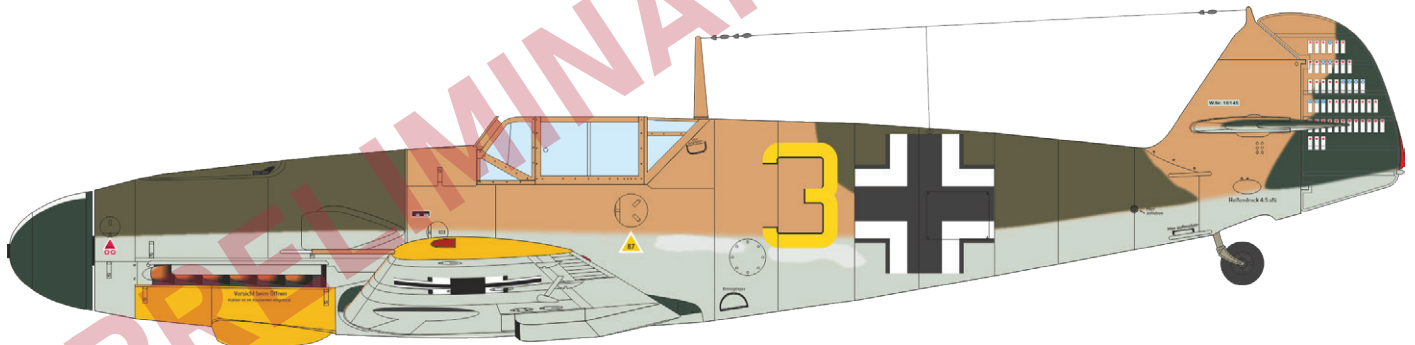

Bf 109F-4/Trop, WNr. 10145, Fw. Rudolf Müller, 6./JG 5, Petsamo, Finland, June 1942

### + one more marking option

Bf 109F-4/Z, WNr. 7420, Lt. Hermann Anton Graf, CO of 9./JG 52, Kharkov-Rogan, Soviet Union, May 1942

ProfiPACK edition kit of German WWII fighter aircraft Fw 190F-8 in 1/72 scale. Version F was used for attacks against ground targets.

## Re-release

### BASIC INFO:

NAME: **Fw 190F-8 Re-release**

CAT. NO.: 70119

SCALE: 1/72

EDITION: ProfiPACK

### CONTENTS:

SPRUES: Eduard

PE-SETS: Yes, pre-painted

PAINTING MASK: Yes

MARKING OPTIONS: 5

BRASSIN: No



### RELATED PRODUCTS:

672080 Fw 190A wheels late (Brassin)

672082 Fw 190A-8 engine (Brassin)

672085 Fw 190A exhaust stacks (Brassin)

672086 Fw 190A propeller (Brassin)

672088 Fw 190A-8 engine & fuselage guns (Brassin)

672113 SC 250 German WWII bombs (Brassin)

672115 SC 50 German WWII bombs (Brassin)

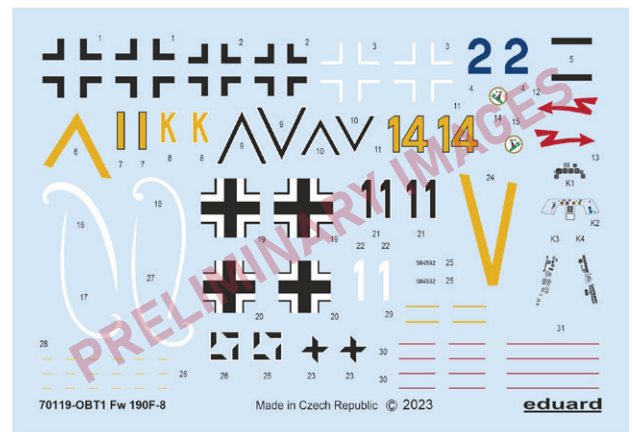

### KIT PARTS

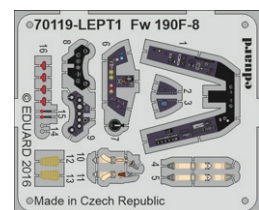
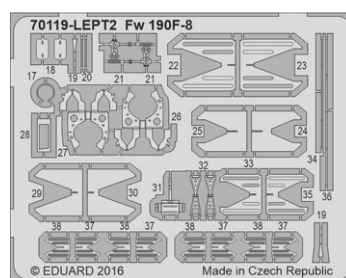
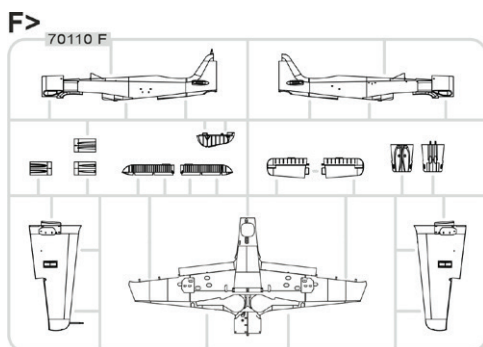
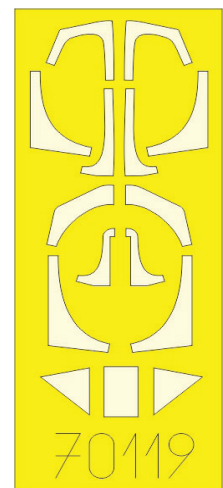
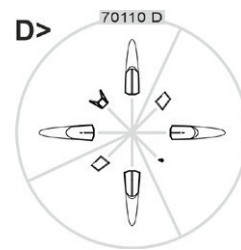
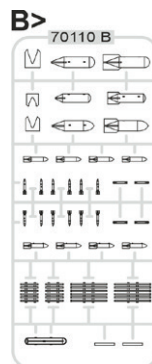
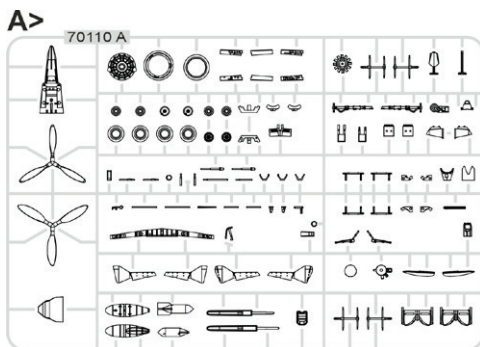

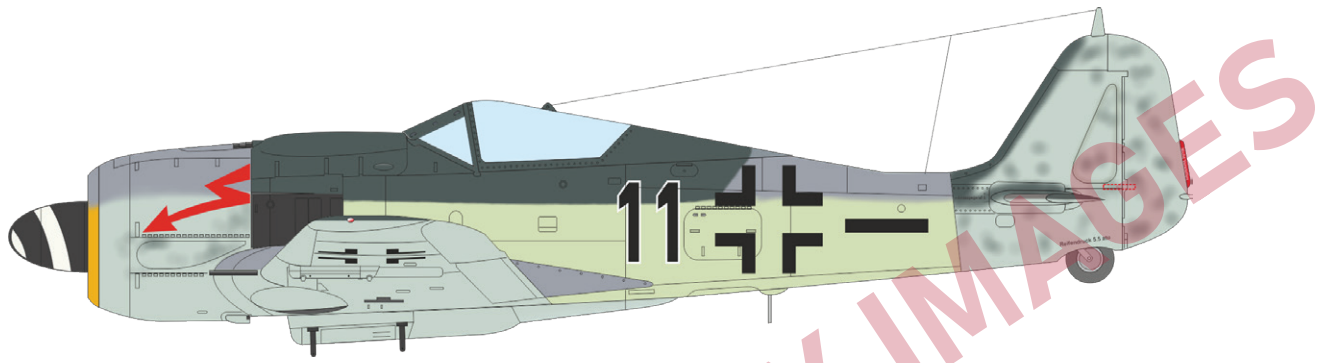

5./SG 77, Cottbus, Germany, early March 1945

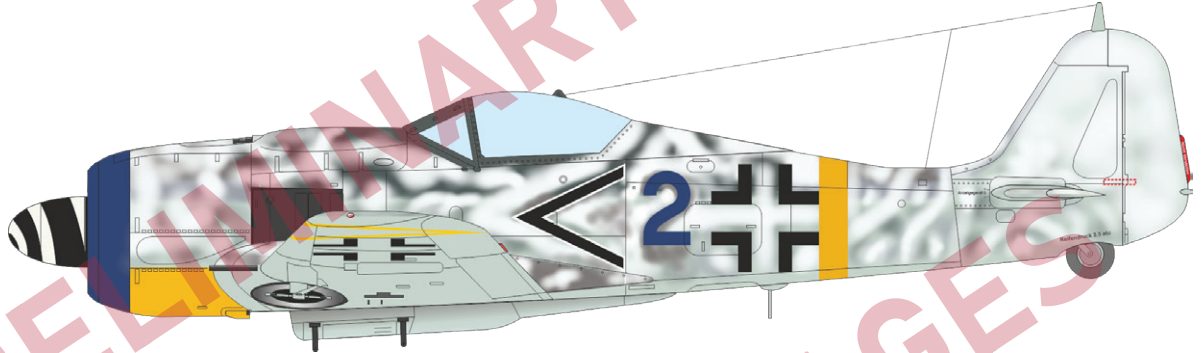

SG 2, Hungary, Winter 1944/1945

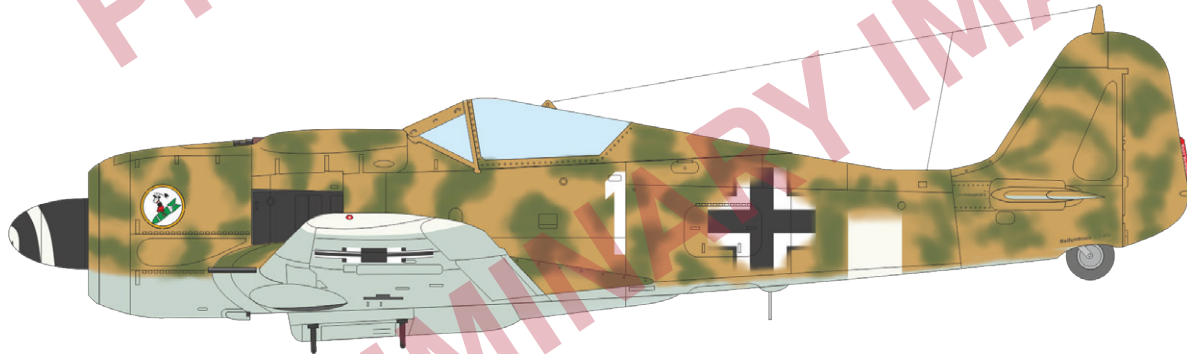

1./SG 4, Piacenza, Italy 1944

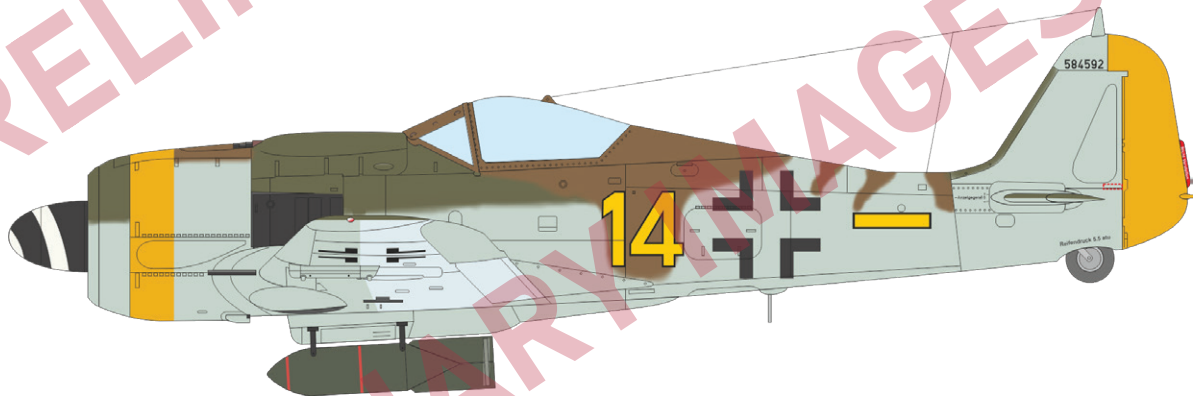

Wnr. 584592, SG 2 or SG 10, Neubiberg, Germany, May 1945

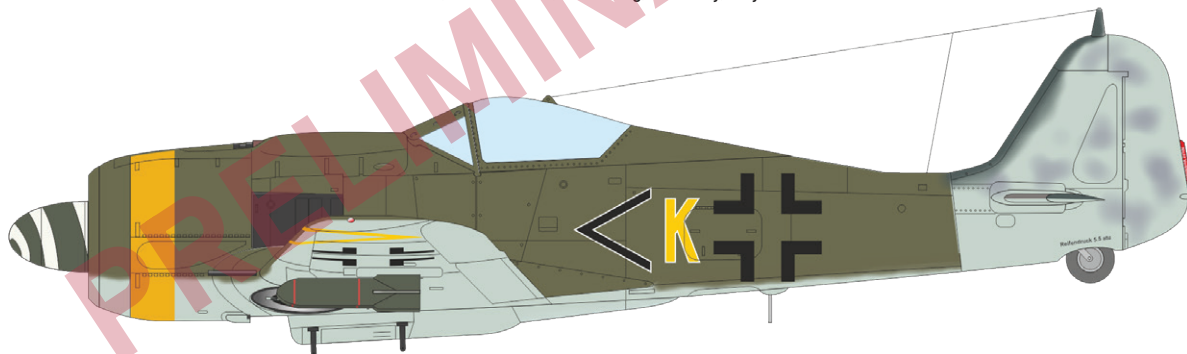

SG 10, České Budějovice, Protectorate of Bohemia and Moravia, May 1945

ProfiPACK edition kit of legendary German WWI triplane Fokker Dr.I in 1/48 scale.

## Re-release

### BASIC INFO:

NAME: **Fokker Dr.I Re-release**

CAT. NO.: 8162

SCALE: 1/48

EDITION: ProfiPACK

### CONTENTS:

SPRUES: Eduard

PE-SETS: Yes, pre-painted

PAINTING MASK: Yes

MARKING OPTIONS: 6

BRASSIN: No

### RELATED PRODUCTS:

48505 WWI Wheel Wire Discs (PE-Set)

49107 Seatbelts RFC WWI STEEL (PE-Set)

49194 WWI Instruments (PE-Set)

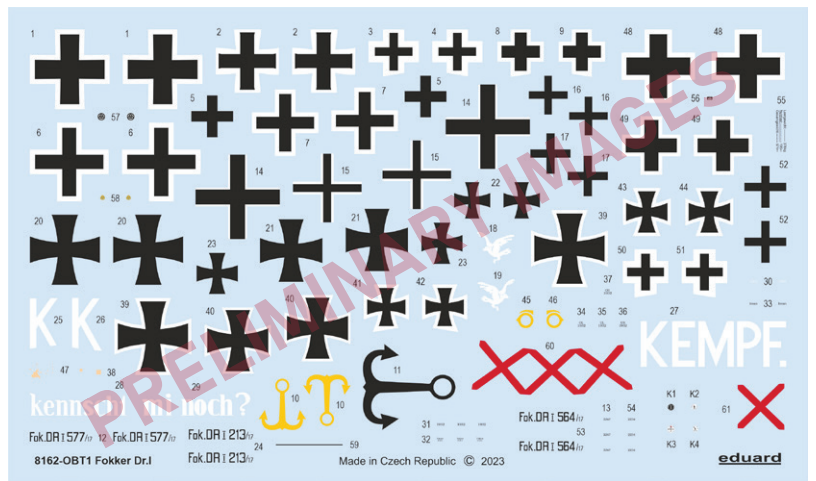
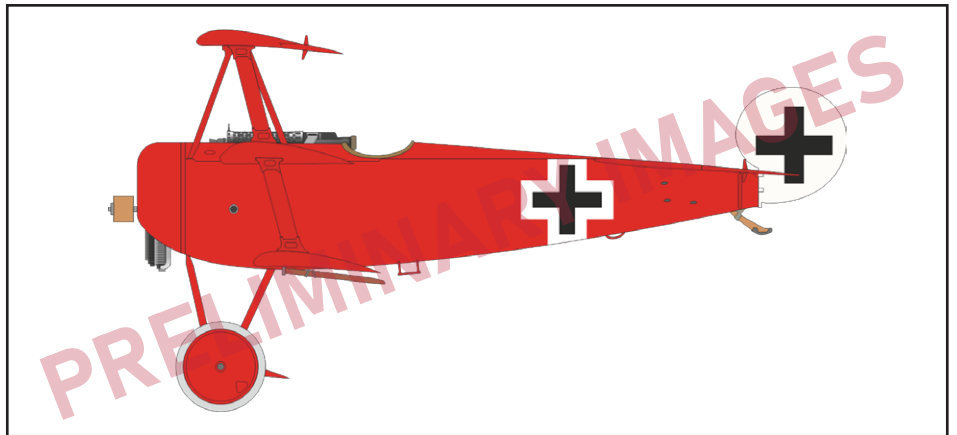

### KIT PARTS

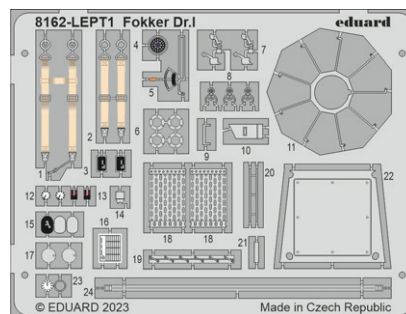
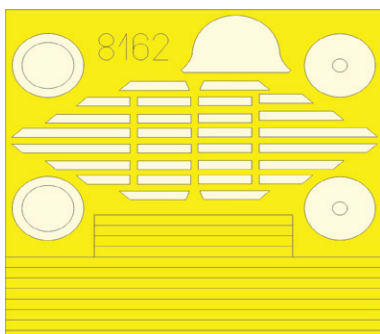
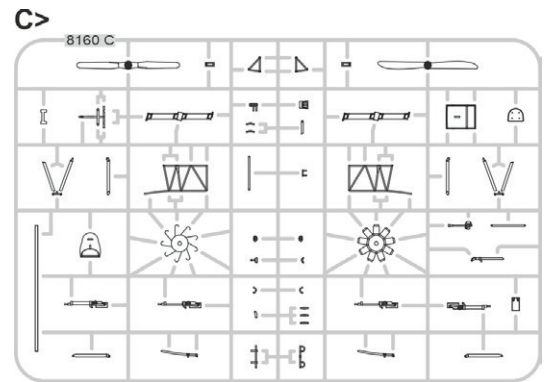
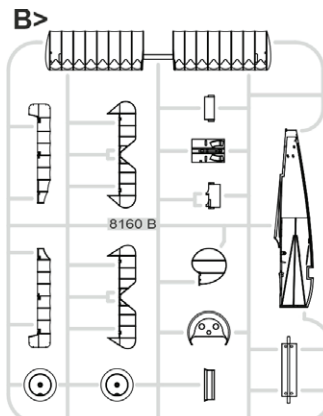
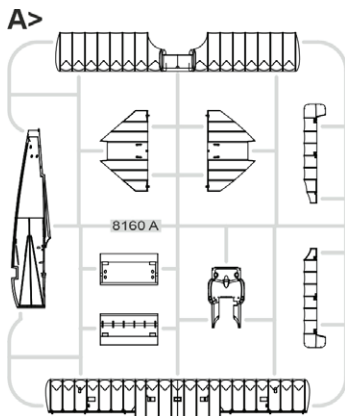



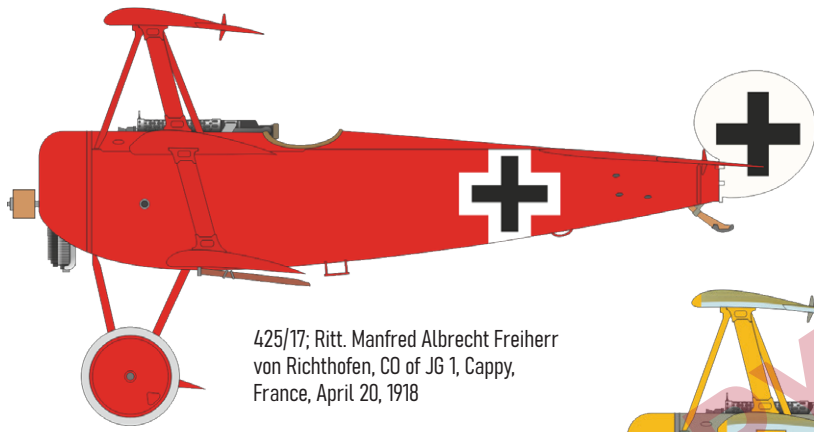

425/17; Ritt. Manfred Albrecht Freiherr von Richthofen, CO of JG 1, Cappy, France, April 20, 1918

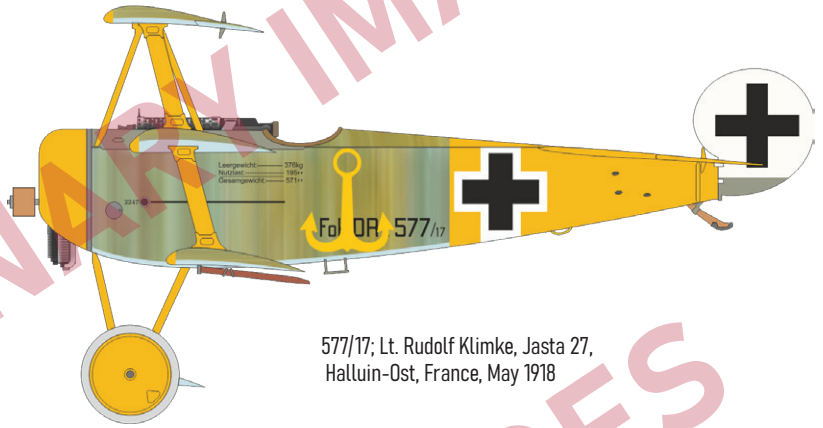

577/17; Lt. Rudolf Klimke, Jasta 27, Halluin-Ost, France, May 1918

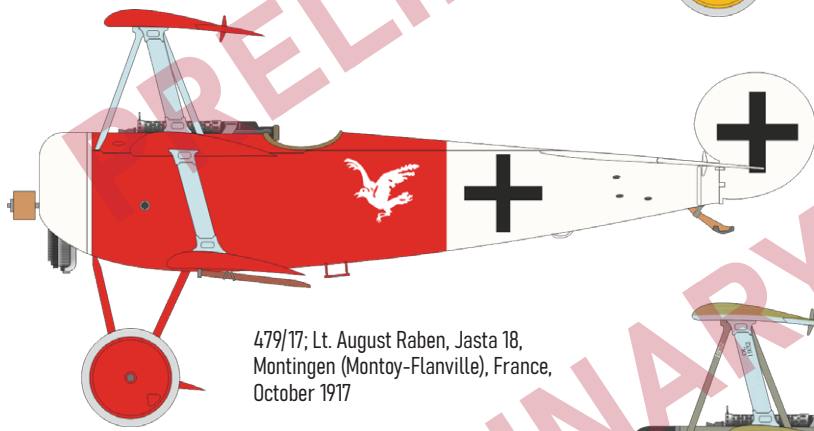

479/17; Lt. August Raben, Jasta 18, Montingen (Montoy-Flanville), France, October 1917



213/17; Lt. Friedrich Paul Kempf, Jasta 2, Bavichove, Belgium, February 1918

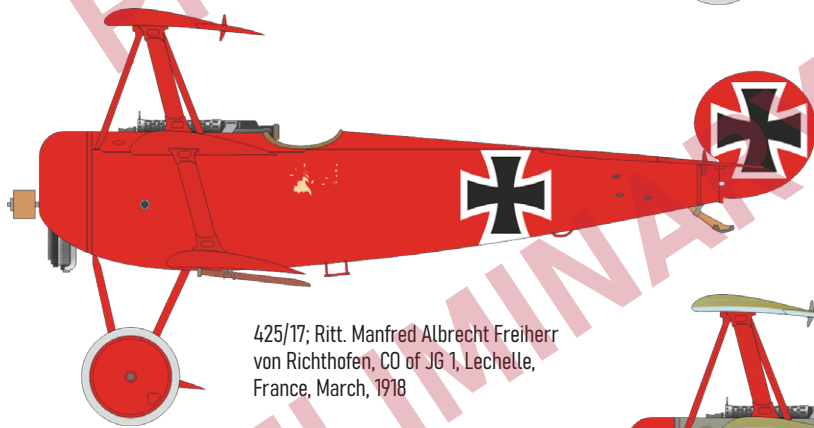

425/17; Ritt. Manfred Albrecht Freiherr von Richthofen, CO of JG 1, Lechelle, France, March, 1918

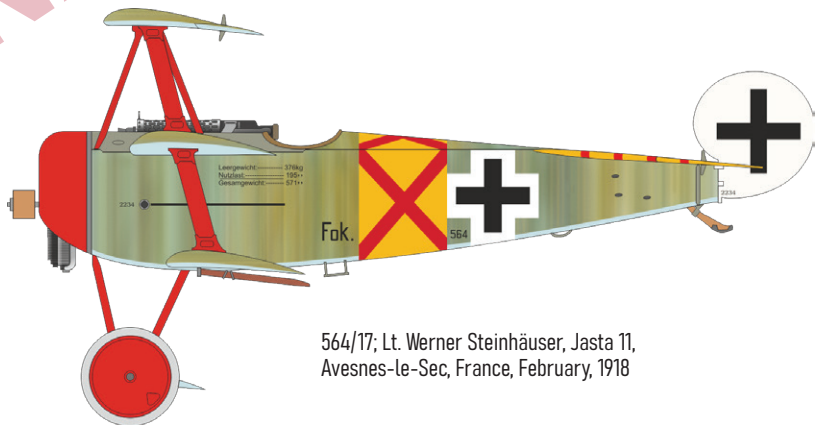

564/17; Lt. Werner Steinhäuser, Jasta 11, Avesnes-le-Sec, France, February, 1918

53293 USS Missouri BB-63 part 2  
1/350 Hobby Boss

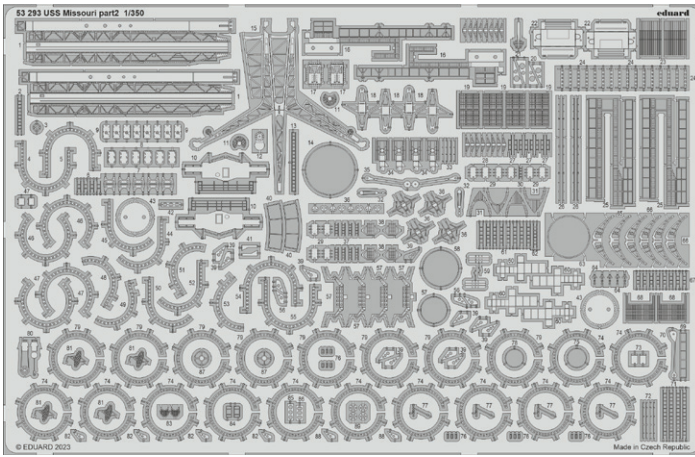

321007 P-40B  
1/32 Great Wall Hobby

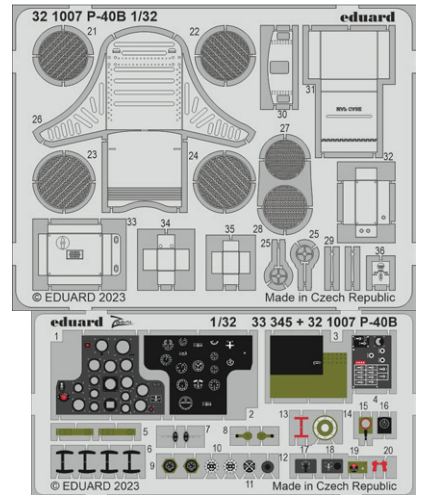

481106 PV-1 exterior  
1/48 Academy

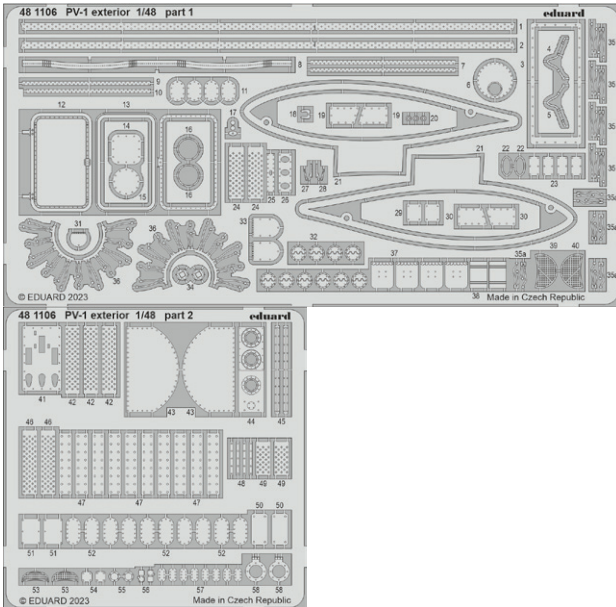

481107 PV-1 bomb bay  
1/48 Academy

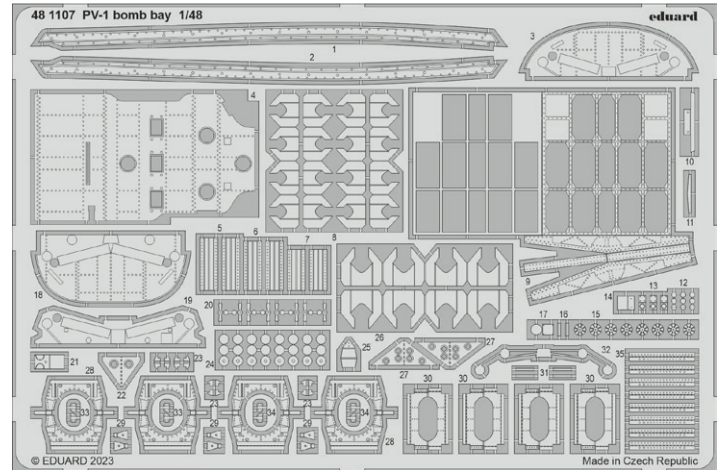

481108 PV-1 undercarriage  
1/48 Academy

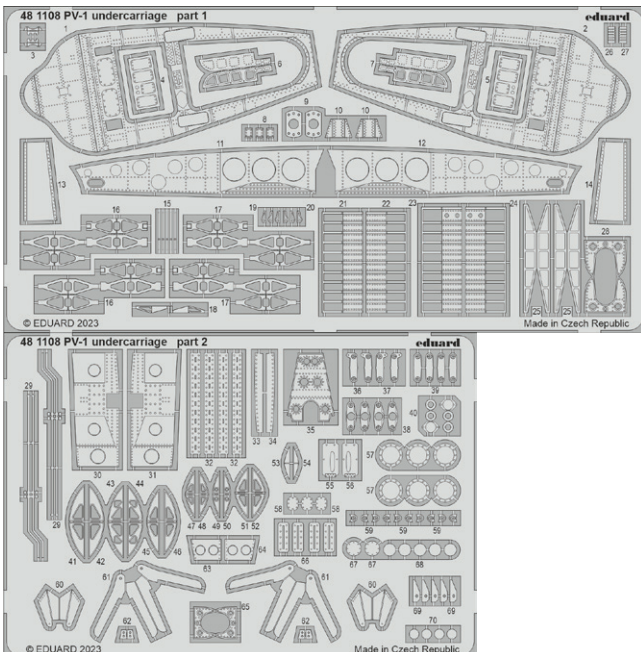

481109 A6M2-N Rufe landing flaps  
1/48 Eduard

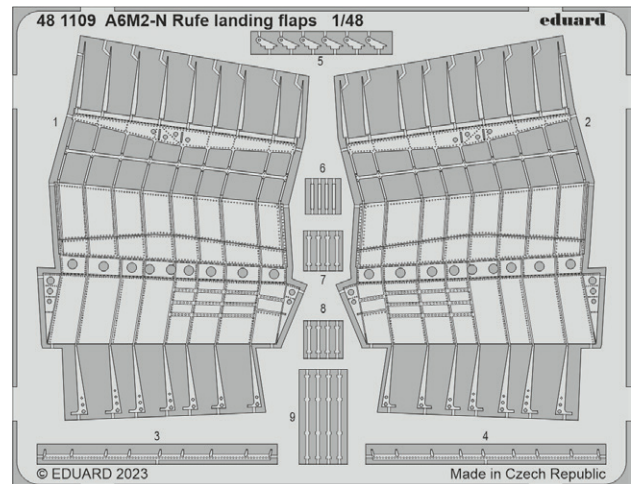

481110 Mi-17 cargo floor  
1/48 AMK

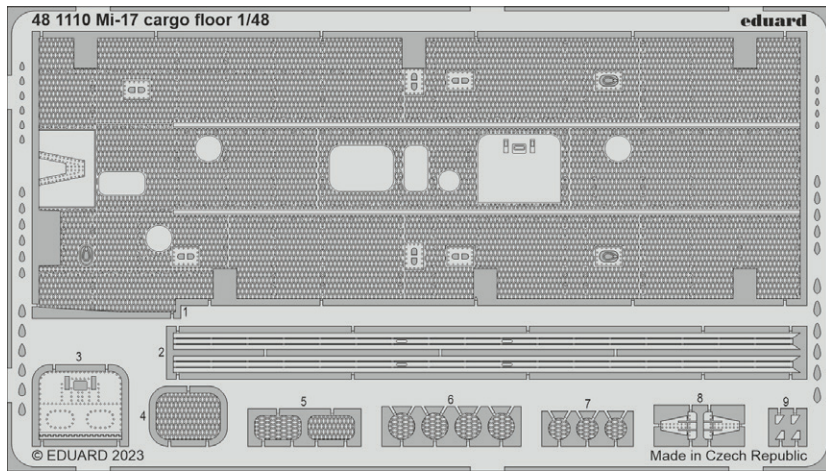

491348 PV-1  
1/48 Academy

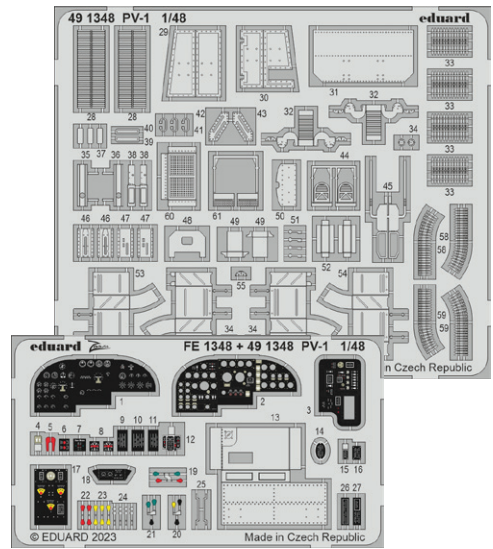

491350 F-86D  
1/48 Revell

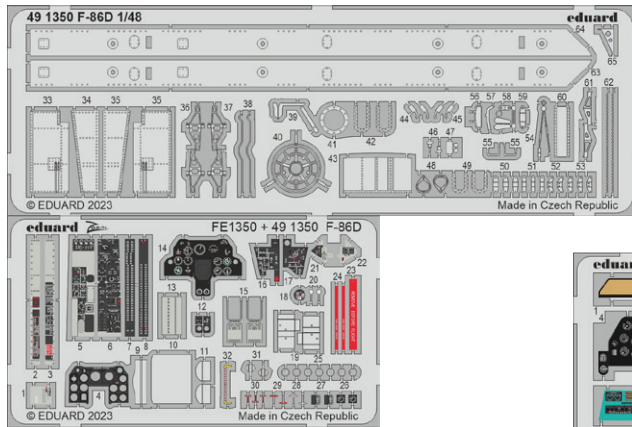

491352 Mi-17  
1/48 AMK

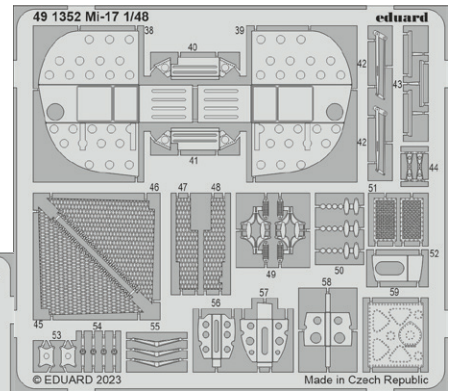

491353 Mi-17 cargo seatbelts  
1/48 AMK

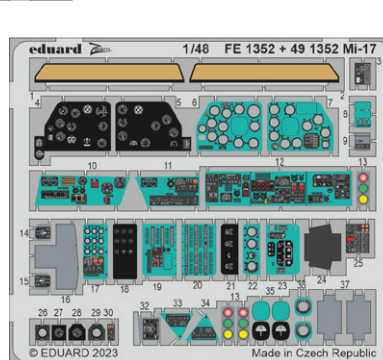
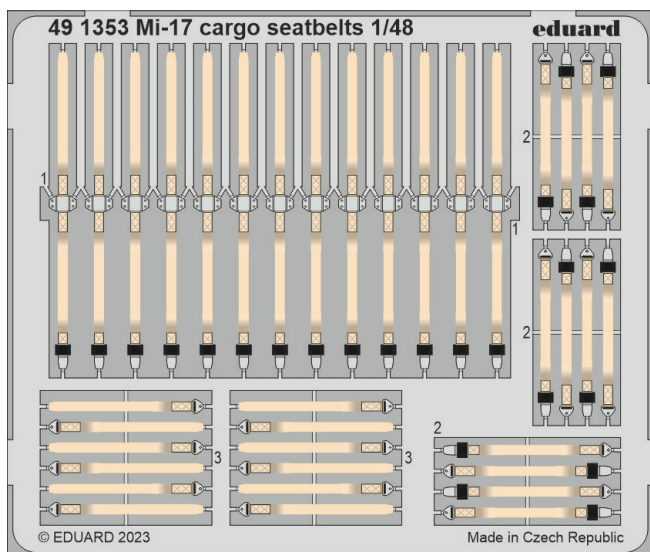

33345 P-40B  
1/32 Great Wall Hobby

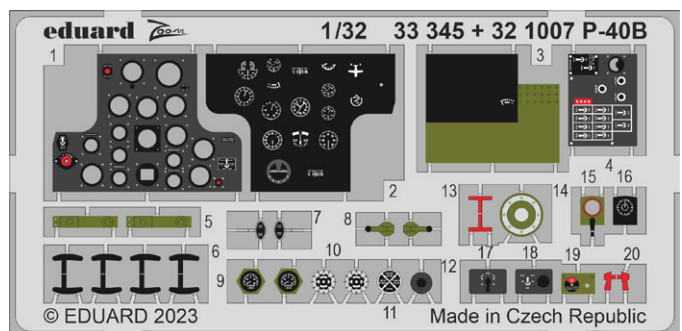

33346 P-40B seatbelts STEEL  
1/32 Great Wall Hobby

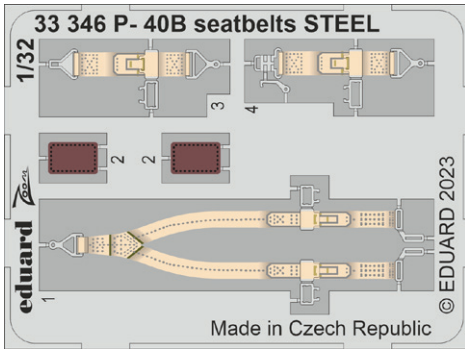

FE1348 PV-1  
1/48 Academy

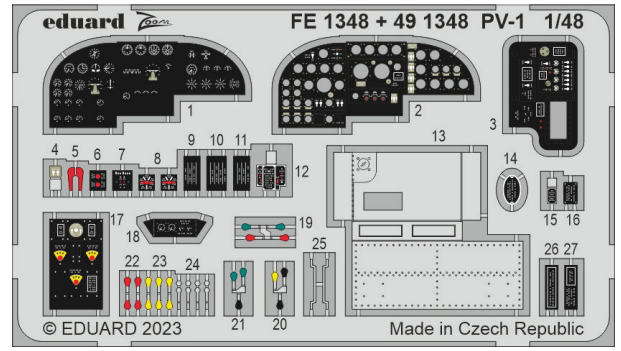

FE1349 PV-1 seatbelts STEEL  
1/48 Academy

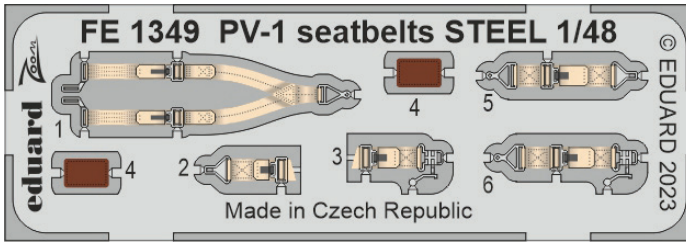

FE1350 F-86D  
1/48 Revell

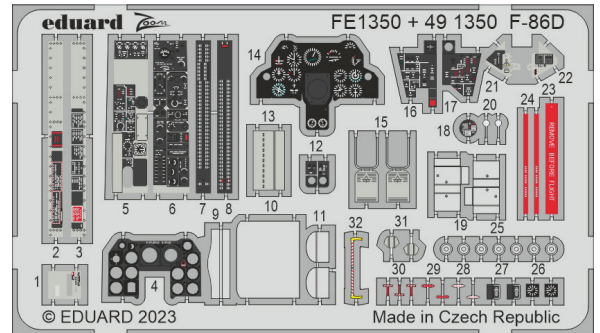

FE1351 F-86D seatbelts STEEL  
1/48 Revell

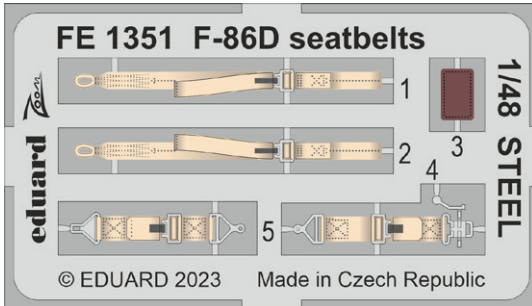

FE1352 Mi-17  
1/48 AMK

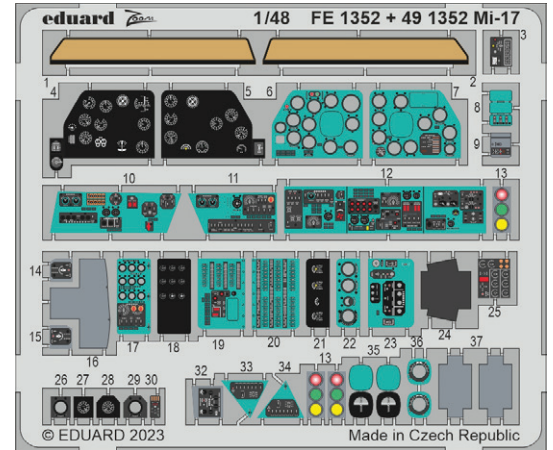

FE1353 Mi-17 seatbelts STEEL  
1/48 AMK

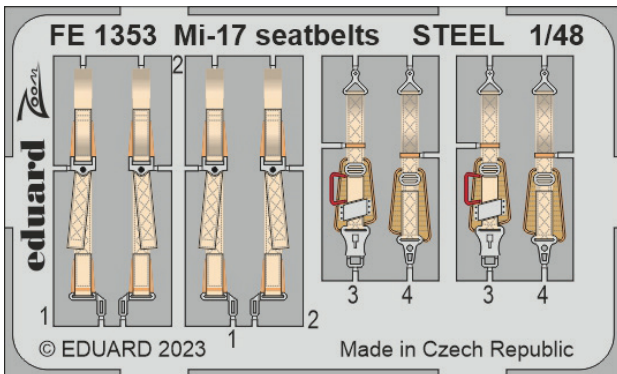

SS801 MiG-21MF interceptor WEEKEND  
1/72 Eduard

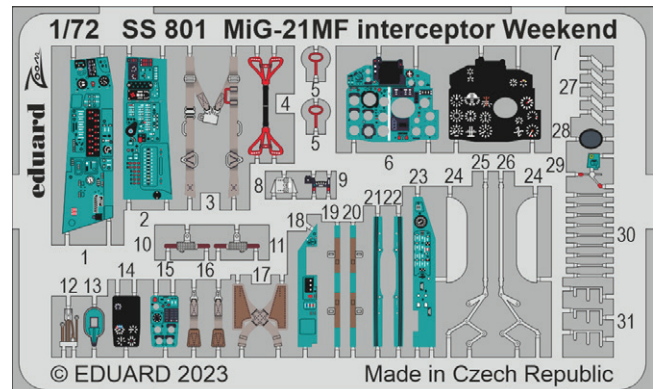

## 634033 Hurricane Mk.IIb Löök 1/32 Revell

Löök set - Brassin pre-painted dashboard and STEEL seatbelts for Hurricane Mk.II in 1/32 scale. Easy to assemble, replaces plastic parts. Recommended kit: Revell

Set contains:

- resin: 1 part
- decals: no
- photo-etched details: yes, pre-painted
- painting mask: no

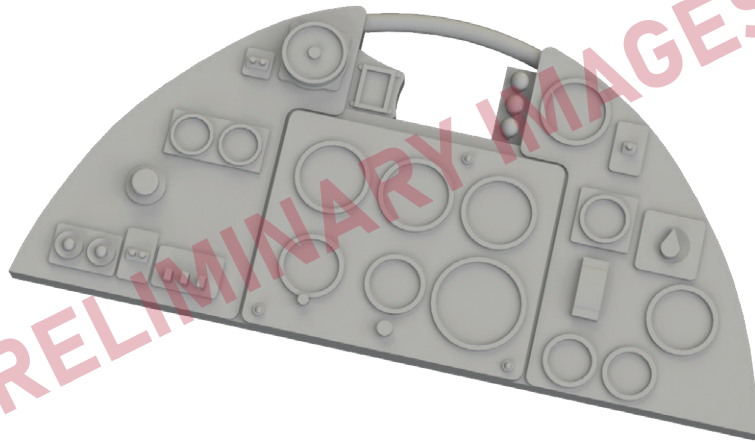
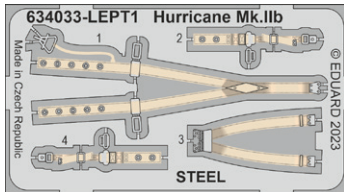

## 634034 Spitfire Mk.IXc Löök 1/24 Airfix

Löök set - Brassin pre-painted dashboard and STEEL seatbelts for Spitfire Mk.IXc in 1/24 scale. Easy to assemble, replaces plastic parts. Recommended kit: Airfix

Set contains:

- resin: 1 part
- decals: no
- photo-etched details: yes, pre-painted
- painting mask: no

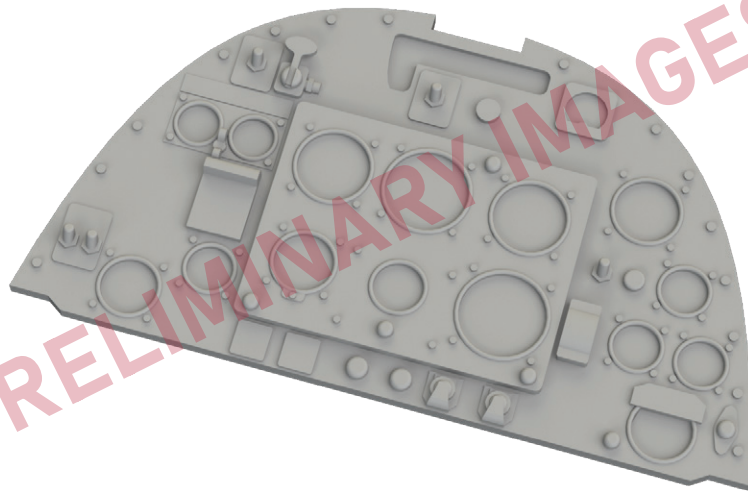
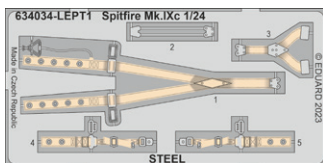

## 644211 F-16A MLU Löök 1/48 Kinetic

Löök set - Brassin pre-painted dashboard and STEEL seatbelts for F-16A MLU in 1/48 scale. Easy to assemble, replaces plastic parts. Recommended kit: Kinetic

Set contains:

- resin: 3 parts
- decals: no
- photo-etched details: yes, pre-painted
- painting mask: no



**644212 F-16C Block 42 till 2005 LööK 1/48 Kinetic**

LööK set - Brassin pre-painted dashboard and STEEL seatbelts for F-16C Block 42 in 1/48 scale. Easy to assemble, replaces plastic parts. Recommended kit: Kinetic

Set contains:

- resin: 3 parts
- decals: no
- photo-etched details: yes, pre-painted
- painting mask: no



**644213 F-16C Block 42 from 2006 LööK 1/48 Kinetic**

LööK set - Brassin pre-painted dashboard and STEEL seatbelts for F-16C Block 42 in 1/48 scale. Easy to assemble, replaces plastic parts. Recommended kit: Kinetic

Set contains:

- resin: 3 parts
- decals: no
- photo-etched details: yes, pre-painted
- painting mask: no



**624003 Spitfire Mk.IX exhaust fishtail PRINT 1/24 Airfix**

Brassin set - exhaust stacks for Spitfire Mk.IXc in 1/24 scale. Made by direct 3D printing. Easy to assemble, replaces plastic parts. Recommended kit: Airfix

Set contains:

- 3D print: 12 parts
- decals: no
- photo-etched details: no
- painting mask: no



### 632191 Luftwaffe rudder pedals PRINT 1/32 Revell

Brassin set - rudder pedals for German WWII aircraft in 1/32 scale. The set consists of 3 pairs of pedals. Made by direct 3D printing. Easy to assemble, replaces plastic parts.

eduard  
**BRASSIN**  
*Print*

Set contains:

- 3D print: 6 parts
- decals: no
- photo-etched details: no
- painting mask: no



### 635027 WWII German towing cable eyes PRINT 1/35

Brassin set - towing cable eyes for German WWII AFV in 1/35 scale. The set consists of 10 eyes. Made by direct 3D printing.

Set contains:

- 3D print: 10 parts
- decals: no
- photo-etched details: no
- painting mask: no

eduard  
**BRASSIN**  
*Print*

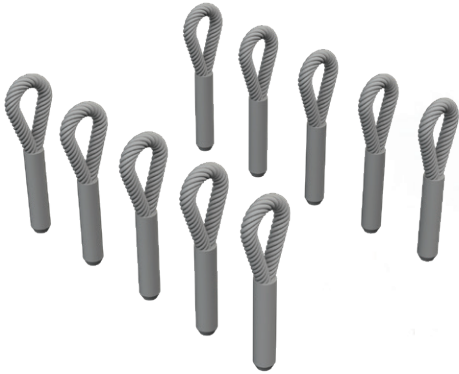

### 635028 WWII German trench binoculars PRINT 1/35

Brassin set - German WWII trench binoculars in 1/35 scale. The set consists of 5 binoculars. Made by direct 3D printing.

Set contains:

- 3D print: 5 parts
- decals: no
- photo-etched details: no
- painting mask: no

eduard  
**BRASSIN**  
*Print*

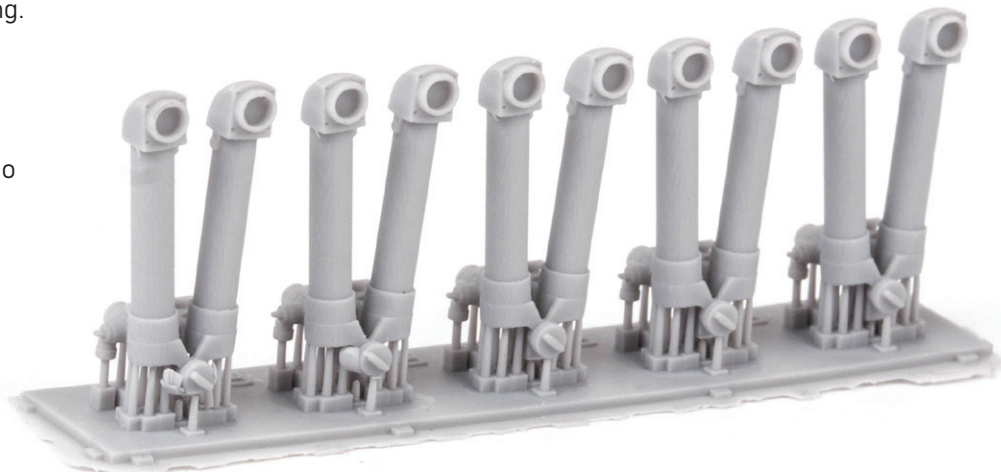

**648827 F4F-3A engine PRINT 1/48 Eduard**

Brassin set - the engine for F4F-3A in 1/48 scale.  
The cowlings are included. Made by direct 3D printing.  
Recommended kit: Eduard



Set contains:

- 3D print: 29 parts
- decals: no
- photo-etched details: yes
- painting mask: no

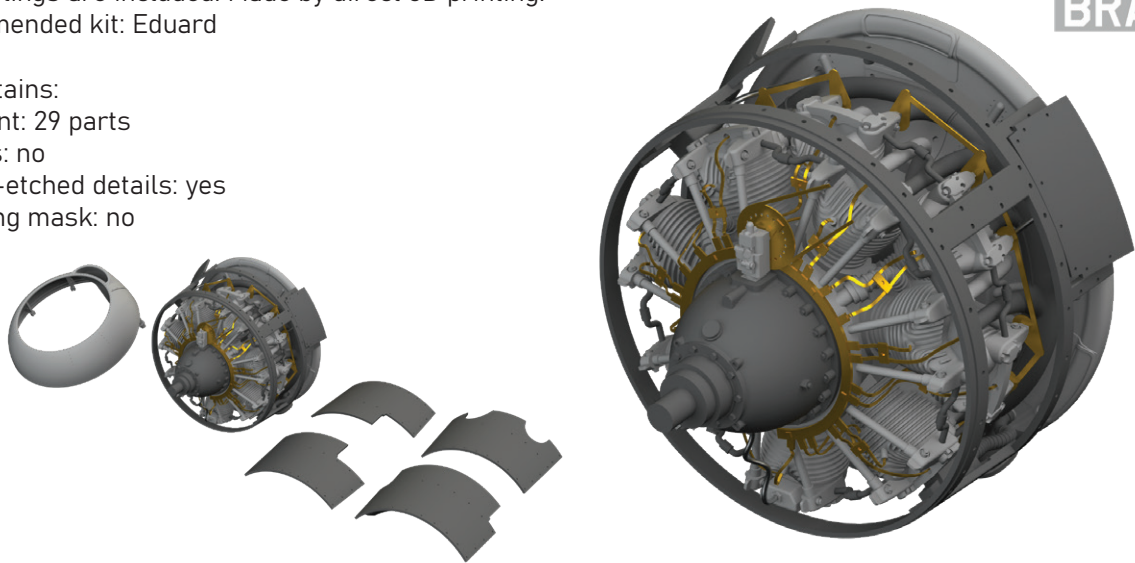

**648850 A6M2-N Rufe cockpit PRINT 1/48 Eduard**

Brassin set - cockpit for A6M2-N in 1/48 scale.  
Made by direct 3D printing. Recommended kit: Eduard

Set contains:

- 3D print: 28 parts
- decals: yes,
- photo-etched details: yes, pre-painted
- painting mask: no
- SPACE 3D decals: no

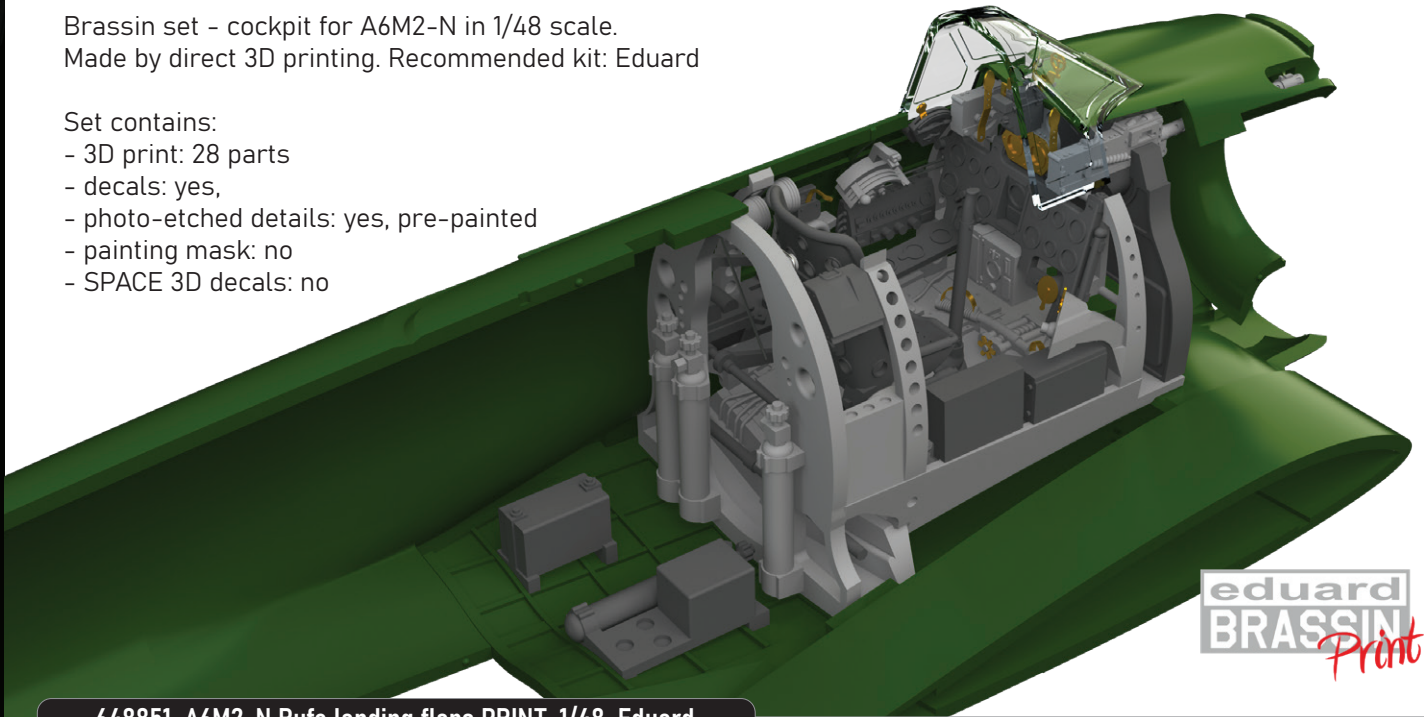

**648851 A6M2-N Rufe landing flaps PRINT 1/48 Eduard**

Brassin set - landing flaps for A6M2-N Rufe  
in 1/48 scale. Made by direct 3D printing.  
Recommended kit: Eduard

Set contains:

- 3D print: 6 parts
- decals: no
- photo-etched details: yes
- painting mask: no

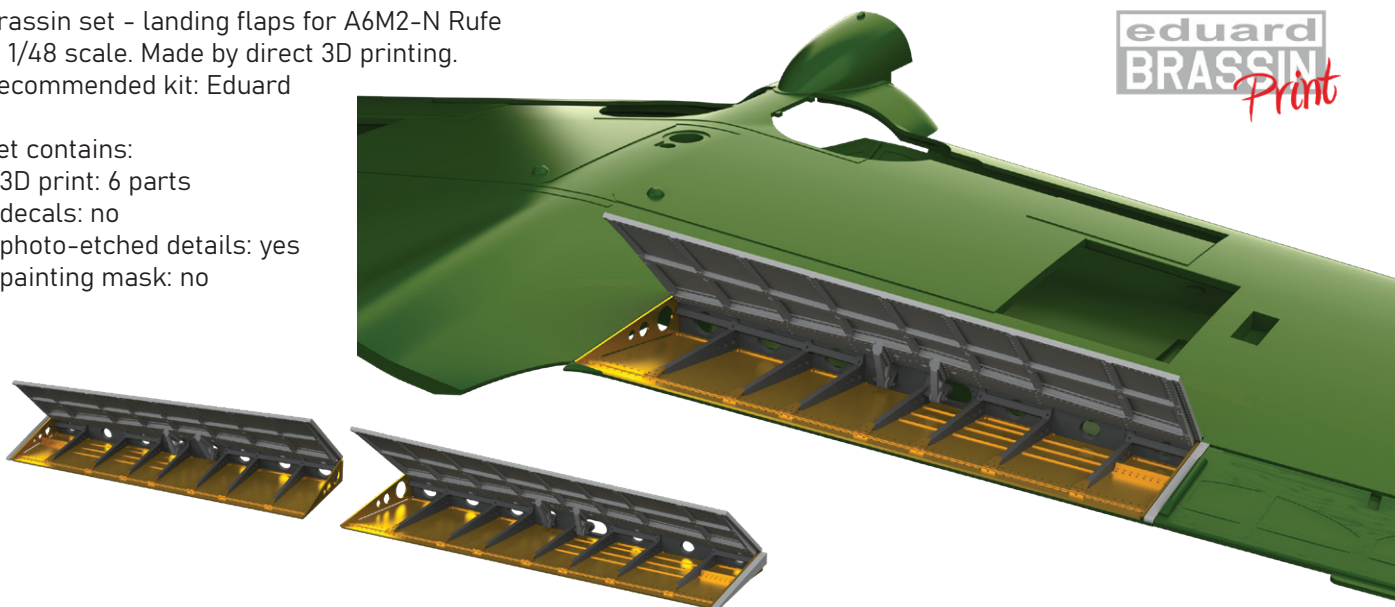



**648852 A6M2-N Rufe engine complete PRINT 1/48 Eduard**

Brassin set - the engine for A6M2-N in 1/48 scale.  
The separate cowlings are included. Made by direct 3D printing. Recommended kit: Eduard

Set contains:

- 3D print: 24 parts
- decals: no
- photo-etched details: yes
- painting mask: no

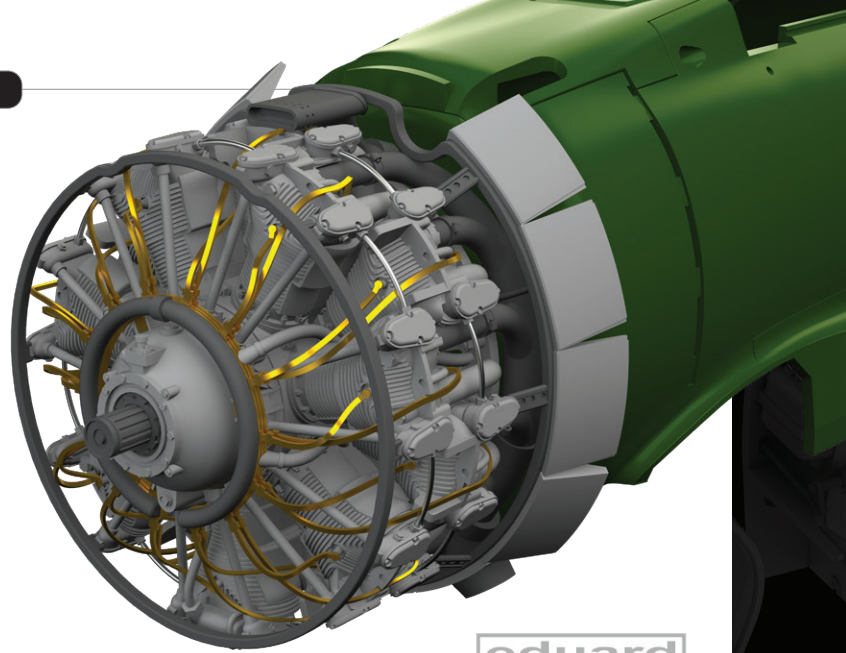
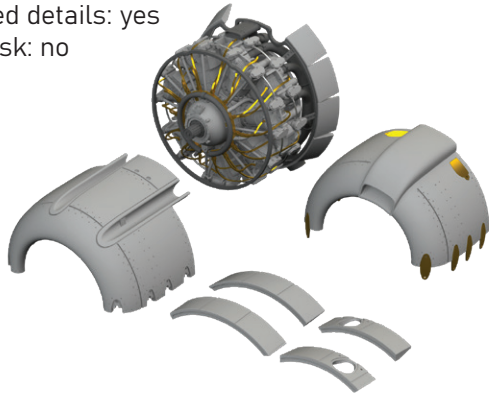

eduard  
BRASSIN  
*Print*

**648853 F4F-4 gun bays PRINT 1/48 Eduard**

Brassin set - gun bays for F4F-4 in 1/48 scale.  
The set consists of gun bays for both wings.  
Made by direct 3D printing. Recommended kit: Eduard

Set contains:

- 3D print: 26 parts
- decals: no
- photo-etched details: yes
- painting mask: no

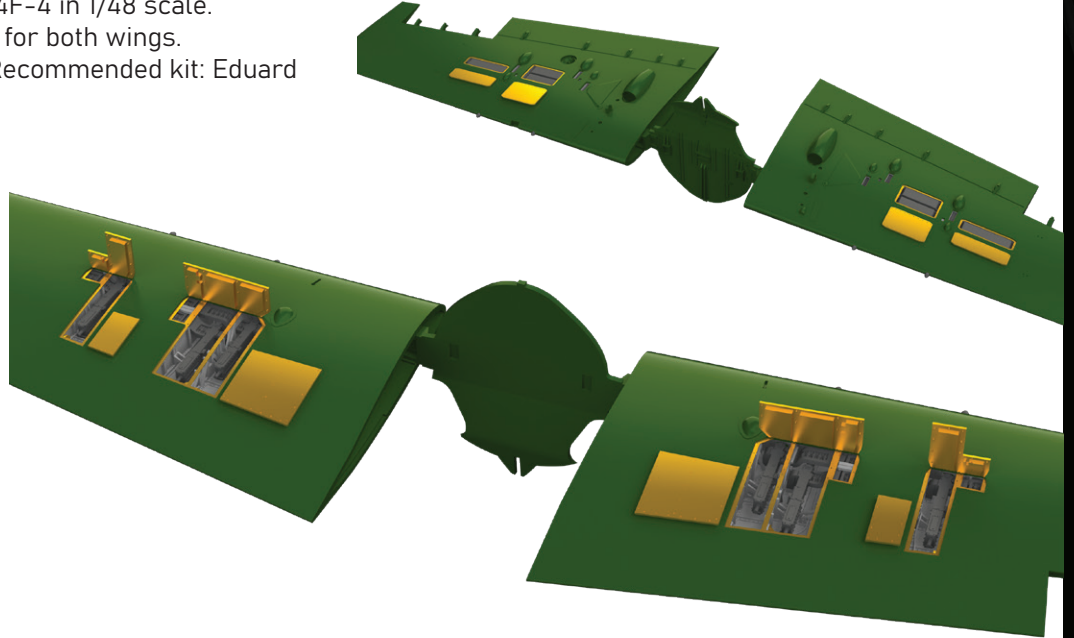

eduard  
BRASSIN  
*Print*

**648856 F-16 radar late PRINT 1/48 Kinetic**

Brassin set - nose radar for F-16 in 1/48 scale.  
Made by direct 3D printing. Recommended kit: Kinetic

Set contains:

- 3D print: 5 parts
- decals: no
- photo-etched details: yes
- painting mask: no

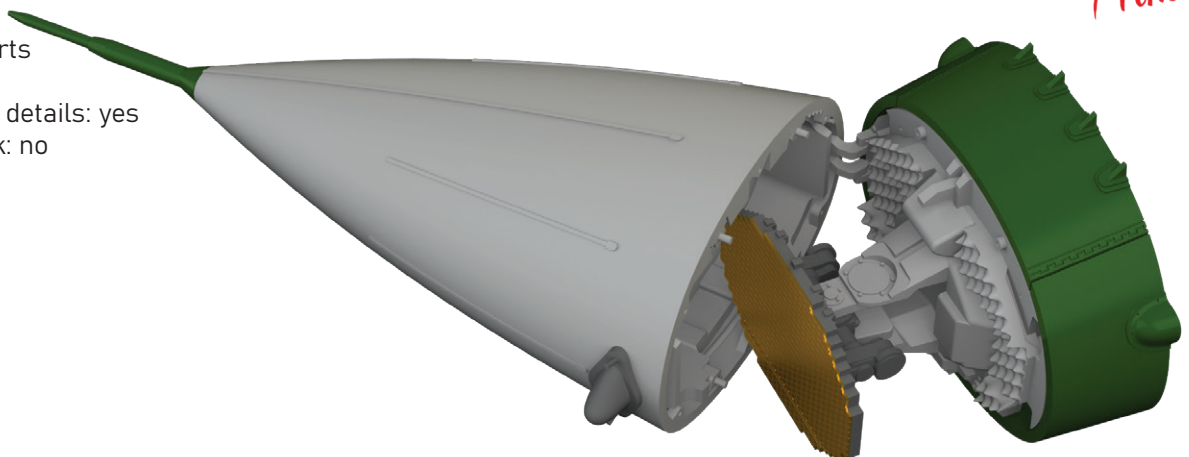

eduard  
BRASSIN  
*Print*

### 648858 F-35A ejection seat PRINT 1/48 Tamiya

Brassin set - ejection seat for F-35A in 1/48 scale.  
Easy to assemble, replaces plastic parts.  
Made by direct 3D printing.  
Recommended kit: Tamiya

Set contains:

- 3D print: 9 parts
- decals: yes
- photo-etched details: yes, pre-painted
- painting mask: no

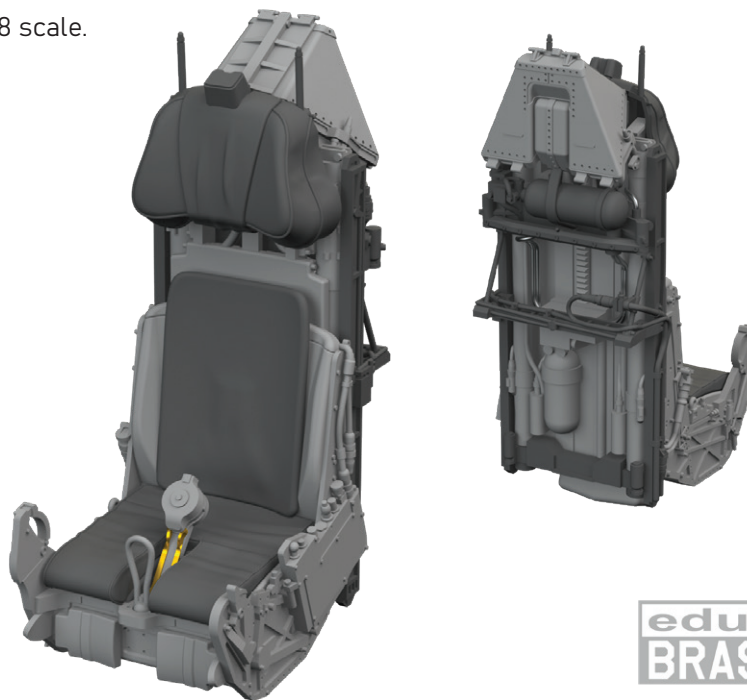
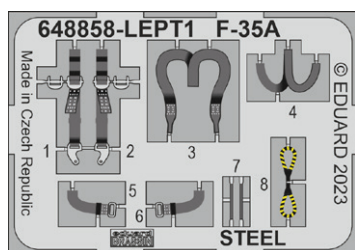

eduard  
BRASSIN  
*Print*

### 648860 F-35A exhaust nozzle PRINT 1/48 Tamiya

Brassin set - exhaust nozzle for F-35A in 1/48 scale.  
Made by direct 3D printing. Easy to assemble, replaces plastic parts. Recommended kit: Tamiya

Set contains:

- 3D print: 4 parts
- decals: no
- photo-etched details: no
- painting mask: no

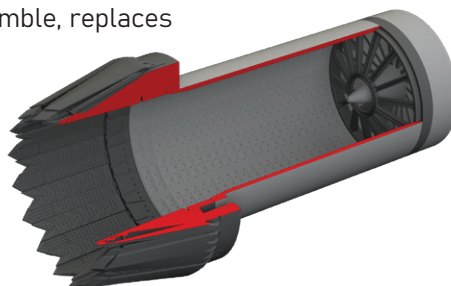

eduard  
BRASSIN  
*Print*



### 648861 Vickers 97-cartridges ammo magazines PRINT 1/48

Brassin set - ammunition magazines for Vickers guns in 1/48 scale. The set consists of 12 magazines.  
Made by direct 3D printing.

Set contains:

- 3D print: 12 parts
- decals: no
- photo-etched details: no
- painting mask: no

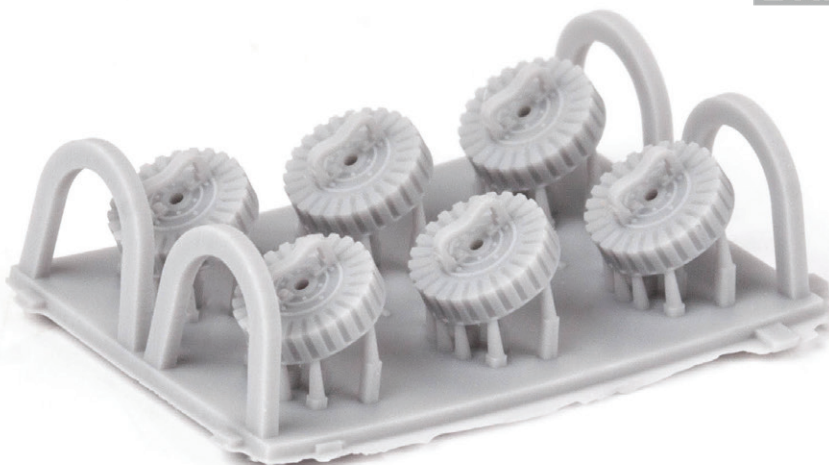

eduard  
BRASSIN  
*Print*

644208 A6M2-N Rufe LööKplus 1/48 Eduard

Collection of 4 sets for A6M2-N Rufe in 1/48 scale.  
Recommended kit: Eduard

- LööK set (pre-painted Brassin dashboards & Steelbelts)
- TFace painting mask
- exhaust pipes
- seat

LööK

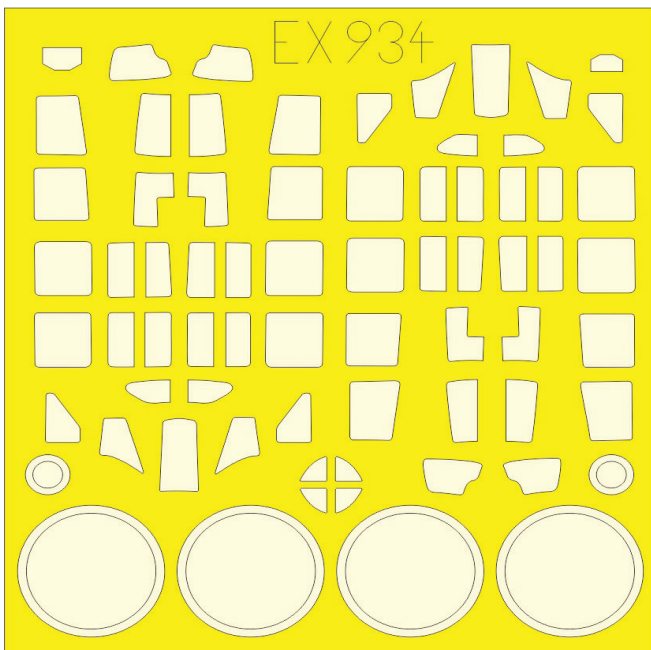
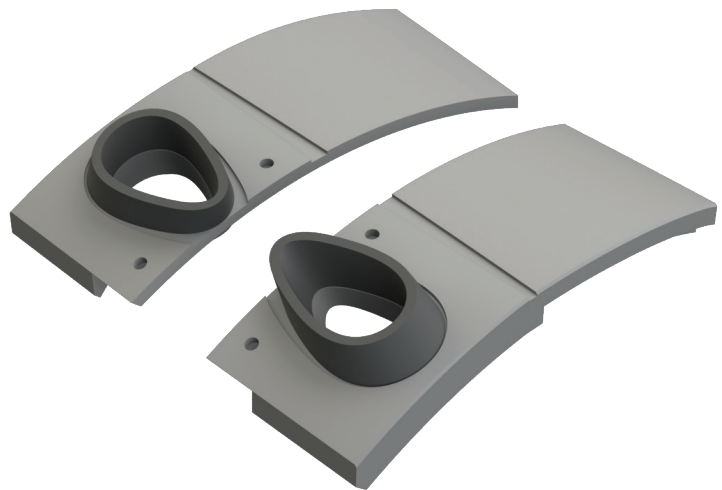
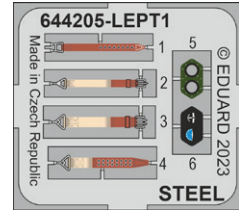
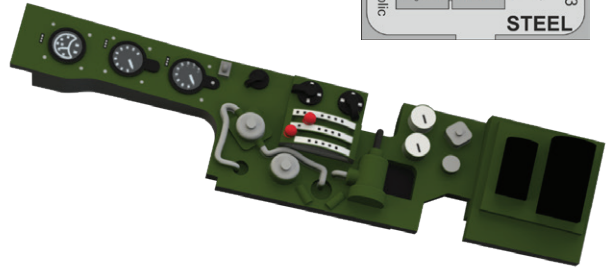
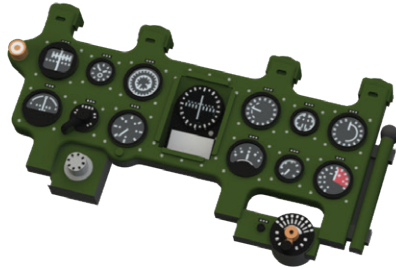

## 644209 Mosquito B Mk.IV LööKplus 1/48 Tamiya

Collection of 3 sets for Mosquito B Mk.IV in 1/48 scale.  
Recommended kit: Tamiya

- LööK set (pre-painted Brassin dashboards & Steelbelts)
- TFace painting mask
- undercarriage wheels

# LööKt

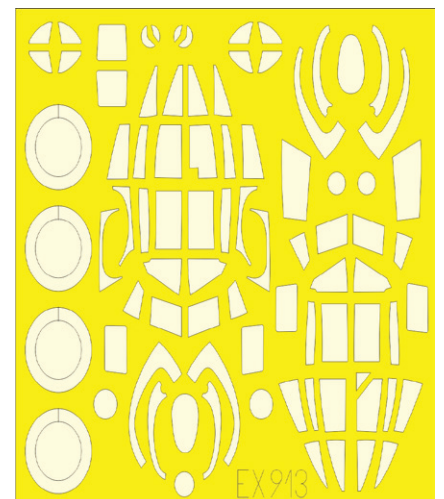
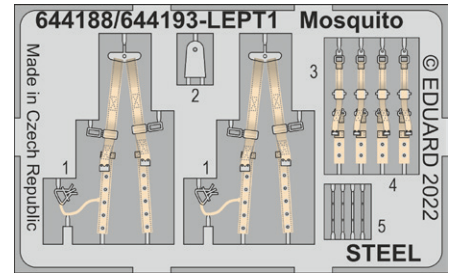

644210 F-16C Block 25 LööKplus 1/48 Kinetic

Collection of 4 sets for F-16C Block 25 in 1/48 scale.  
Recommended kit: Kinetic

- LööK set (pre-painted Brassin dashboards & Steelbelts)
- TFace painting mask
- undercarriage wheels
- ejection seat

LööK+

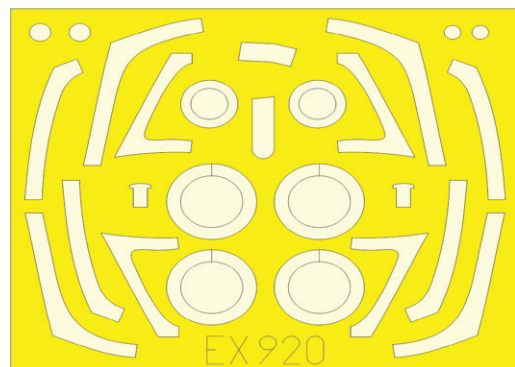
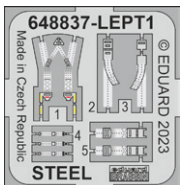
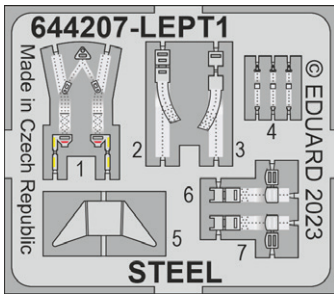
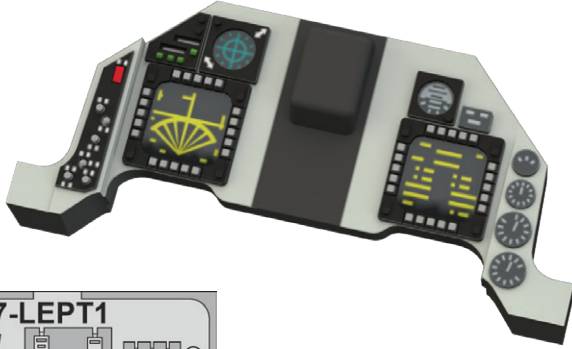

SIN648103 F4F-4 ESSENTIAL 1/48 Eduard

Collection of 4 sets for F4F-4 in 1/48 scale.  
Recommended kit: Eduard

- cockpit
- undercarriage legs BRONZE
- undercarriage wheels
- exhaust pipes

All sets included in this BIG SIN are available separately,  
but with every BIG SIN set you save up to 30 %.

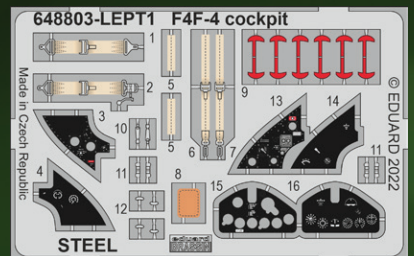
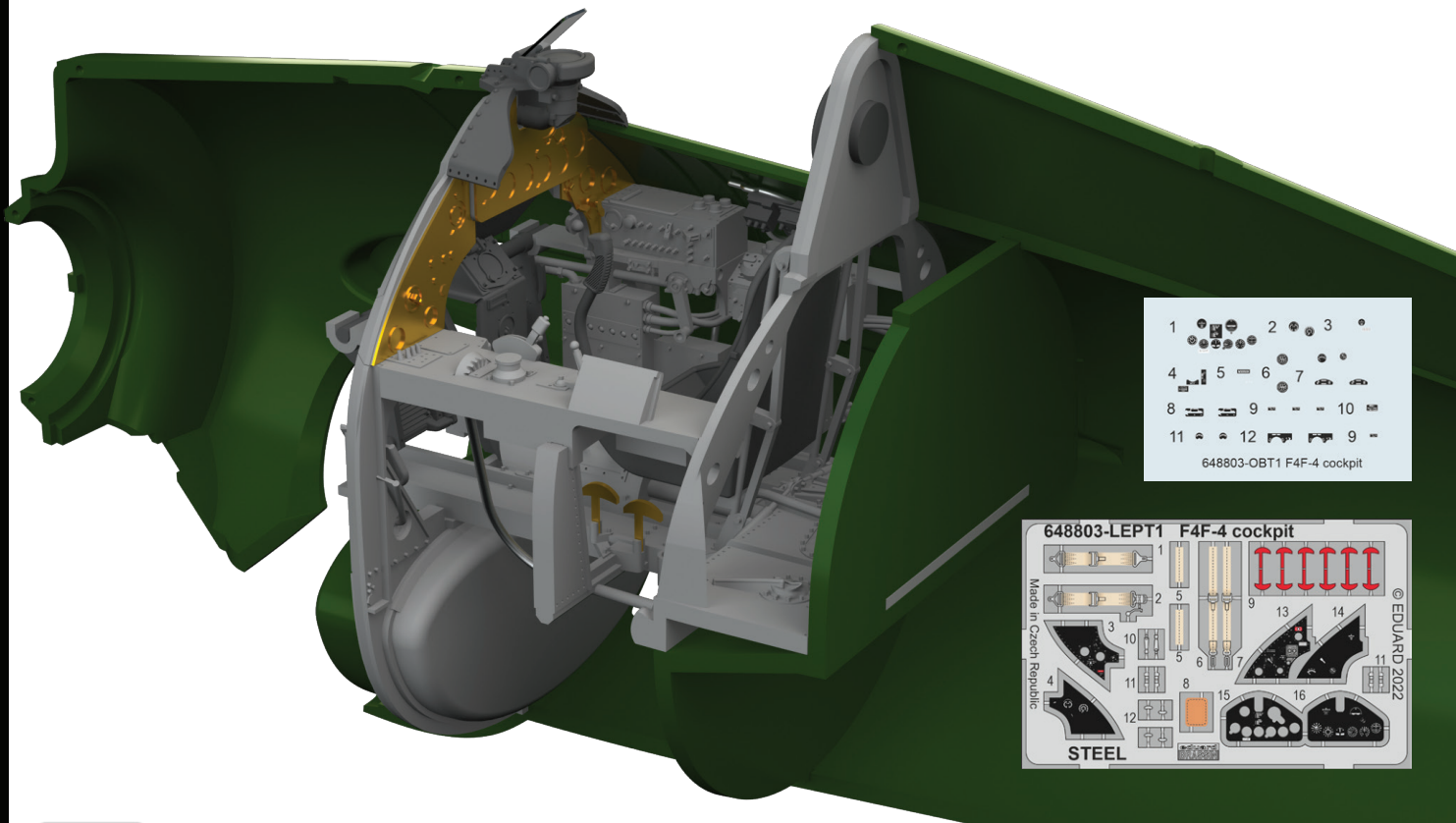
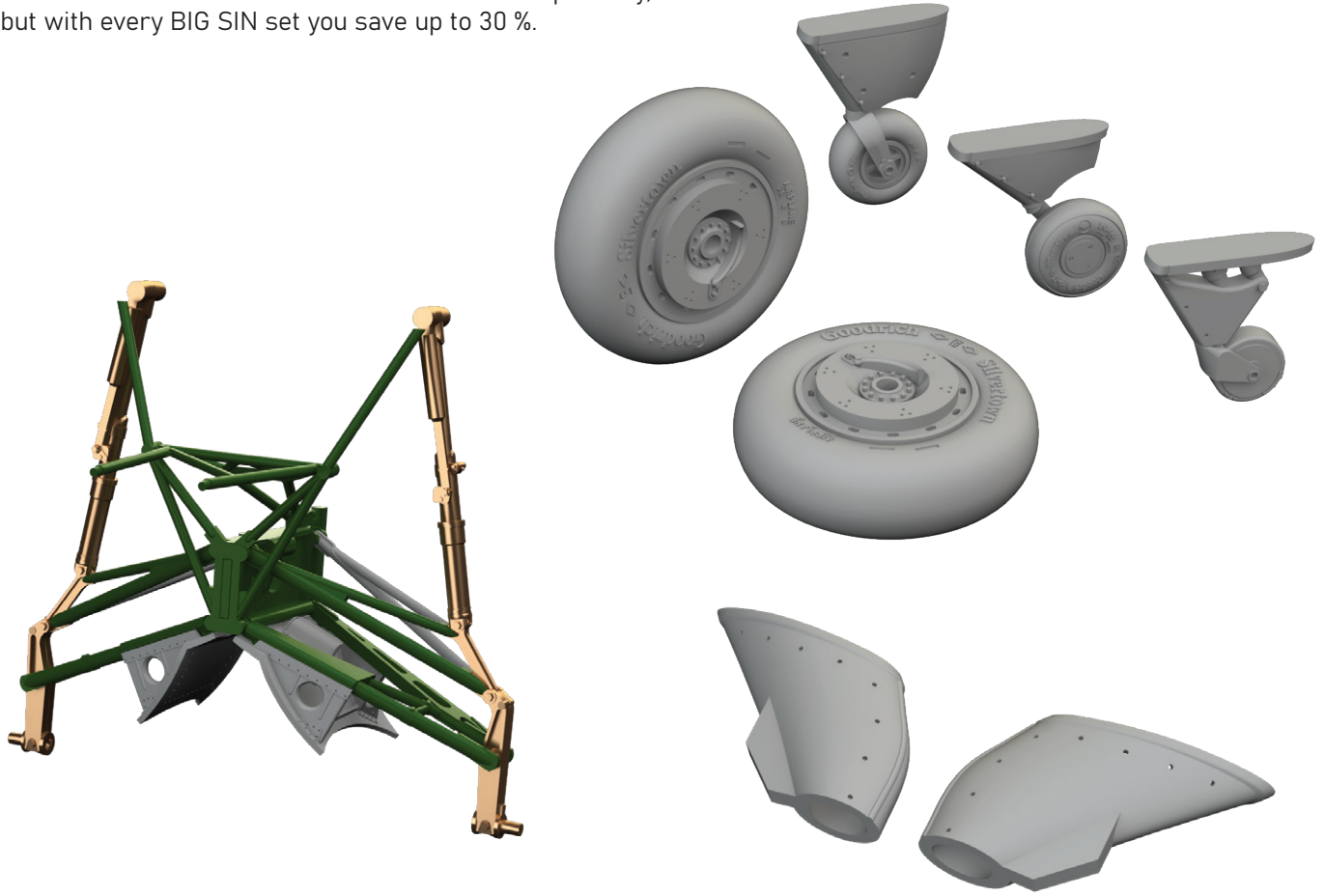

## SIN648104 F-16 armament w/ laser guided bombs 1/48 Kinetic

Collection of 8 sets for F-16 in 1/48 scale.  
Recommended kit: Kinetic

- AN/AAQ-28(V) Litening pod
- AIM-120C AMRAAM
- GBU-12 bomb (2 sets)
- Sniper ATP
- AN/ALQ-131 (deep) ECM pod
- GBU-49
- AIM-9M/L Sidewinder

All sets included in this BIG SIN are available separately,  
but with every BIG SIN set you save up to 30 %.

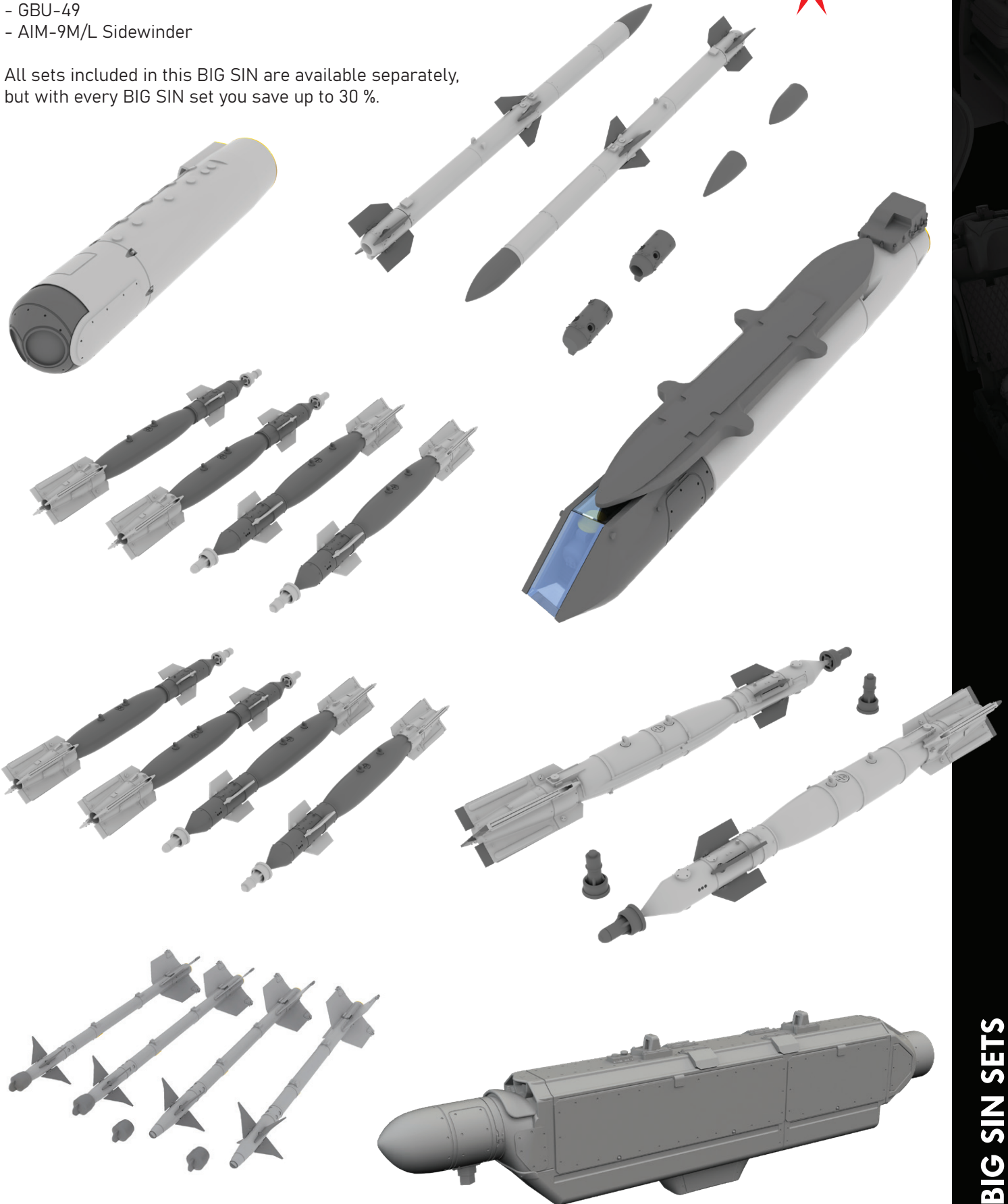

D48112 Angel of Mercy  
1/48 HKM

B-25J-10-NC, 43-35982, 428th BS, 310th BG, 12th AF, Ghisonaccia, Corsica, France, April 1945

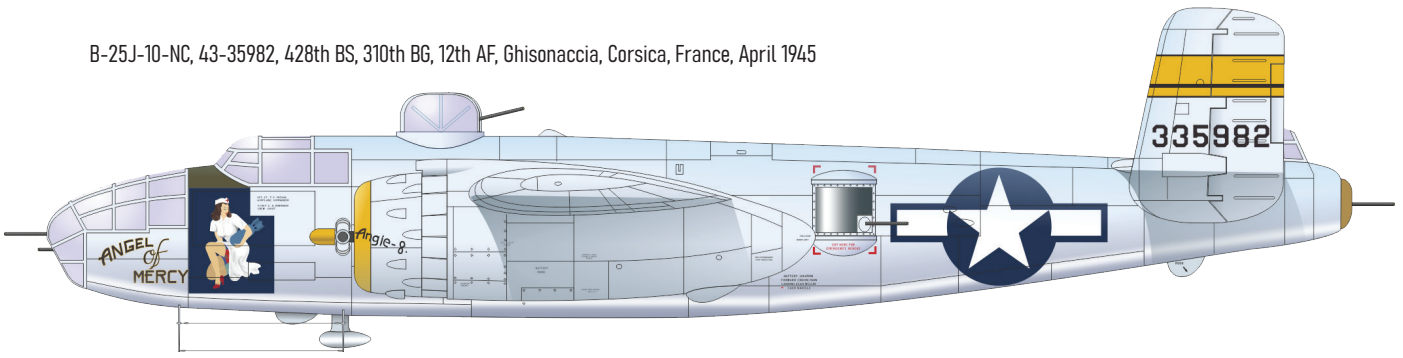

B-25J-1-NC, 43-27716, 445th BS, 321st BG 12th AF, Solenzara, Corsica, France, April 1945

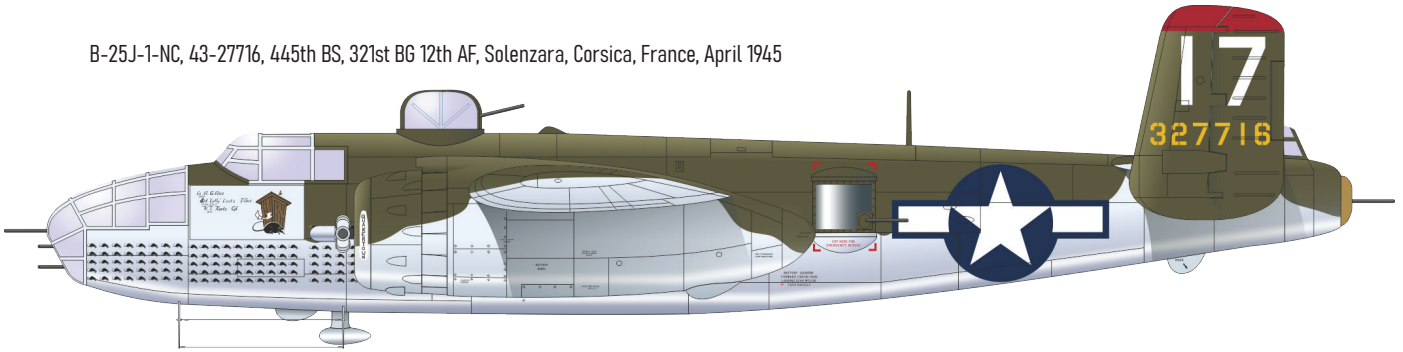

B-25J-1-NC, 43-3890, 82nd BS, 12th BG, 10th AF, Fenny, India, December 1945

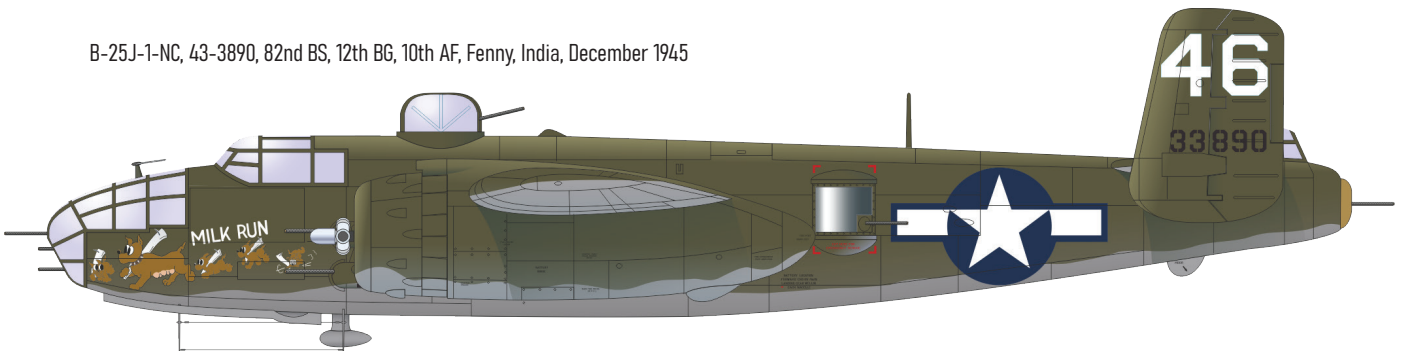

B-25J-10-NC, 43-36020, 501st BS, 345th BG, 5th AF, Tacloban, Philippines, April 1945

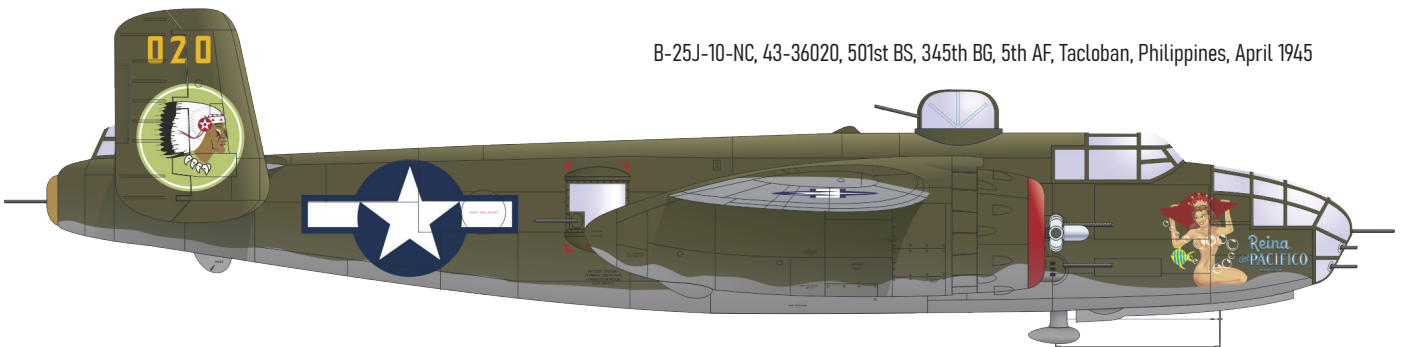

B-25J-5, 43-27952, 823rd BS, 38th BG, 5th AF, Morotai, Indonesia, November 1944

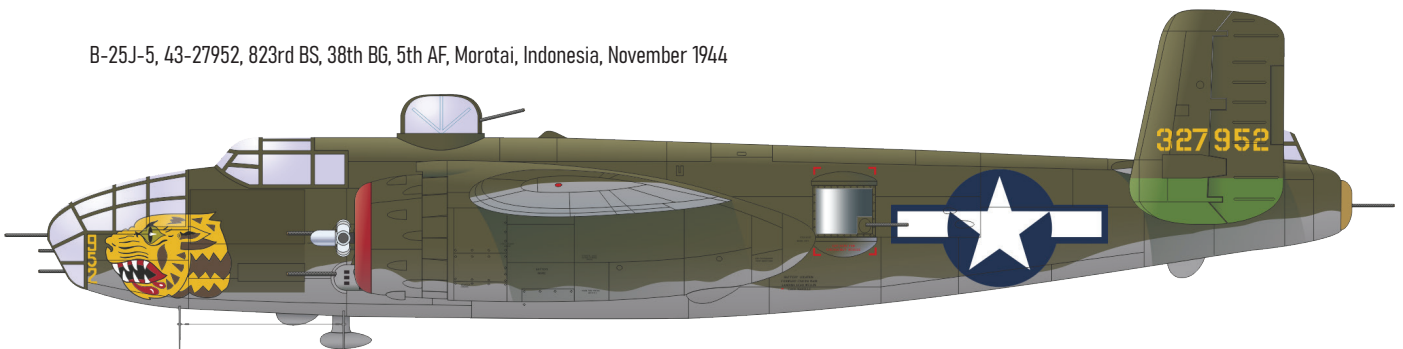



**BIG49363 Anson Mk.I 1/48 Airfix**

- 481099 Anson Mk.I landing flaps 1/48
- 481100 Anson Mk.I bomb bays 1/48
- 491326 Anson Mk.I 1/48
- FE1327 Anson Mk.I seatbelts STEEL 1/48
- EX917 Anson Mk.I 1/48

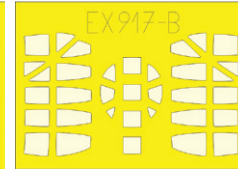
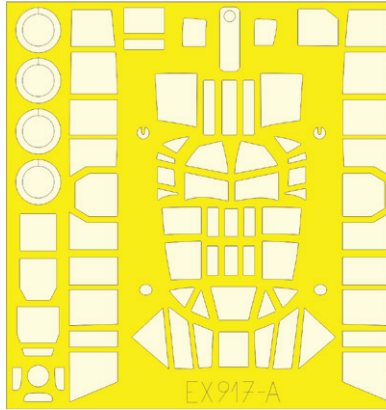
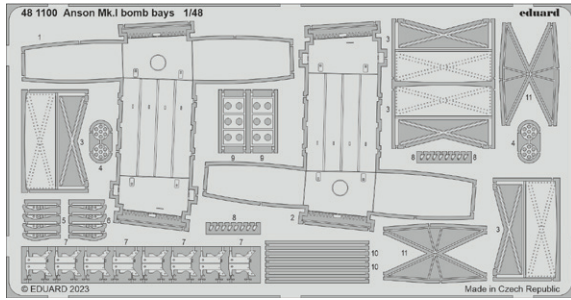
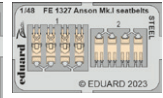
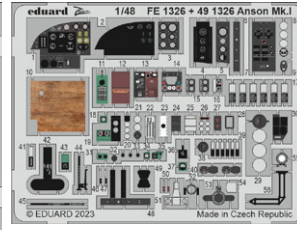
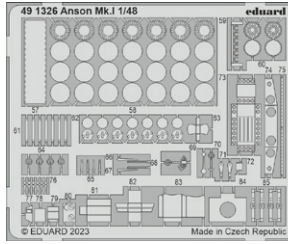
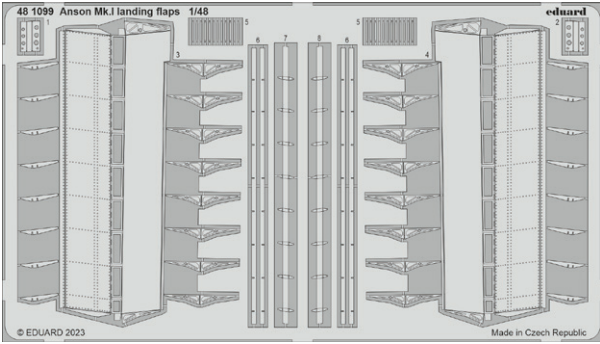

**BIG49364 F-16C Block 25 1/48 Kinetic**

- 49103 Remove Before Flight STEEL
- 491328 F-16C Block 25 1/48
- FE1331 F-16C Block 25/42 seatbelts STEEL 1/48
- EX919 F-16C Block 25/42 1/48

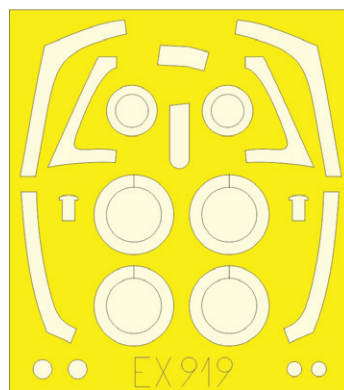
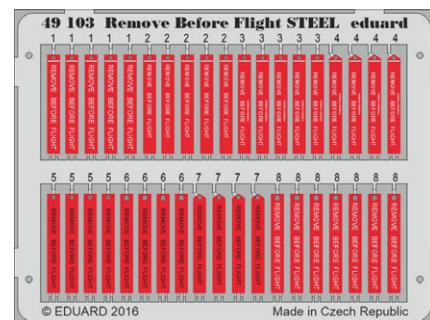
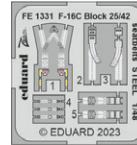
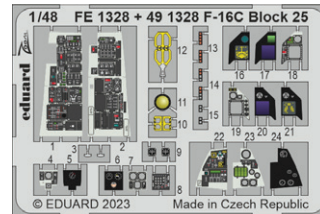
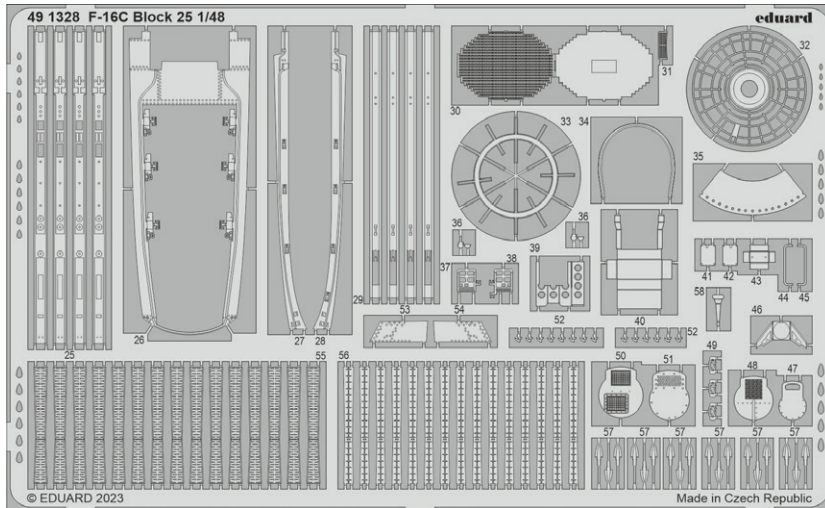

**BIG49365 F-16C Block 42 till 2005 1/48 Kinetic**

- 49103 Remove Before Flight STEEL
- 491329 F-16C Block 42 till 2005 1/48
- FE1331 F-16C Block 25/42 seatbelts STEEL 1/48
- EX919 F-16C Block 25/42 1/48

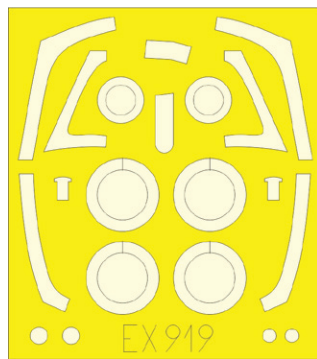
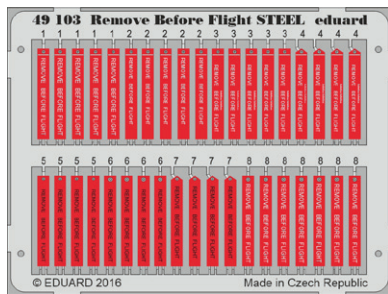
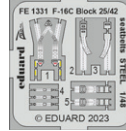
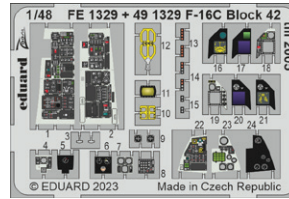
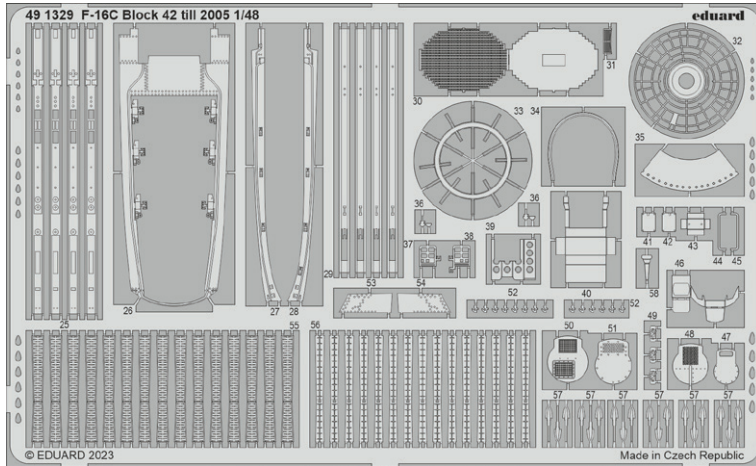

**BIG49366 F-16C Block 42 from 2006 1/48 Kinetic**

- 49103 Remove Before Flight STEEL
- 491330 F-16C Block 42 from 2006 1/48
- FE1331 F-16C Block 25/42 seatbelts STEEL 1/48
- EX919 F-16C Block 25/42 1/48

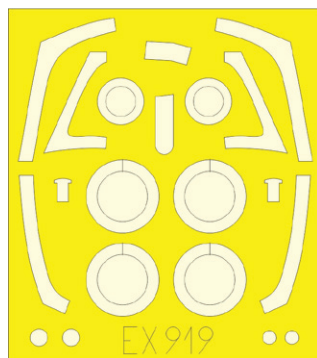
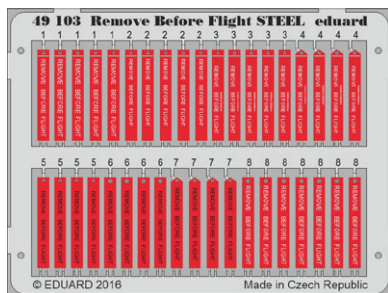
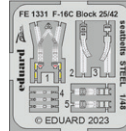
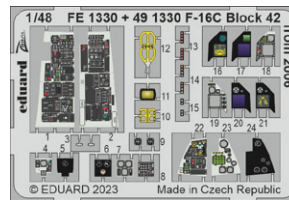
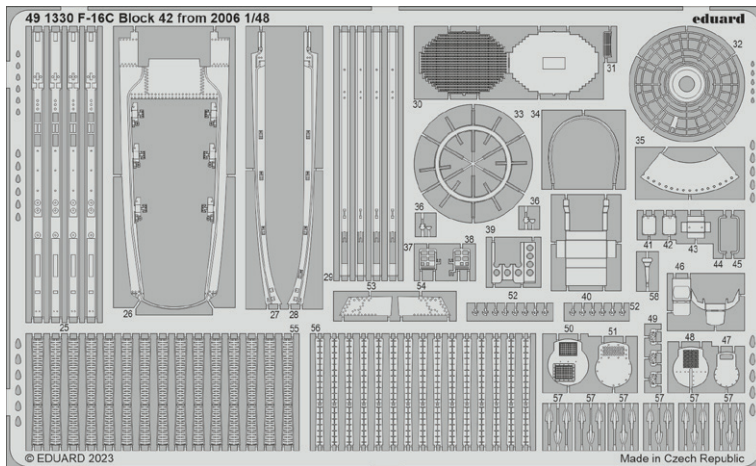

#635024

## WWII German 10 ton jacks PRINT

1/35

Brassin set - 10ton jacks for German WWII AFV in 1/35 scale. The set consists of 3 jacks. Made by direct 3D printing.

Set contains:

- 3D print: 15 parts
- decals: no
- photo-etched details: no
- painting mask: no

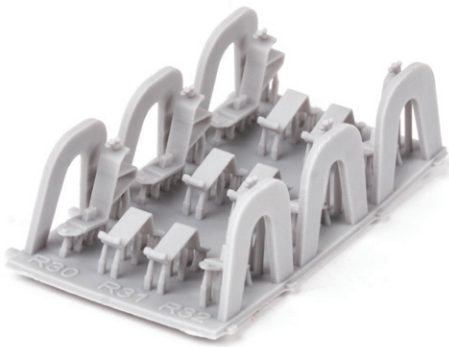

#635026

## WWII German wire cutters PRINT

1/35

Brassin set - wire cutters for German WWII AFV in 1/35 scale. The set consists of 5 wire cutters. Made by direct 3D printing.

Set contains:

- 3D print: 5 parts
- decals: no
- photo-etched details: yes
- painting mask: no

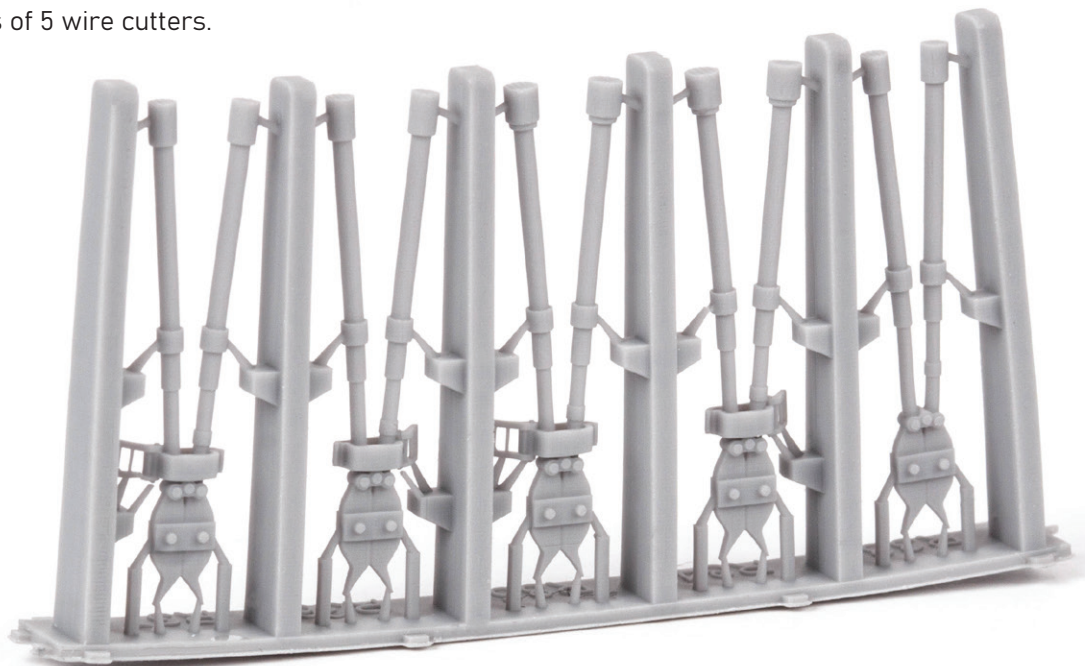

#648857

# Mi-24V cockpit turquoise PRINT & SPACE

1/48 Eduard

Brassin set - turquoise-painted cockpit for Mi-24V in 1/48 scale.  
Made by direct 3D printing. Recommended kit: Eduard / Zvezda

Set contains:

- 3D print: 10 parts
- resin: 46 parts
- decals: no
- photo-etched details: yes, pre-painted
- painting mask: no
- SPACE 3D decals: yes

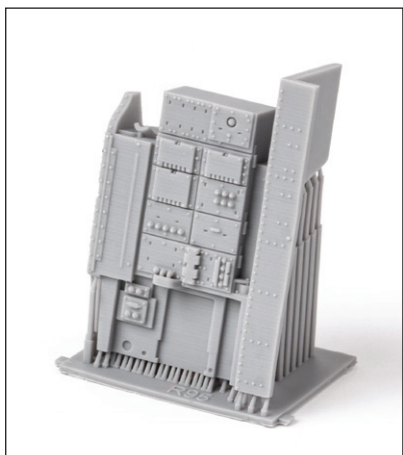
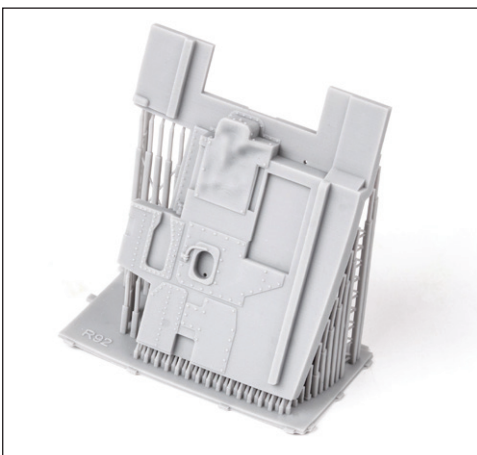
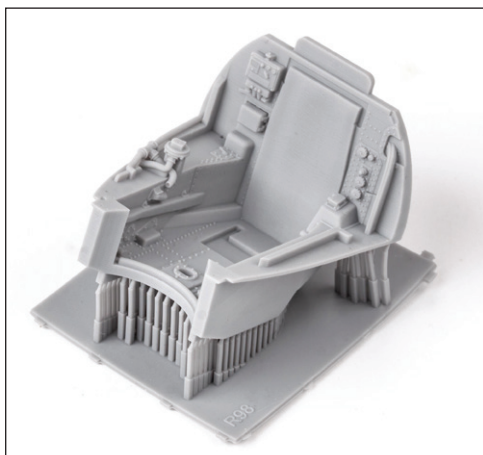
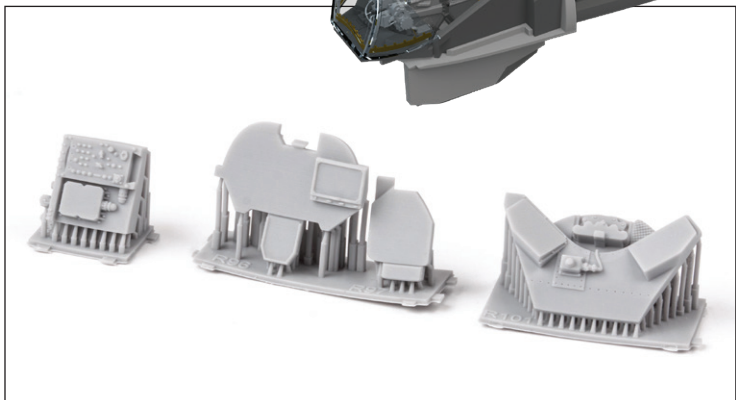
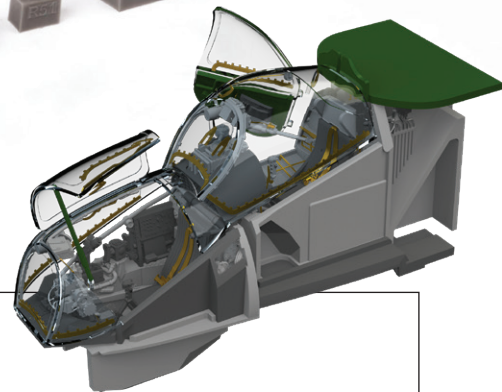
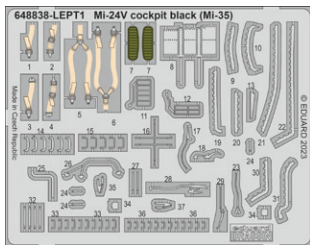
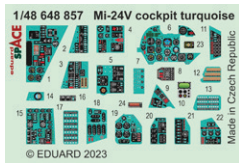

**eduard**

# Bf 110C 1/48

**ProfiPACK**  
edition

ProfiPACK edition kit of German WWII twin-engine heavy fighter aircraft Messerschmitt Bf 110C in 1/48 scale. This version was used as a day and night fighter.

**WILD CARDS** 



Bf 110C-2, WNr. 3578, 9./ZG 26, Barty, France, August 1940



Bf 110C-4, WNr. 2095, 4./ZG 1, Trier-Euren, Germany, June 1940



Bf 110C-2, WNr. 3257, Hptm. Heinz Wagner/Stfw. Adolf Schmidt, CO of 4./ZG 76, Abbeville, France, August 1940

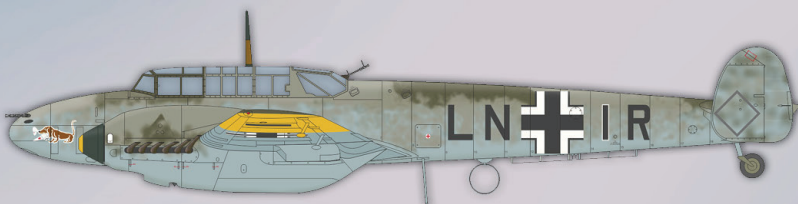

Bf 110C-2, WNr. 3026, Lt. K. Koch, 1.(Z)/JG 77, Kirkenes, Norway, October 1941



Bf 110C, 1./NJG 3, Benghazi, Libya, May 1941

#8209

[www.eduard.com](http://www.eduard.com)

eduard

WILD CARDS 

LIMITED



1/48

*Ryu*

Type 2 Seaplane Fighter  
Nakajima A6M2-N, 1942-1945

- Eduard design and tools 2023
- Focused on aircraft serving in period 1942 - 1945
- Dual Combo - plastic parts, die cut masks and photo-etched details for two complete models
- Decals for 8 marking options

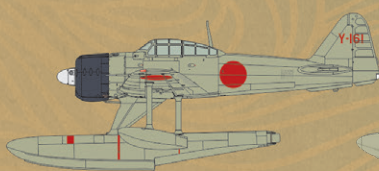

Yokohama Kōkūtai, Tulagi Island,  
Solomon Islands, August 1942

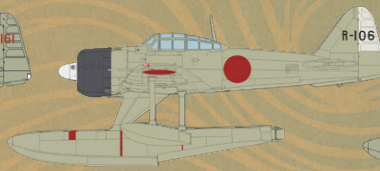

5th Kōkūtai, Kiska island,  
Aleutians, August 1942

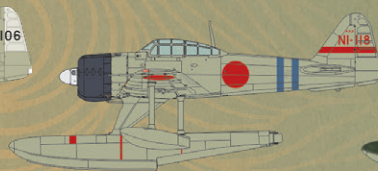

c/n 15, Lt.(jg) Keizō Yamazaki,  
Kōkūtai 802, Shortland Island,  
February 1943



Kōkūtai 802, Faisi-Poporang base,  
Shortland Islands, February 1943

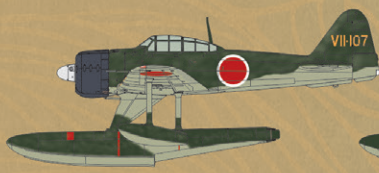

Kōkūtai 452, Bettobi Lake,  
shumshu Islands, Kuriles, July 1943

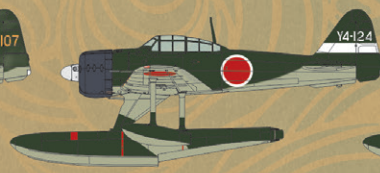

Kōkūtai 802, Emidj Island, Jaluit Atoll,  
Marshall Islands, October 1943



Ensign Jin'ichirō Ozawa, Sasebo Kōkūtai,  
Sasebo Air Base, Japan, September 1944

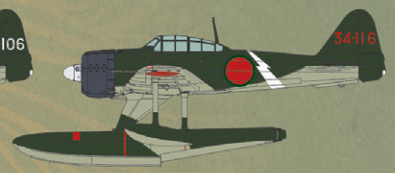

Kōkūtai 934, Ambon island,  
Moluku Islands, March 1944

DUAL COMBO #11171

WWW.EDUARD.COM

- 644205 A6M2-N Rufe LööK (Brassin)
- 648845 A6M2-N Rufe seat PRINT (Brassin)
- 648846 A6M2-N Rufe exhaust PRINT (Brassin)
- 648847 A6M2-N Rufe cannon barrels & cockpit guns PRINT (Brassin)
- 648848 A6M2-N Rufe folding wingtips PRINT (Brassin)
- 648849 A6M2-N Rufe gun bays PRINT (Brassin)
- 3DL48114 A6M2-N Rufe SPACE (3D Decal Set)
- EX934 A6M2-N Rufe TFace (Mask)
- 648850 A6M2-N Rufe cockpit PRINT 1/48 Eduard - Release 05/2023
- 648851 A6M2-N Rufe landing flaps PRINT 1/48 Eduard - Release 05/2023
- 648852 A6M2-N Rufe engine complete PRINT 1/48 Eduard - Release 05/2023

# 648847

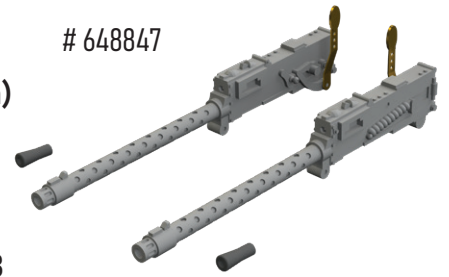

# 644203

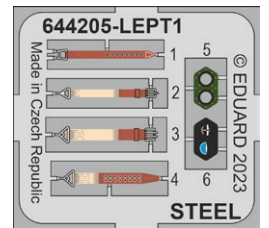

# 648845

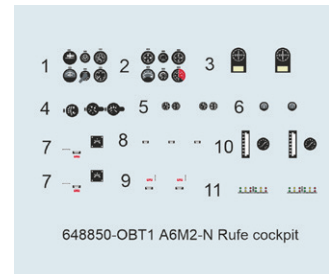
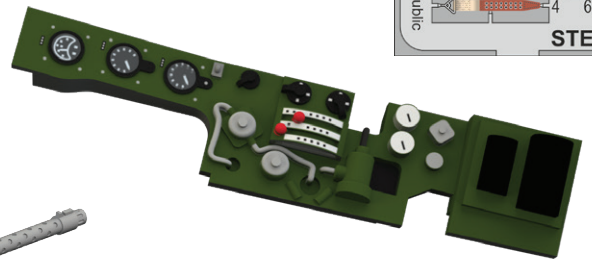

# 648850

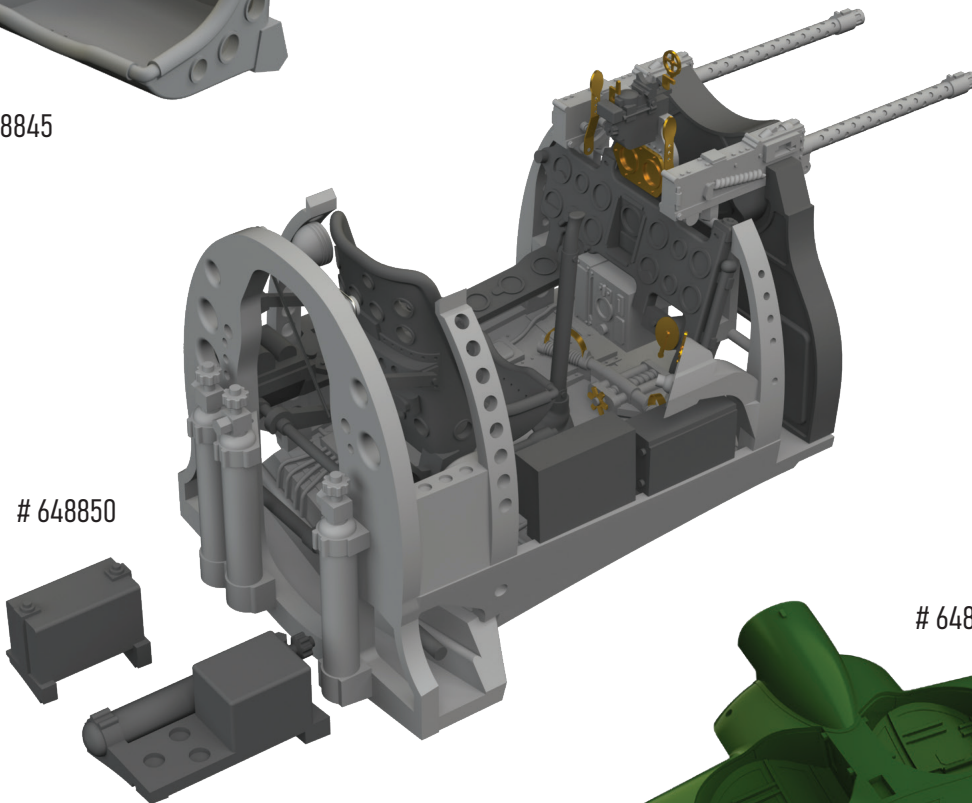

# 648849

# 648846

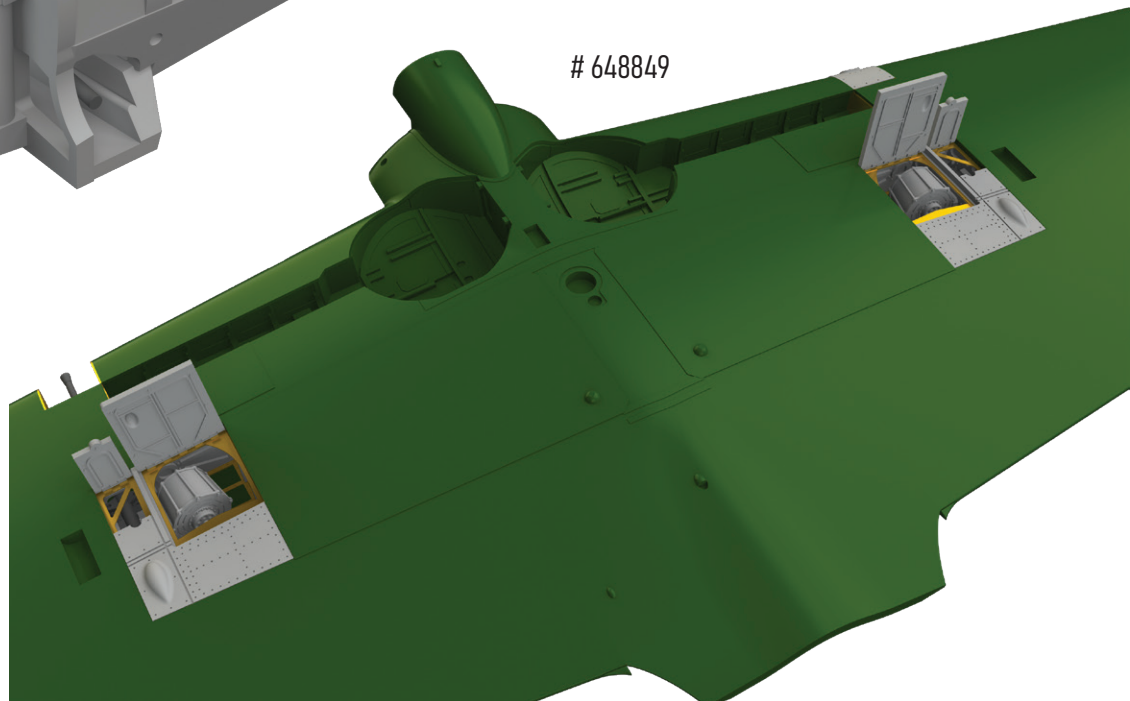
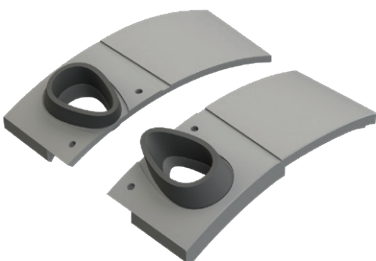

# NEW SPRUES for RUFÉ kit

Sprue G

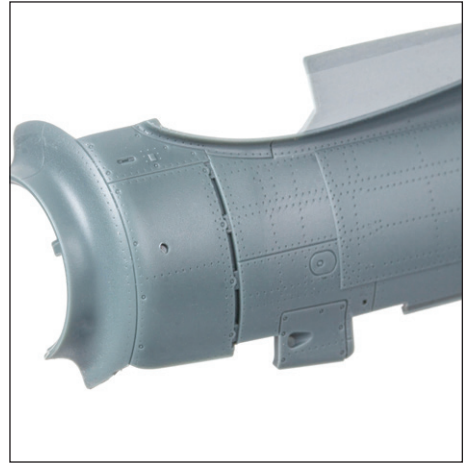
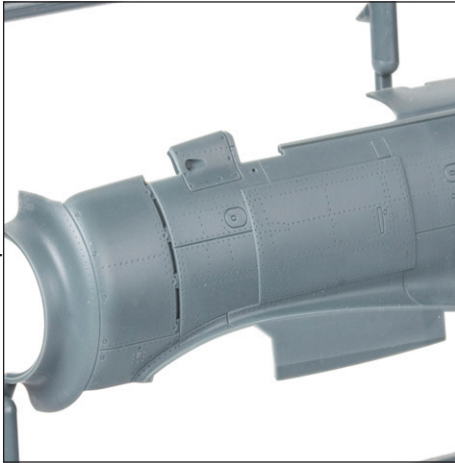

Sprue L

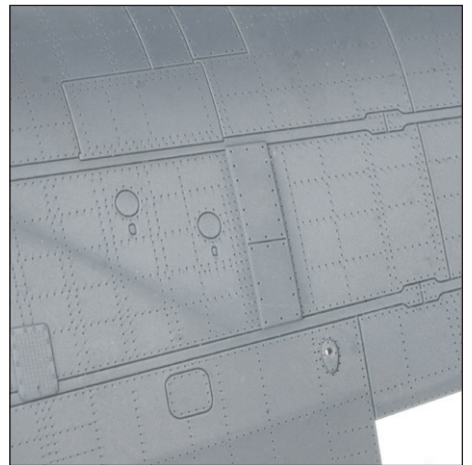
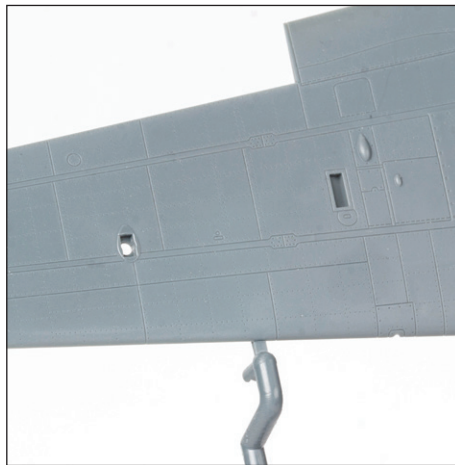

Sprue T

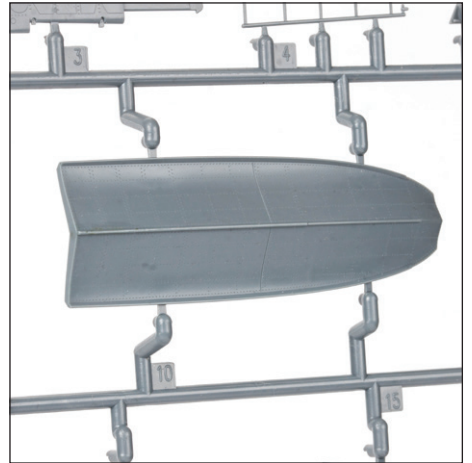
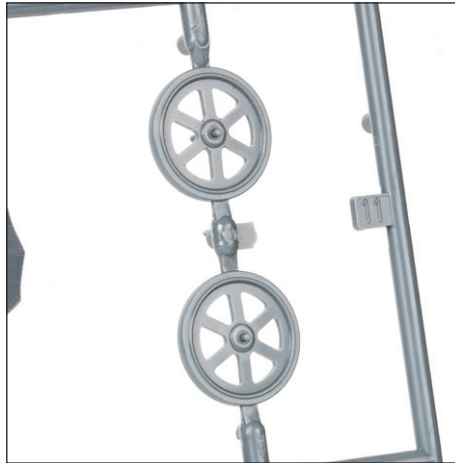
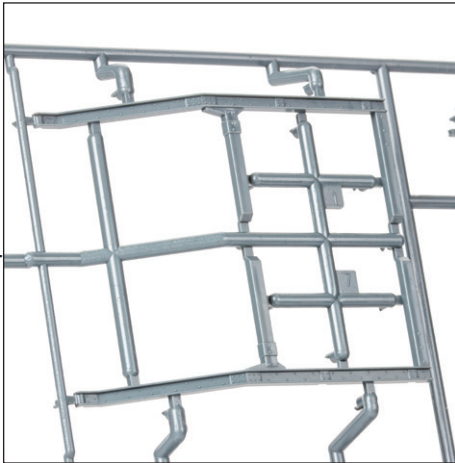

Sprue U

