

Dear friends,
In today's Leaflet you will find the upcoming releases for April 2023.

THE KITS

In April we will release five new kits as new items and one more that was released earlier and not available for some time.

We can expect the biggest hit among them to be the premiere release of the Rufe kit in the 1/48 Limited Edition. As is customary with premiere kits released in this series, it is packaged in Dual Combo mode with two complete sets of moldings for two models of the Japanese A6M2-N Rufe floatplane fighter. The decals will offer the opportunity to build two of the eight Imperial Japanese Navy machines from the 1942 to 1944 battles of the Aleutians, Guadalcanal, Indonesia and Chichi-jima. Although this floatplane was based on design of the A6M2 Zero carrier fighter, and many customers will probably expect it to be just another boxed version of the Zero, this is not the case. While the kit is also structurally based on the Zero, there is an entirely new set of moulds made for it, and the Rufe shares with the other Zero kits sprues for small parts and clear parts only.

In 1/48 scale in the ProfiPACK edition in April we are releasing Z-326/C-305 Trenér Master. The kit features a version of the famous Czechoslovakian trainer and aerobatic plane, equipped with retractable landing gear. The kit also covers the Z-326M and Z-326MF versions, including the military C-305 variant. The kit can be used to build one of six aircraft from Czechoslovakia, Czech Republic, Hungary, Germany and France.

The ProfiPACK edition in 1/48 scale brings back the twin-engined Bf 110C heavy fighter. The kit is based on previously released plastic parts, however as a new item the kit offers new set of markings.

From the WWII era will be released two 1/48 Weekend Edition kits. The first is the Tempest Mk.V Series 2 with a set of decals allowing to build either one of the three machines operating from Volkel in the Netherlands in the last six months of the war, or a machine without camouflage paint that operated at RAF Wunstorf in West Germany in 1947.

The second kit in the Weekend edition in 1/48 scale is the Fw 190A-4. The technical configuration of the machines in this item's kit is interesting. This is the version equipped with flaps on the engine cooling exhaust and two cannons in the wing root. The decals traditionally offer four variants. Three are fighter-bomber variant machines. One served on the African theatre, another in France, including attacks on Great Britain, and the remaining two machines belonged to the Grunherz Geschwader on the Eastern Front. The fourth machine, which will also be shown in the box art, is a A-4 fighter piloted by Otto Kittel, the Luftwaffe's fourth most successful fighter pilot.

This reissue brings back to the range the long sought after ProfiPACK 1/72 scale kit of the two-seat UTI MiG-15. I hope it will make modelers happy and bring you good business.

BRASSIN

Most of the new products in the Brassin range have been produced by direct 3D printing for many months now, and April will be no different. It's good to know that sales of Brassin range printed kits continue to grow, so at the end of last year we installed two more 3D printers to better and more flexibly meet the growing demand.

For the premiere A6M2-N Rufe in 1/48 scale (Eduard) we are releasing simultaneously a whole range of accessories, based on the sets for A6M2 Type 21. Some publications state that the Rufe did not have folding wingtips. In fact, at least several dozen early production aircraft were equipped with folding wing tips. We also publish the popular LööK set for the Rufe, which

saves modelers time when painting parts and allows easy piece-for-piece replacement.

For the F4F-3 Wildcat in 1/48 scale we will release another set with an engine model, this time for a F4F-3 Late, differing from the earlier set for the F4F-3 Early by the engine cover with two versions of the front ring and some installations underneath.

The Messerschmitt Bf 110E (Eduard) kit in 1/72 scale returns with three sets with an updated design, released under new catalogue numbers. The wheelset is classically cast, as is usually the case with wheelsets. The nose gun set, on the other hand, is printed. The cockpit set is interesting, the base of which has remained cast, but the floor with the gun installation and the rear machine gun are printed. It must be added that these prints are exceptionally fine and detailed.

The 1/48 scale Avro Anson Mk.I kit from Airfix rightly attracts a lot of attention. We follow up the previous sets we have released for it with a quartet of machine guns in April.

For Kinetic's 1/48th scale F-16 kits, we are releasing two printed sets, a radar and an exhaust nozzle. In addition, we are releasing a LööK set for the Block 25 machines. In conjunction with the release of the Limited Edition Mi-24 Eduard kit (plastic parts by Zvezda), we are introducing a cockpit set in turquoise color. This is a follow-up to the black cockpit, which is part March releases. Both sets are being released in a new technological combination of 3D printing and SPACE 3D decal.

The new 1/32 scale Hawker Hurricane Mk.IIb from Revell has attracted a lot of attention. In April we are releasing two printed sets of exhausts and a set of cast landing gear wheels.

With April's new releases, we also return to Tamiya's 1/48 scale Skyraiders. We have prepared an ejection seat, testing modeler interest in seats with integrated seatbelts printed with the seat. It is expected that the modelers will paint these belts. The set does not include the otherwise usual pre-painted photo-etched STEELBELTS.

In the LööKplus range, the new releases include sets for the Bf 109G-4 in 1/32 scale (Revell), the Anson Mk.I (1/48, Airfix) and the P-39Q (1/72, Arma Hobby).

There will be two BigSin sets, an F-14D (1/48, Tamiya) and a weapons set for the Tornado IDS (1/32, Italeri).

Also with two 1/35 scale kits we continue with generic accessories for German WW2 AFVs, this time it will be a lever and wire cutters.

SPACE

We have five new products in the Space range. Where appropriate from a modelling point of view, we combine our 3D decals in the Space sets with photo etched parts. In 1/48 scale we will release sets for F4U-1D (Hobby Boss), A6M2b Zero (Academy), A6M2-N Rufe (Eduard) and in 1/72 scale we will release Space sets for U-2C (Hobby Boss) and UTI MiG-15 (Eduard).

Photo-etched parts

In April we continue with the 1/24 scale photo-etched sets for the Spitfire Mk.IXc from Airfix by adding two items to the pair of sets now released in the March collection.

For the A6M2b Zero in 1/48 scale from Academy, we are releasing a photo-etched landing flaps and a set for cockpit in two colours based on the cockpit colouring of the machines produced by Mitsubishi or Nakajima.

For the 1/48 scale B-24D kit by Revell (ex-Monogram) we are releasing another photo-etched set in April, this time focusing on the bomb bay. The original set is already sold out and we have modified this newly released design to current standards and practices.

The photo-etched sets on the Mi-8MT kit (1/48, Zvezda) are a follow-up to the Space and Mask sets released in March.

In April, we are finally bringing back the photo-etched sets for the 1/48 scale Hellcat (Eduard) versions F5F-3

and F6F-5. The set for Dash 5 is also in a partially upgraded designed.

The previously released set for F4U-1A (1/48, Hobby Boss) is followed by a modified set for Corsair version F4U-1D.

Similarly, the 1/72 set for the U-2A kit by the same manufacturer is the basis for the U-2C kit released in April. For the same month there is planned also a set for the F-14B Tomcat (Academy) in this scale, again based on the already released F-14A set.

For the new SdKfz 251/1 Ausf.C kit (1/35, Academy) we are releasing two sets. The first will also include the 3D SPACE decals with dashboard instruments and the second one will include the opening boxes on the sides of the halftrack. The other new 1/35th scale kit is Takom's M48A5. The set includes, among other things, functional opening crates on the tank's fenders.

Hobby Boss has released a 1/350 scale kit of the battleship USS Missouri (BB-63). In April we will release the first of a planned collection of photo-etched sets for this famous ship.

Orders

We would welcome your pre-orders for April items by Wednesday, March 1, 2023.

I would like to point out that due to the situation where there is a noticeable drop in sales especially for accessories, we are putting into production volumes consistently based on the total number of pre-orders for each item produced. The quantities that create a reserve for customers without pre-orders are significantly reduced in production and are largely produced only according to the requirements resulting from actual orders. Therefore, if you do not have pre-orders, your new orders may be delayed. This is a situation we have long warned against. In the boom times, this was rarely the case, but the current situation is different and forces us to rationalize our procedures. Thank you for your understanding and cooperation!

March items will be ready for shipping on Friday, 17 February.

From March 1, 2023, we will stop dispatching shipments for a period of ten days to two weeks due to the relocation of our warehouse to a new hall. Please expect delays in responding to your emails sent to Petra, department and other usual addresses during the same period. In case of an urgent problem, I recommend contacting me directly by phone, or to my e-mail address.

We expect to receive the last orders before the sales department closes on Friday, 24 February, and ship them on Monday, February 27. Therefore, it is important that we have your orders for March's new releases along with your stock as soon as possible in order to properly ship your orders. We will still inform you of the exact start and end date of the move in a separate email at the end of February.

In the past few days, we have expanded the list of items in **the Sweep sale to include Brassin series sets**. The bulk of these items are older cast sets, with lower sales over the past year. This sale is part of the ongoing renewal of the range. We will be replacing some of these sets with newly designed printed sets in the future. We will send you a list and price list of the items being sold off in a separate email tomorrow. They will again be discounted by 50% and their discount will not be combined with other discounts.

We are also sending folder with the graphics included in the Leaflet. Many of you are using our Leaflet images for pre-order section of your e-shops and in your newsletters. We hope this will save you some time. If you would like get more information, clarify some points or if you would need our help, please contact us at department@eduard.cz or contact me directly at jan.bobek@eduard.cz

Jan Bobek

Product previews are subject of change.

Instruction sheets,
more pictures and information
can be found on www.eduard.com

This leaflet can be downloaded from on www.eduard.com

eduard

PLASTIC KITS



82183 **Z-326/C-305 Trenér Master** 1/48 ProfiPACK

DETAIL



8209 **Bf 110C** 1/48 ProfiPACK

DETAIL

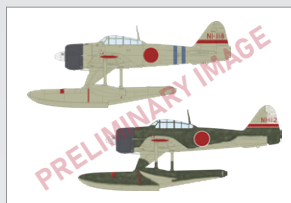

11171 **RUFÉ DUAL COMBO** 1/48 LIMITED

DETAIL



84117 **Fw 190A-4 w/engine flaps & 2-gun wings** 1/48 Weekend edition

DETAIL



84187 **Tempest Mk.V Series 2** 1/48 Weekend edition

DETAIL



7055 **UTI MiG-15** 1/72 ProfiPACK **Re-release**

DETAIL

MASKS

| | | |
|-------|-----------------------------------|-----------------|
| EX934 | A6M2-N Rufe TFace | 1/48 Eduard |
| EX935 | F4U-1D | 1/48 Hobby Boss |
| EX936 | F4U-1D TFace | 1/48 Hobby Boss |
| EX937 | A6M2b TFace | 1/48 Academy |
| EX938 | Mosquito B Mk.IV / PR Mk.IV TFace | 1/48 Tamiya |
| EX939 | Fw 190A-4 | 1/48 Eduard |
| CX645 | UTI MiG-15 | 1/72 Eduard |
| CX646 | U-2C | 1/72 Hobby Boss |
| CX647 | F-14B | 1/72 Academy |

SPACE

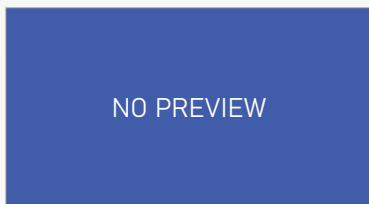

3DL48113 **F4U-1D SPACE** 1/48 Hobby Boss (2 parts)

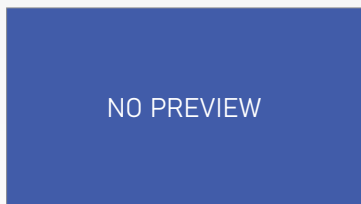

3DL48114 **A6M2-N Rufe SPACE** 1/48 Eduard (2 parts)

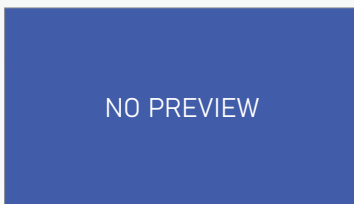

3DL48115 **A6M2b SPACE** 1/48 Academy (2 parts)

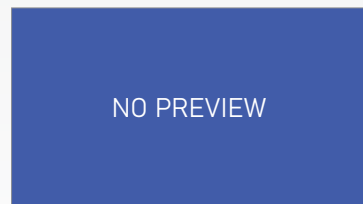

3DL72013 **U-2C SPACE** 1/72 Hobby Boss (2 parts)

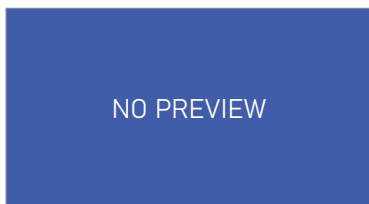

3DL72014 **UTI MiG-15 SPACE** 1/72 Eduard (2 parts)

PHOTO-ETCHED SETS

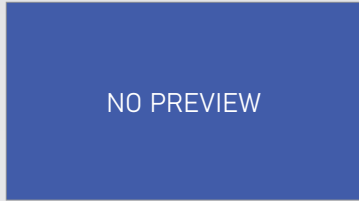

53292 USS Missouri BB-63
1/350 Hobby Boss
(1 part)

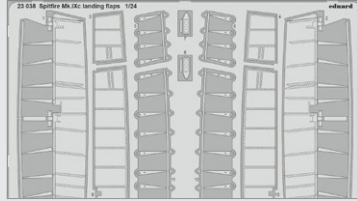

23038 Spitfire Mk.IXc landing flaps
1/24 Airfix
(1 part)

[DETAIL](#)

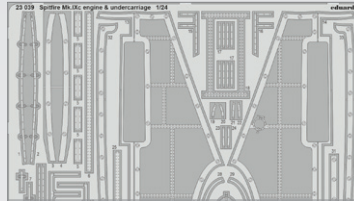

23039 Spitfire Mk.IXc engine &
undercarriage 1/24 Airfix
(1 part)

[DETAIL](#)

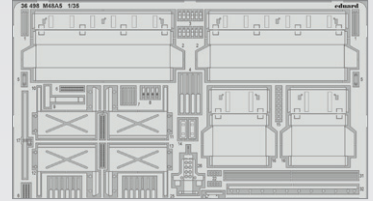

36498 M48A5
1/35 Takom
(1 part)

[DETAIL](#)



36499 Sd.Kfz. 251/1 Ausf.C
1/35 Academy
(2 parts)



36500 Sd.Kfz. 251/1 Ausf.C side
stowage bins 1/35 Academy
(1 part)

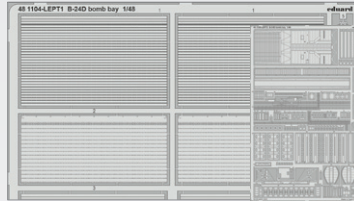

481104 B-24D bomb bay
1/48 Revell
(2 parts)

[DETAIL](#)

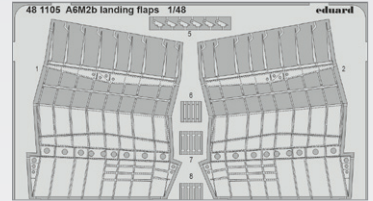

481105 A6M2b landing flaps
1/48 Academy
(1 part)

[DETAIL](#)

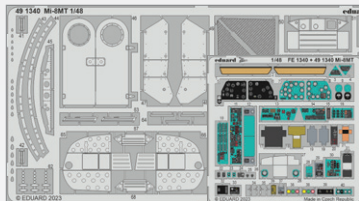

491340 Mi-8MT
1/48 Zvezda
(2 parts)

[DETAIL](#)

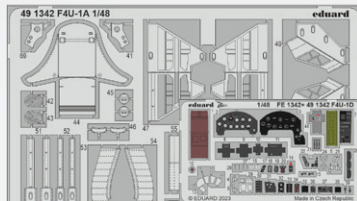

491342 F4U-1D
1/48 Hobby Boss
(2 parts)

[DETAIL](#)

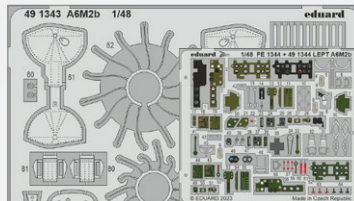

491344 A6M2b
1/48 Academy
(2 parts)

[DETAIL](#)

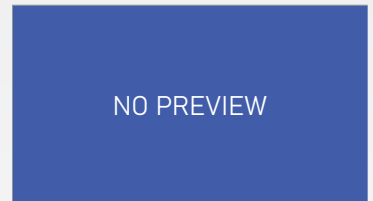

491346 F6F-3
1/48 Eduard
(2 parts)

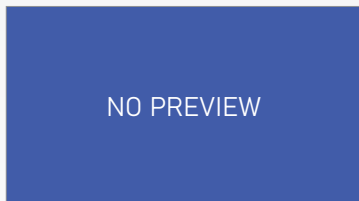

491347 F6F-5
1/48 Eduard
(2 parts)

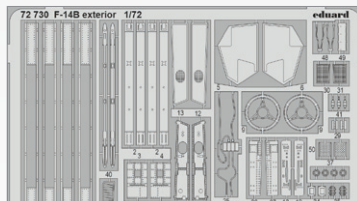

72730 F-14B exterior
1/72 Academy
(1 part)

[DETAIL](#)

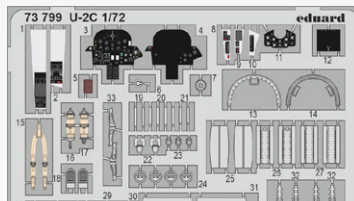

73799 U-2C
1/72 Hobby Boss
(1 part)

[DETAIL](#)

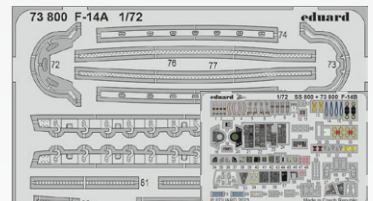

73800 F-14B
1/72 Academy
(2 parts)

[DETAIL](#)

PHOTO-ETCHED SETS

ZOOM

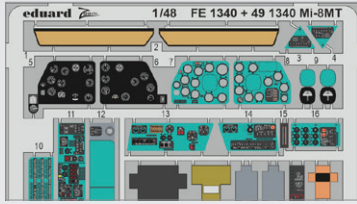

FE1340 Mi-8MT
1/48 Zvezda
(1 part)

DETAIL

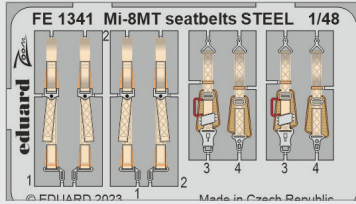

FE1341 Mi-8MT seatbelts STEEL
1/48 Zvezda
(1 part)

DETAIL

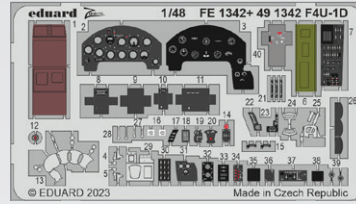

FE1342 F4U-1D
1/48 Hobby Boss
(1 part)

DETAIL

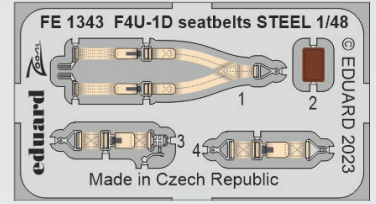

FE1343 F4U-1D seatbelts STEEL
1/48 Hobby Boss
(1 part)

DETAIL



FE1344 A6M2b
1/48 Academy
(1 part)

DETAIL

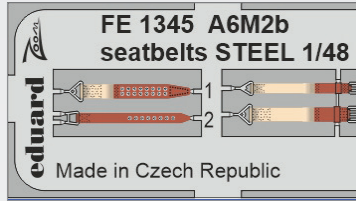

FE1345 A6M2b seatbelts STEEL
1/48 Academy
(1 part)

DETAIL

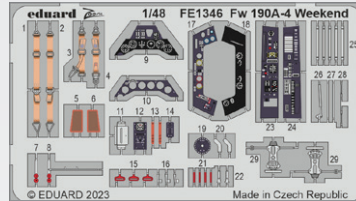

FE1346 Fw 190A-4 Weekend
1/48 Eduard
(1 part)

DETAIL

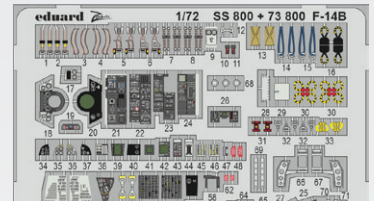

SS800 F-14B
1/72 Academy
(1 part)

DETAIL

BIG ED SETS

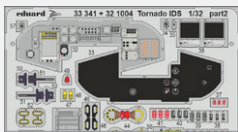

BIG33150 Tornado IDS
1/32 Italeri

DETAIL

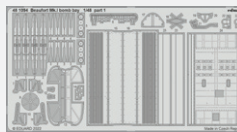

BIG49361 Beaufort Mk.I
PART II 1/48 ICM

DETAIL



BIG49362 A-10C
1/48 Hobby Boss

DETAIL

BRASSIN

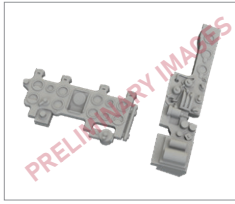

644205 A6M2-N Rufe **LööK**
1/48 Eduard

DETAIL



644206 B-25J **LööK**
1/48 HKM

DETAIL



644207 F-16C Block 25 **LööK**
1/48 Kinetic

DETAIL

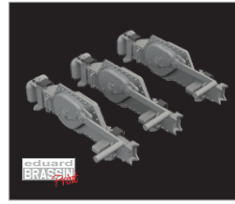

635024 WWII German 10 ton
jacks **PRINT** 1/35

DETAIL

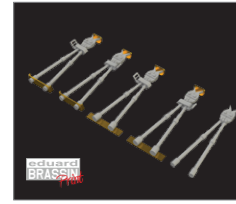

635026 WWII German wire
cutters **PRINT** 1/35

DETAIL

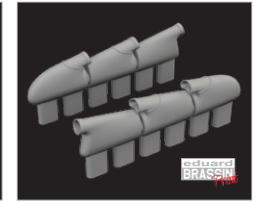

632188 Hurricane Mk.II
exhaust rounded **PRINT**
1/32 Revell

DETAIL

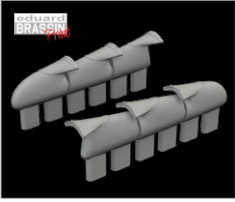

632189 Hurricane Mk.II
exhaust fishtail **PRINT**
1/32 Revell

DETAIL



632190 Hurricane Mk.II
wheels 1/32 Revell

DETAIL

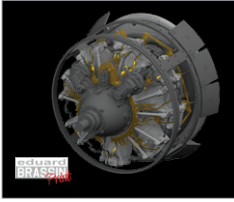

648826 F4F-3 engine late
PRINT 1/48 Eduard

DETAIL



648842 A-1J seat **PRINT**
1/48 Tamiya

DETAIL

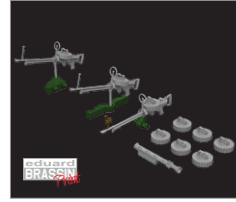

648844 Anson Mk.I guns
PRINT 1/48 Airfix

DETAIL



648845 A6M2-N Rufe seat
PRINT 1/48 Eduard

DETAIL

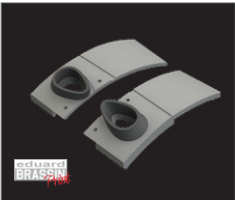

648846 A6M2-N Rufe ex-
haust **PRINT** 1/48 Eduard

DETAIL

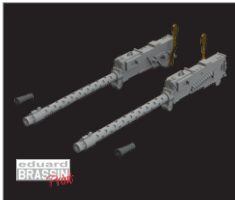

648847 A6M2-N Rufe
cannon barrels & cockpit
guns 1/48 Eduard

DETAIL

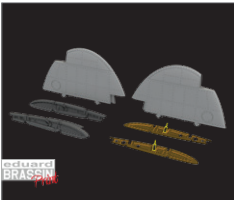

648848 A6M2-N Rufe folding
wingtips **PRINT** 1/48 Eduard

DETAIL

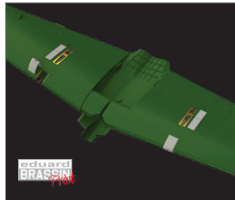

648849 A6M2-N Rufe gun
bays **PRINT** 1/48 Eduard

DETAIL

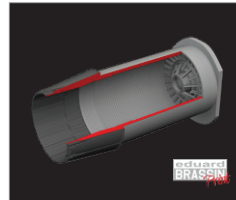

648854 F-16 exhaust
nozzle P&W F100 **PRINT**
1/48 Kinetic

DETAIL

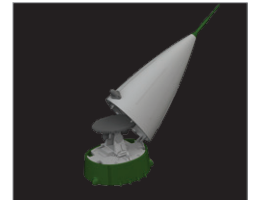

648855 F-16 radar early
PRINT 1/48 Kinetic

DETAIL

LööKplus

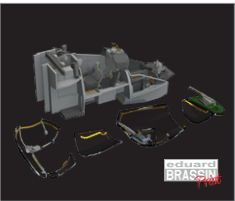

648857 Mi-24V cockpit
turquoise **PRINT & SPACE**
1/48 Eduard/Zvezda

DETAIL



672310 Bf 110E wheels
1/72 Eduard

DETAIL

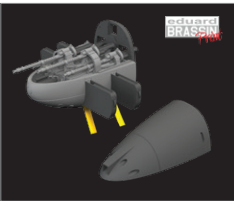

672311 Bf 110E nose guns
PRINT 1/72 Eduard

DETAIL

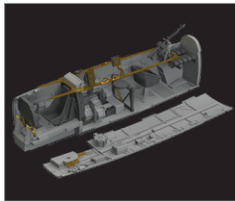

672312 Bf 110E cockpit
1/72 Eduard

DETAIL



634032 Bf 109G-4 **LööKplus**
1/32 Revell

DETAIL

LööKplus

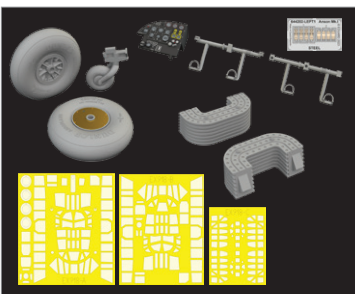

644204 Anson Mk.I **LööKplus**
1/48 Airfix

DETAIL

LööKplus



674003 P-39Q **LööKplus**
1/72 Arma Hobby

DETAIL

BIGSIN

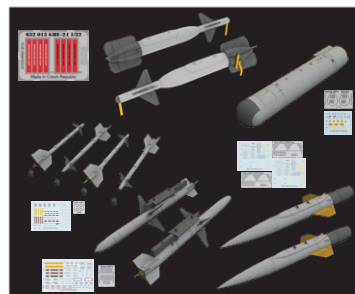

SIN63216 Tornado IDS armament
1/32 Italeri

DETAIL

BIGSIN

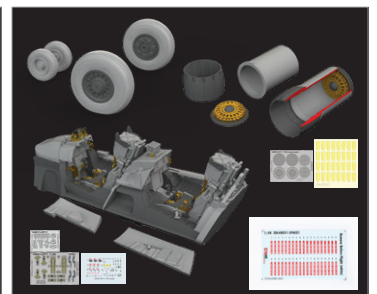

SIN648102 F-14D
1/48 Tamiya

DETAIL

ProfiPACK edition kit of Czechoslovak single engine two-seat trainer and aerobatic aircraft Zlin Z-326 Trenér Master including C-305, Z-326M and Z-326MF versions in 1/48 scale. Kit presents markings selection including Czechoslovak, Czech and foreign users.

BASIC INFO:

NAME: **Z-326/C-305 Trenér Master**

CAT. NO.: 82183

SCALE: 1/48

EDITION: ProfiPACK

CONTENTS:

SPRUES: Eduard

PE-SETS: Yes, pre-painted

PAINTING MASK: Yes

MARKING OPTIONS: 6

BRASSIN: No

RELATED PRODUCTS:

644186 Z-326 LööK (Brassin)

644197 Z-326 LööKplus (Brassin)

648729 Z-326/526 wheels (Brassin)

3DL48096 Z-326 SPACE (3D Decal Set)

D48097 Z-126/226/326/526 cockpit placards (Decal Set)

EX912 Z-326 TFace (Mask)

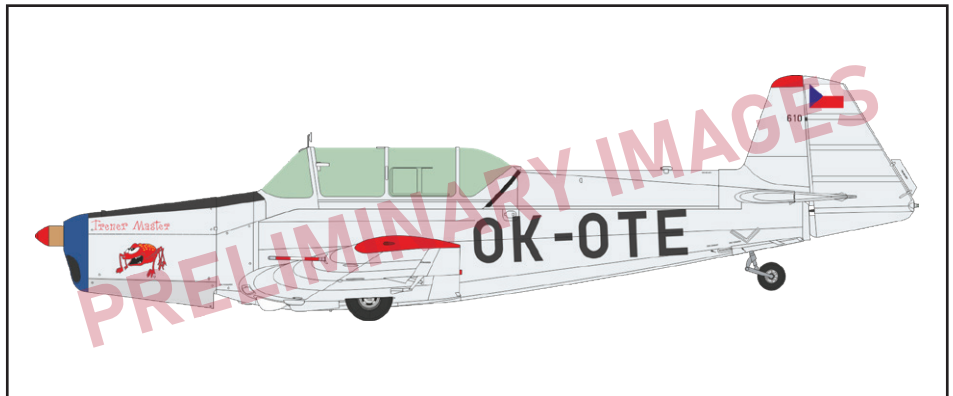

KIT PARTS

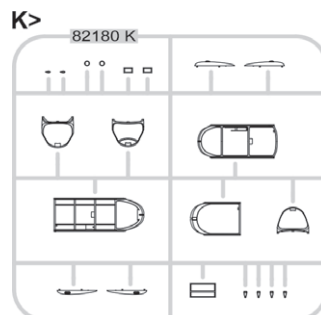
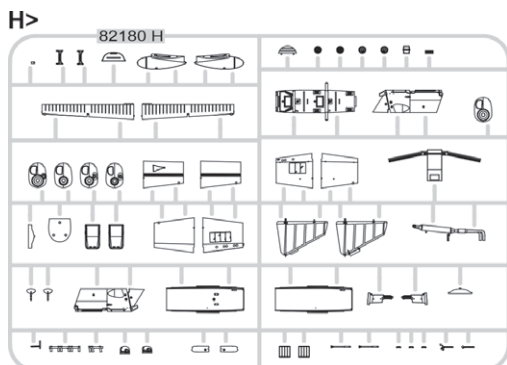
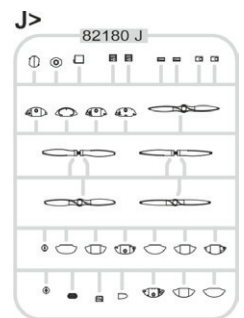
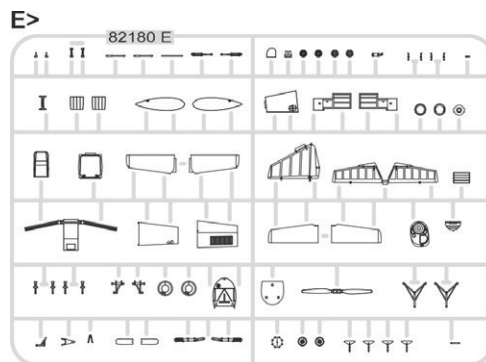
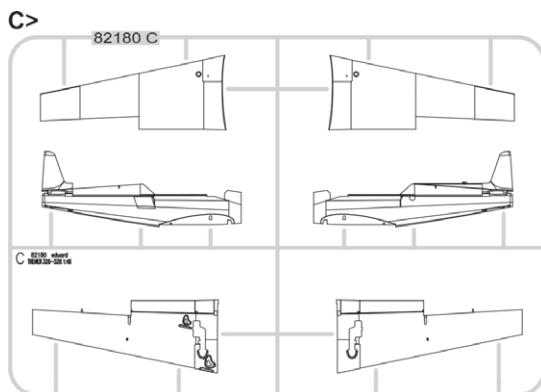

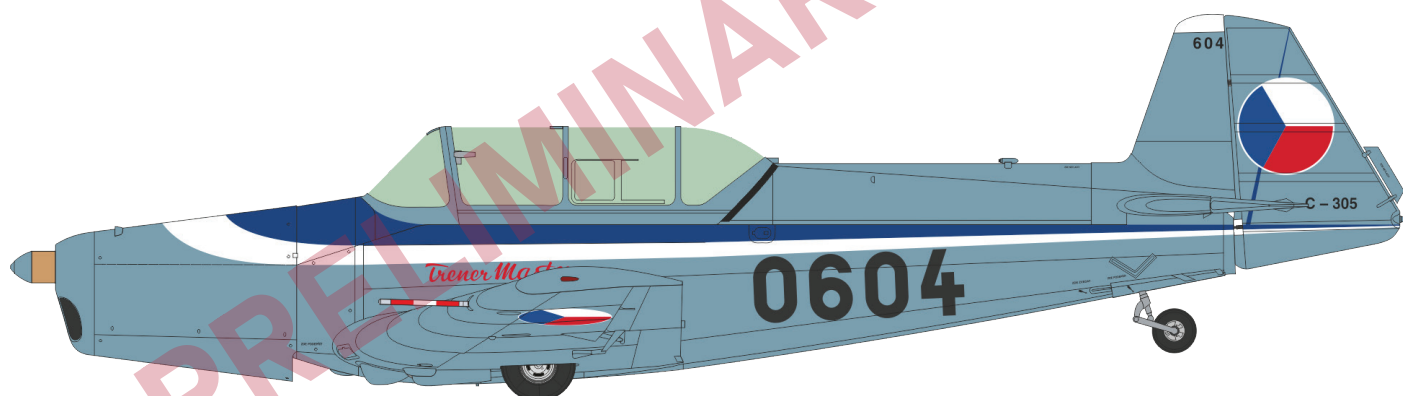
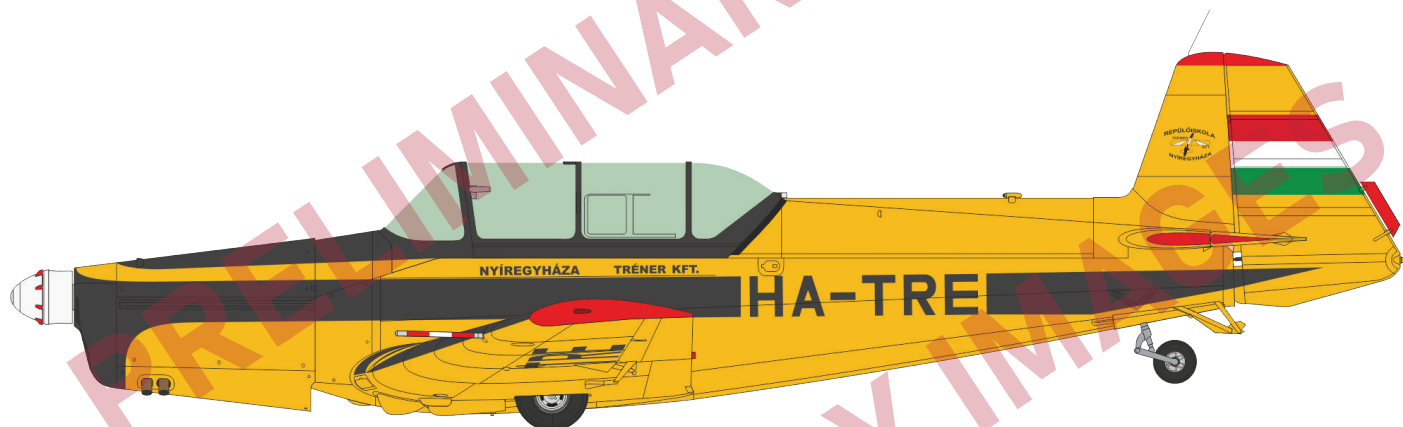
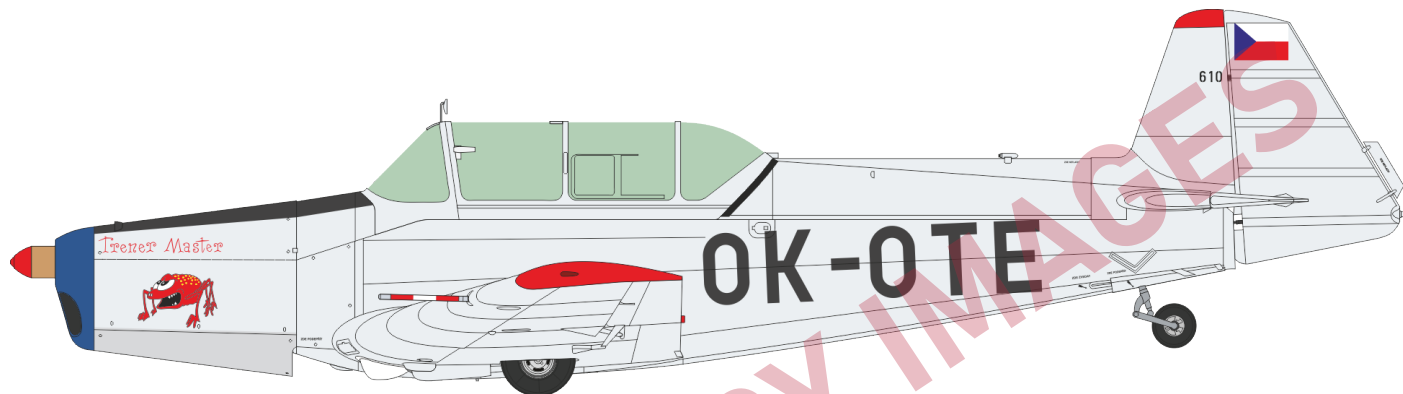

+ three more marking options

ProfiPACK edition kit of German WWII twin-engine heavy fighter aircraft Messerschmitt Bf 110C in 1/48 scale. This version was used as a day and night fighter.

BASIC INFO:

NAME: **Bf 110C**

CAT. NO.: 8209

SCALE: 1/48

EDITION: ProfiPACK

CONTENTS:

SPRUES: Eduard

PE-SETS: Yes, pre-painted

PAINTING MASK: Yes

MARKING OPTIONS: 5

BRASSIN: No

RELATED PRODUCTS:

644076 Bf 110C LööK (Brassin)

648085 MG 15 gun (2 pcs) (Brassin)

648602 Bf 110C/D radio equipment (Brassin)

648607 Bf 110C/D/E exhaust stacks (Brassin)

EX752 Bf 110C TFace (Mask)

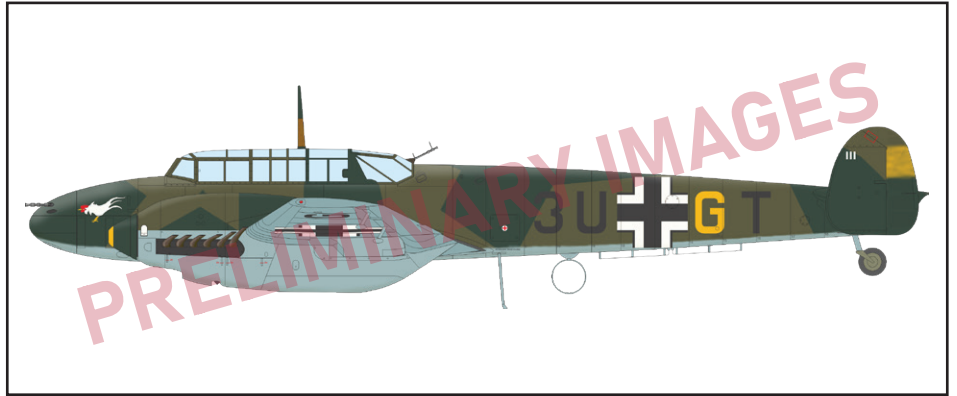

KIT PARTS

A>

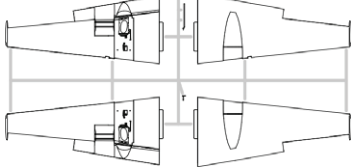

B>

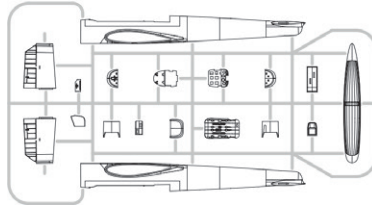

C>

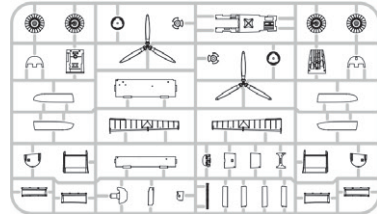

G>



H>

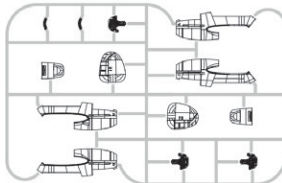

J>

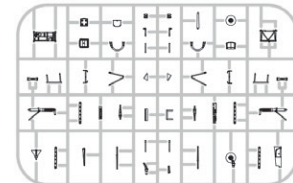

T>



U>

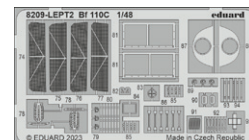
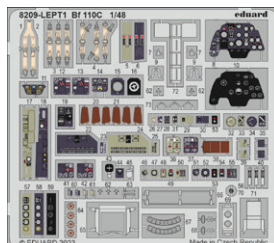

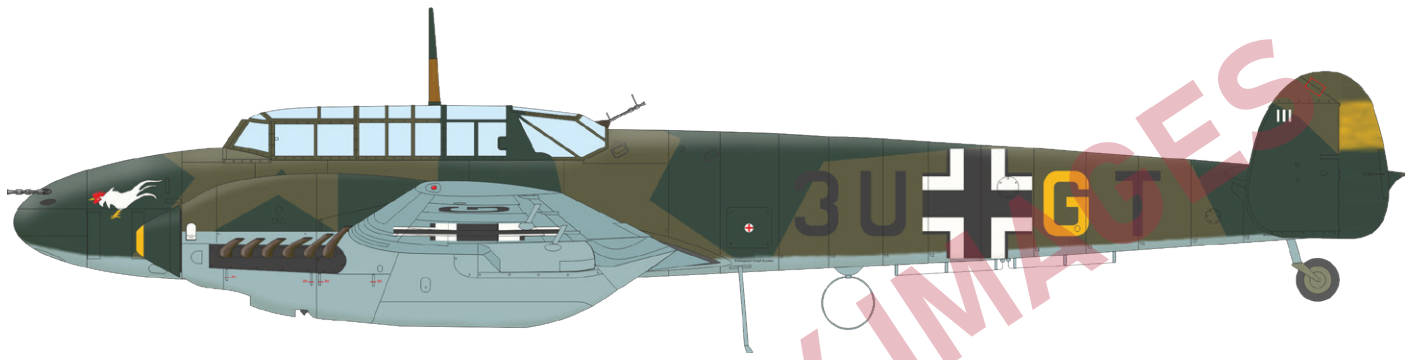

WNR. 3578, 9./ZG 26, Barly, France, August 1940

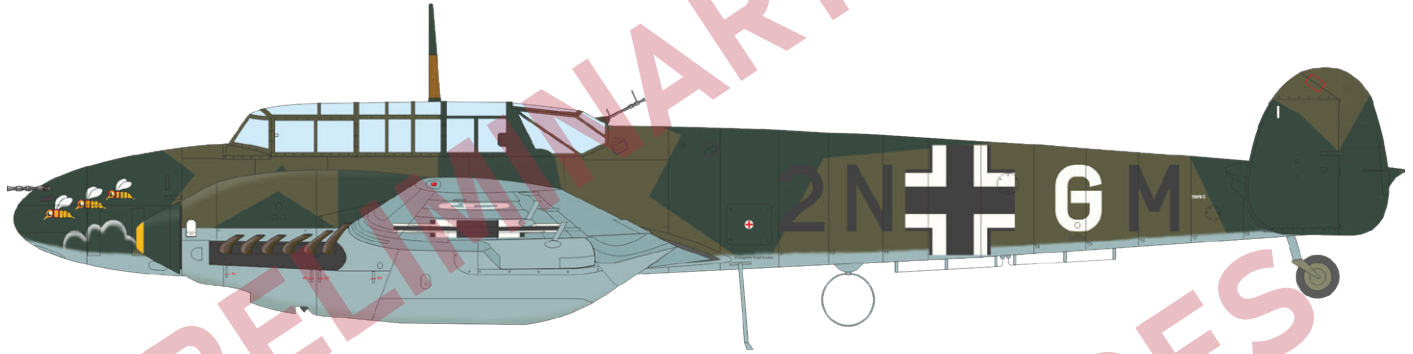

WNR. 2095, 4./ZG 1, Trier-Euren, Germany, June 1940



Hptm. Heinz Wagner / Stfw. Adolf Schmidt, 4./ZG 76, Abbeville, France, August 1940



1./NJG 3, Benghazi, Lybia, May 1941

+ one more marking option

WNR. 3026, Lt. K. Koch, 1.(Z)/JG 77, Kirkenes, Norway, October 1941

Limited edition kit of Japanese interceptor/fighter bomber floatplane A6M2-N (Allied code name Rufe) in 1/48 scale. Kit presents Rufe serving in Imperial Japanese Naval Air Force during World War II.

DUAL COMBO

BASIC INFO:

NAME: **RUFE DUAL COMBO**

CAT. NO.: 11171

SCALE: 1/48

EDITION: LIMITED

CONTENTS:

SPRUES: Eduard

PE-SETS: Yes, pre-painted

PAINTING MASK: Yes

MARKING OPTIONS: 8

BRASSIN: No

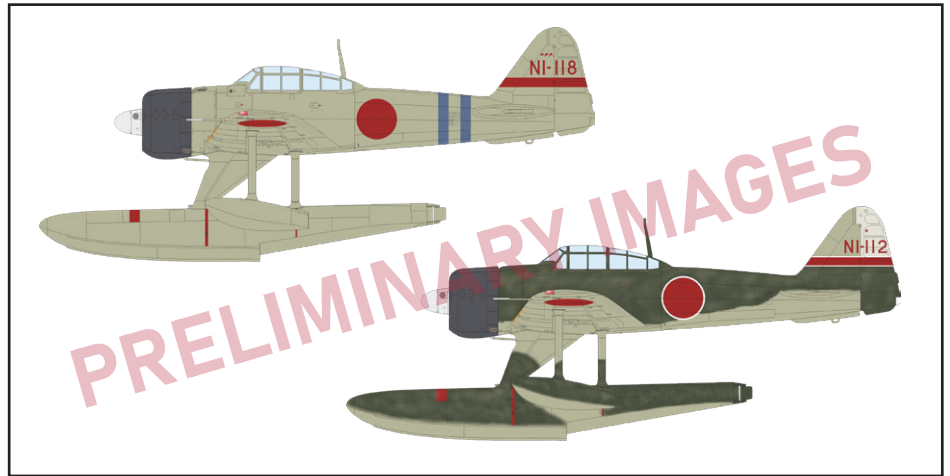

RELATED PRODUCTS:

644205 A6M2-N Rufe LööK (Brassin)

648845 A6M2-N Rufe seat PRINT (Brassin)

648846 A6M2-N Rufe exhaust PRINT (Brassin)

648847 A6M2-N Rufe cannon barrels & cockpit guns PRINT (Brassin)

648848 A6M2-N Rufe folding wingtips PRINT (Brassin)

648849 A6M2-N Rufe gun bays PRINT (Brassin)

3DL48114 A6M2-N Rufe SPACE (3D Decal Set)

EX934 A6M2-N Rufe TFace (Mask)

KIT PARTS

A 2x

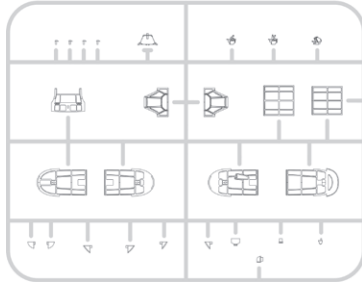

D 2x

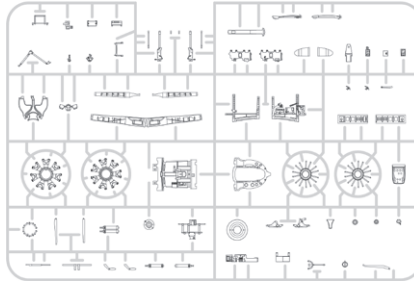

G 2x

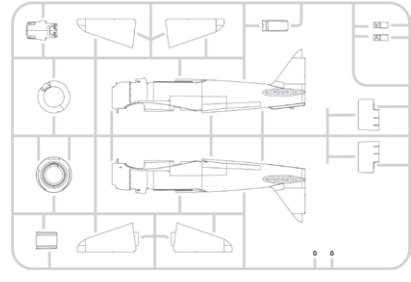

L 2x

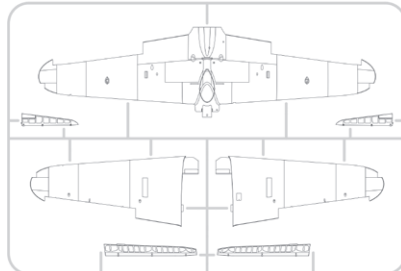

T 2x

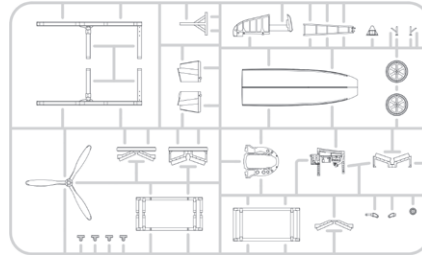

U 2x

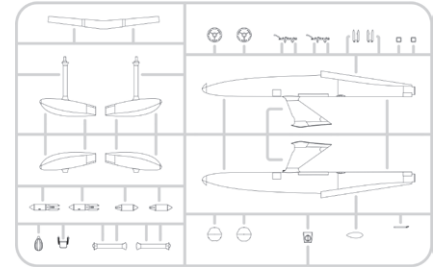

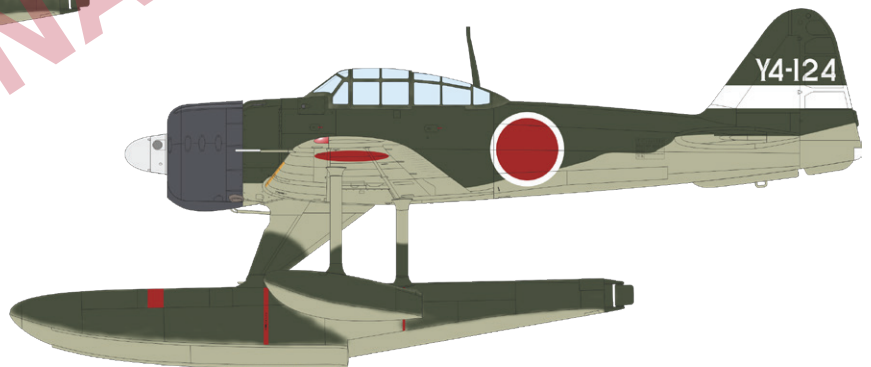
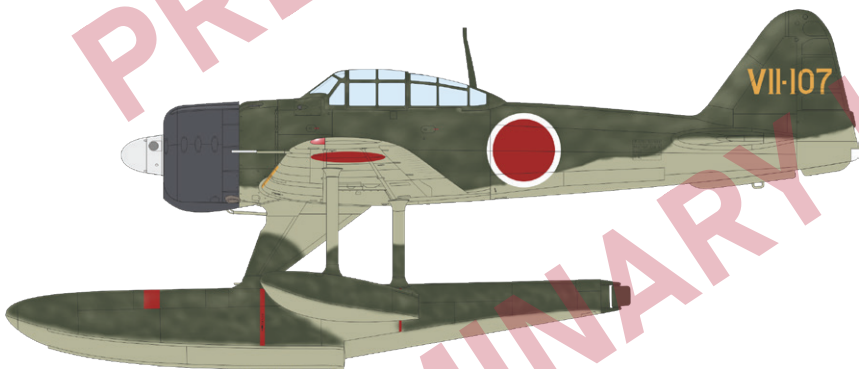
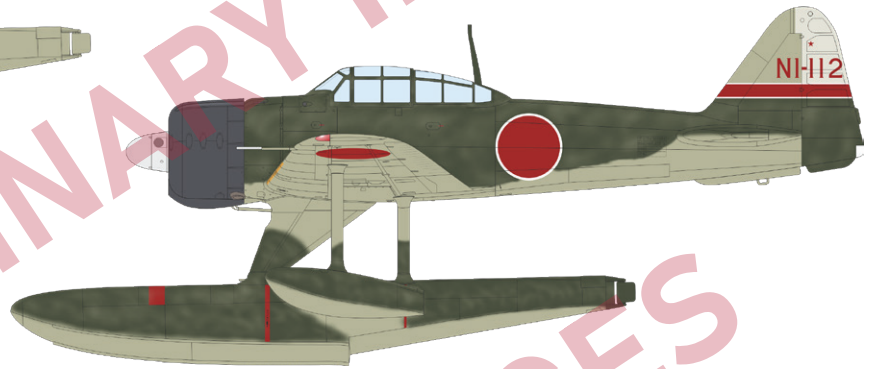
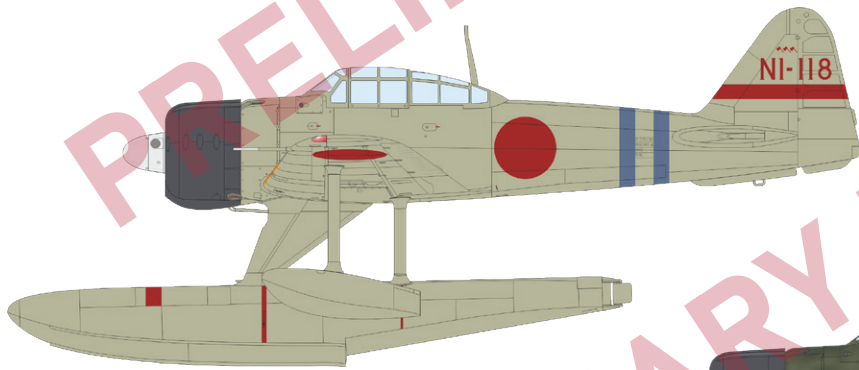
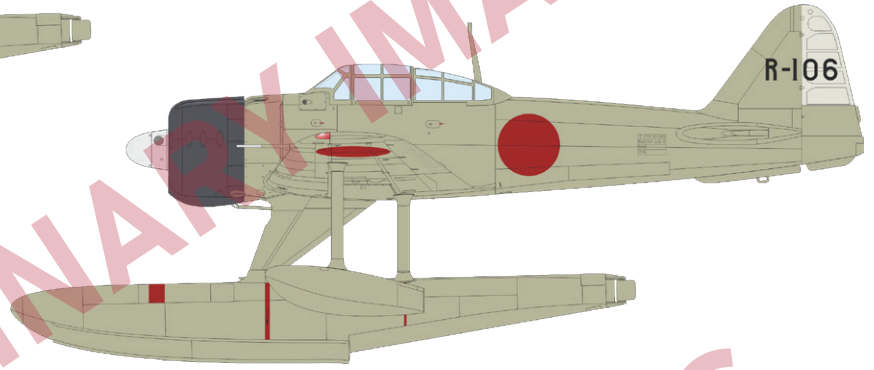
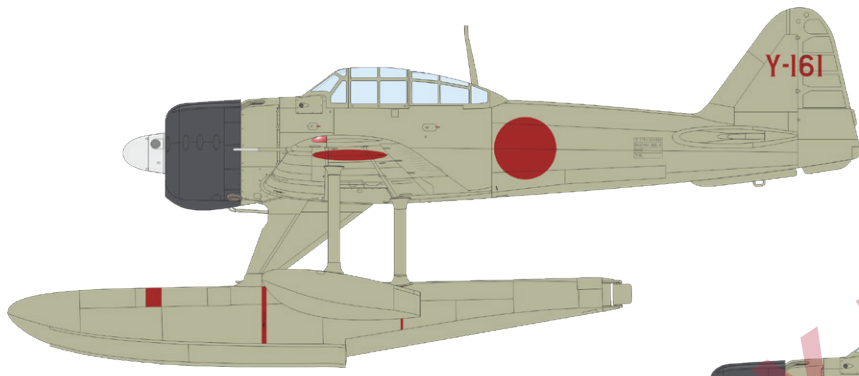

+ two more marking options

Weekend edition kit of German WWII fighter aircraft Fw 190A-4 in 1/48 scale. This version of the Fw 190A-4 was equipped with flaps on the engine cooling outlets. The wing was equipped with two cannons in the wing root.

BASIC INFO:

NAME: **Fw 190A-4 w/engine flaps & 2gun wings**

CAT. NO.: 84117

SCALE: 1/48

EDITION: Weekend edition

CONTENTS:

SPRUES: Eduard

PE-SETS: No

PAINTING MASK: No

MARKING OPTIONS: 4

BRASSIN: No

RELATED PRODUCTS:

48936 Fw 190A-4 landing flaps (PE-Set)

FE863 Fw 190A seatbelts STEEL (PE-Set)

648351 Fw 190A-4 cockpit (Brassin)

648352 Fw 190A-4 engine (Brassin)

648354 Fw 190A-4 fuselage guns (Brassin)

648356 Fw 190A wingroot gun bays (Brassin)

648366 Fw 190A propeller (Brassin)

648371 Fw 190A control surfaces early (Brassin)

648381 Fw 190A exhaust stacks (Brassin)

648778 Luftwaffe rudder pedals PRINT (Brassin)

SIN64837 Fw 190A-4 advanced (Brassin)

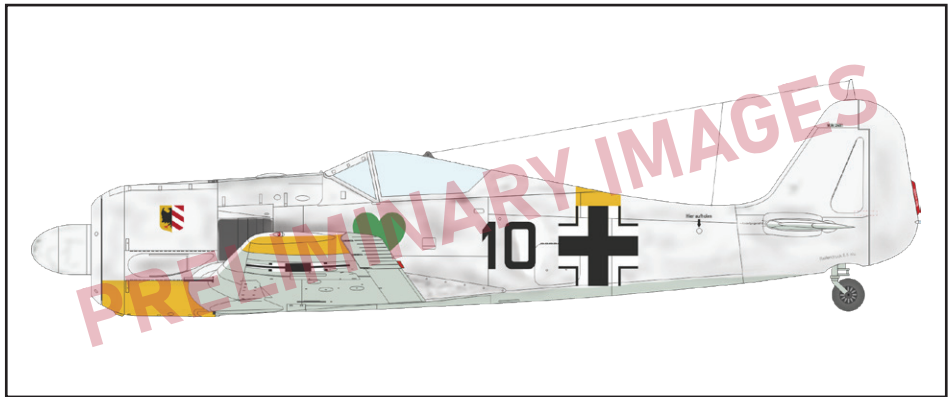

SIN64839 Fw 190A-4 essential (Brassin)

D48038 Fw 190A-4 national insignia (Decal Set)

EX587 Fw 190A TFace (Mask)

KIT PARTS

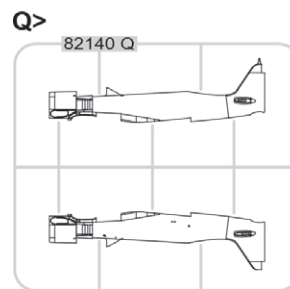
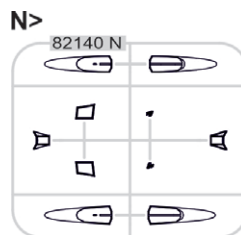
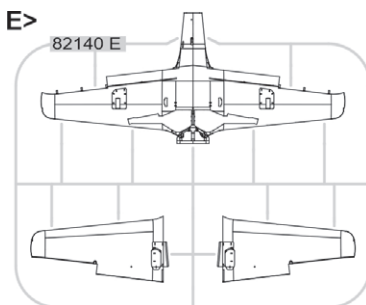
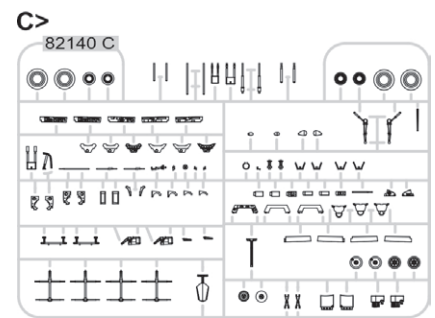
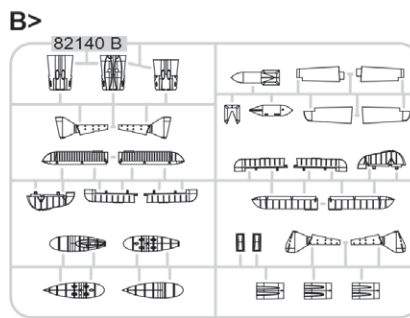
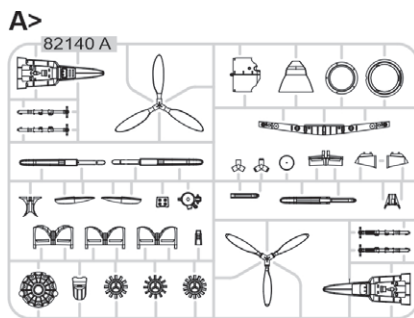

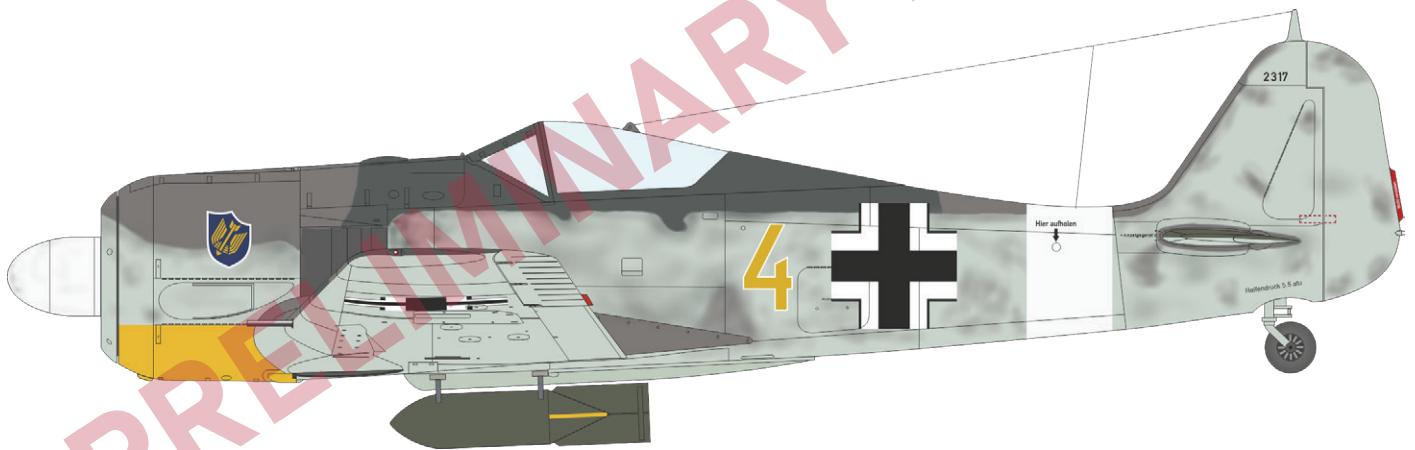
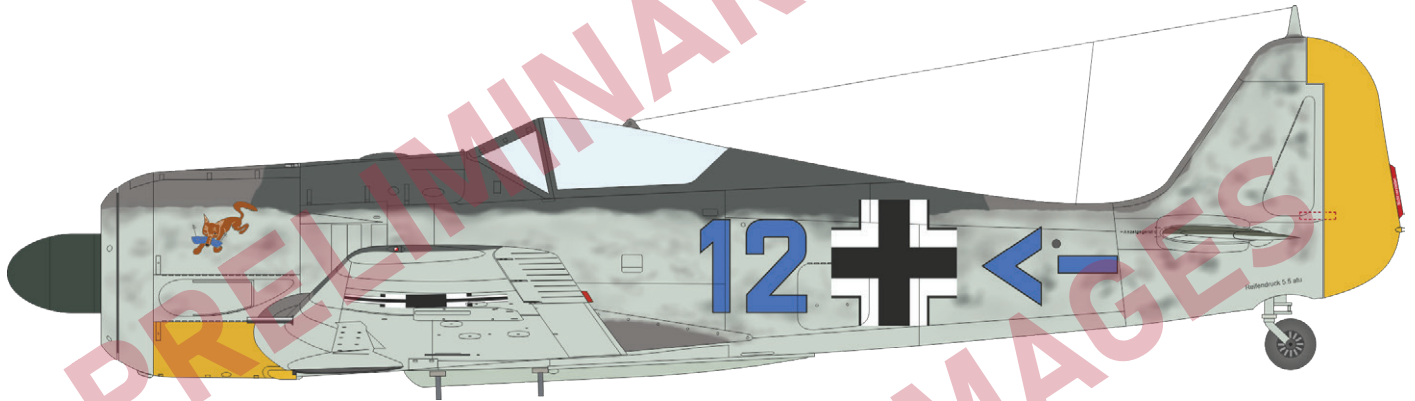
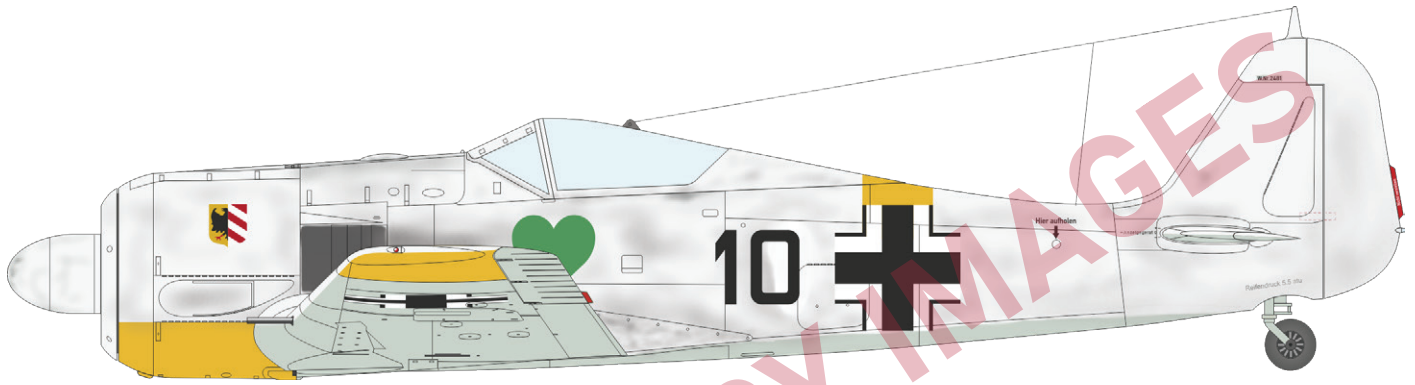

+ one more marking option

Weekend edition kit of British WWII fighter aircraft Tempest Mk.V in 1/48 scale. The kit offers the aircraft manufactured within Series 2 and serving in the RAF during and after the end of World War II.

BASIC INFO:

NAME: **Tempest Mk.V Series 2**

CAT. NO.: 84187

SCALE: 1/48

EDITION: Weekend edition

CONTENTS:

SPRUES: Eduard

PE-SETS: No

PAINTING MASK: No

MARKING OPTIONS: 4

BRASSIN: No

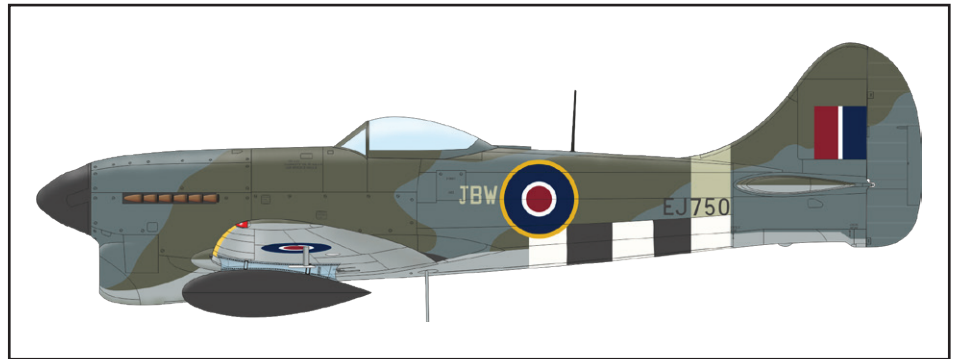

RELATED PRODUCTS:

48976 Tempest Mk.V upgrade set (PE-Set)

48977 Tempest Mk.V landing flaps (PE-Set)

FE943 Tempest Mk.V seatbelts STEEL (PE-Set)

FE1079 Tempest Mk.V series 2 Weekend (PE-Set)

BIG49212 Tempest Mk.V (PE-Set)

644006 Tempest Mk.V LööK (Brassin)

644039 Tempest Mk.V w/ late wheels LööKplus (Brassin)

648416 Tempest Mk.V cockpit (Brassin)

648417 Tempest Mk.V engine (Brassin)

648418 Tempest Mk.V exhaust stacks (Brassin)

648419 Tempest Mk.V gun bays (Brassin)

648421 Tempest Mk.V wheels late (Brassin)

648446 Tempest Mk.V undercarriage legs BRONZE (Brassin)

648450 RP-3 60lb rockets for Tempest Mk.V (Brassin)

648499 Tempest Mk.V intake ring (Brassin)

648500 Tempest Mk.V dust filter w/ eyelid (Brassin)

SIN64858 Tempest Mk.V ADVANCED (Brassin)

3DL48023 Tempest Mk.V SPACE (3D Decal Set)

D48030 Tempest Mk.V stencils (Decal Set)

EX628 Tempest Mk.V TFace (Mask)

EX695 Tempest Mk.V (Mask)

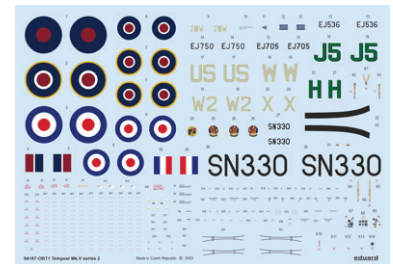

KIT PARTS

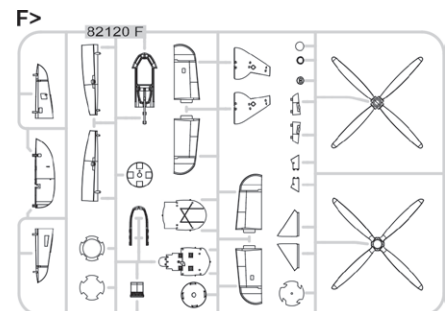
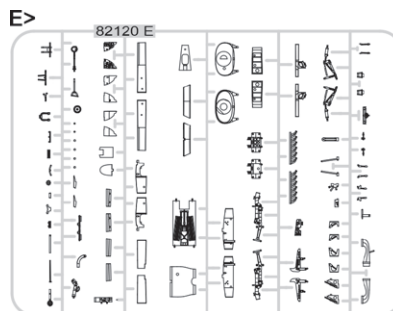
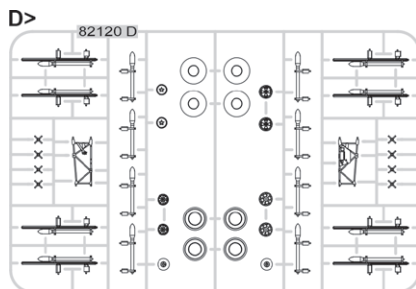
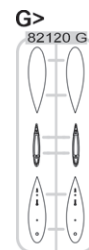
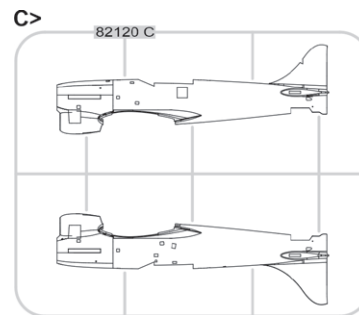
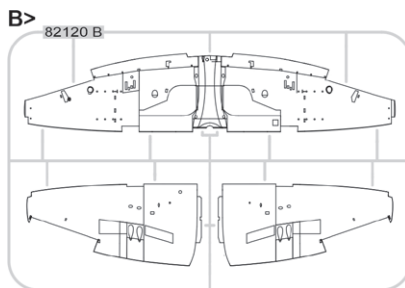

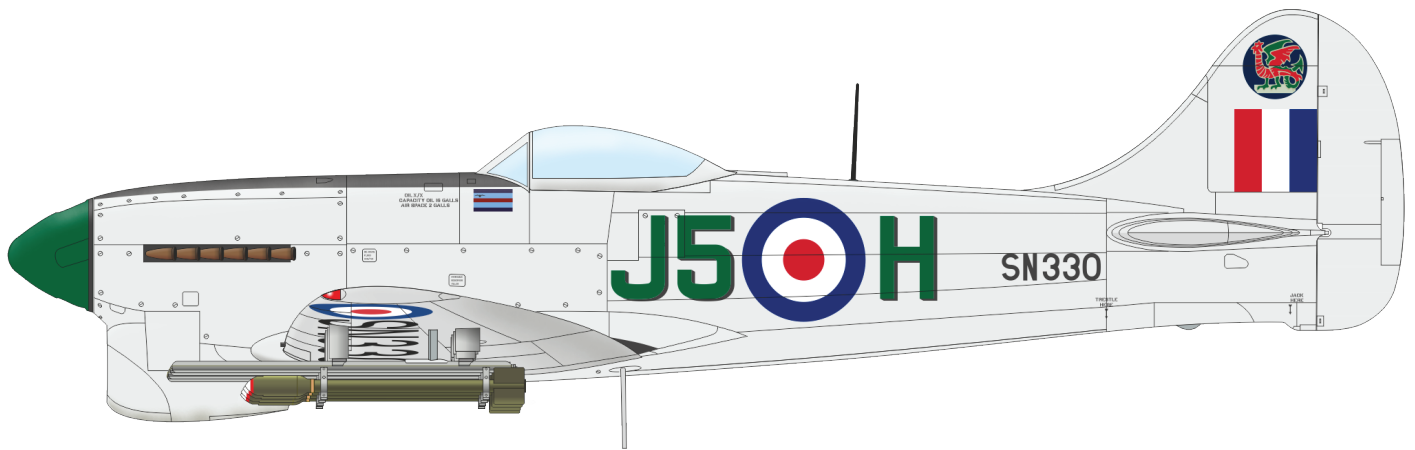
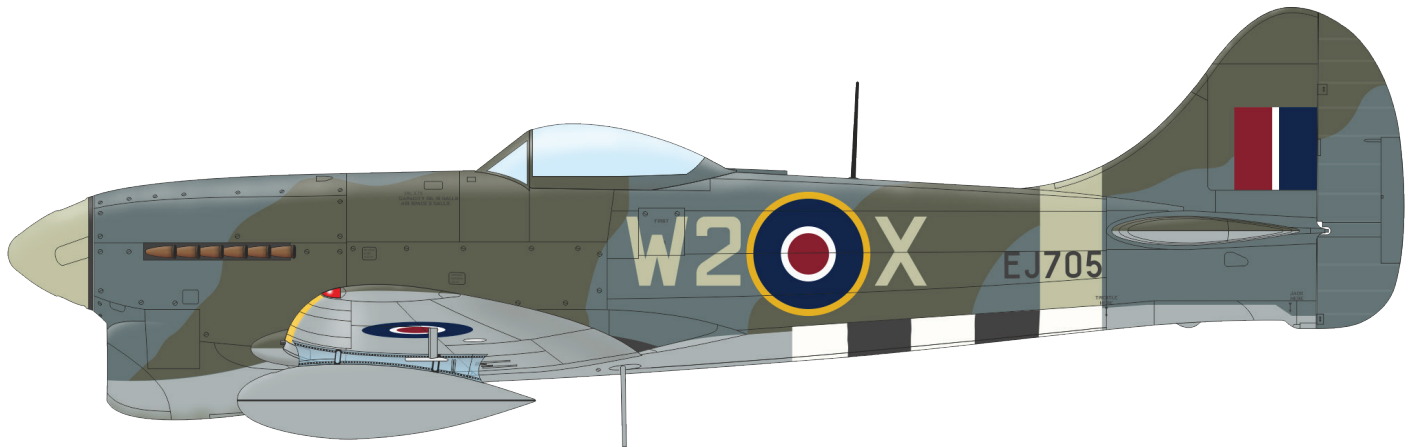
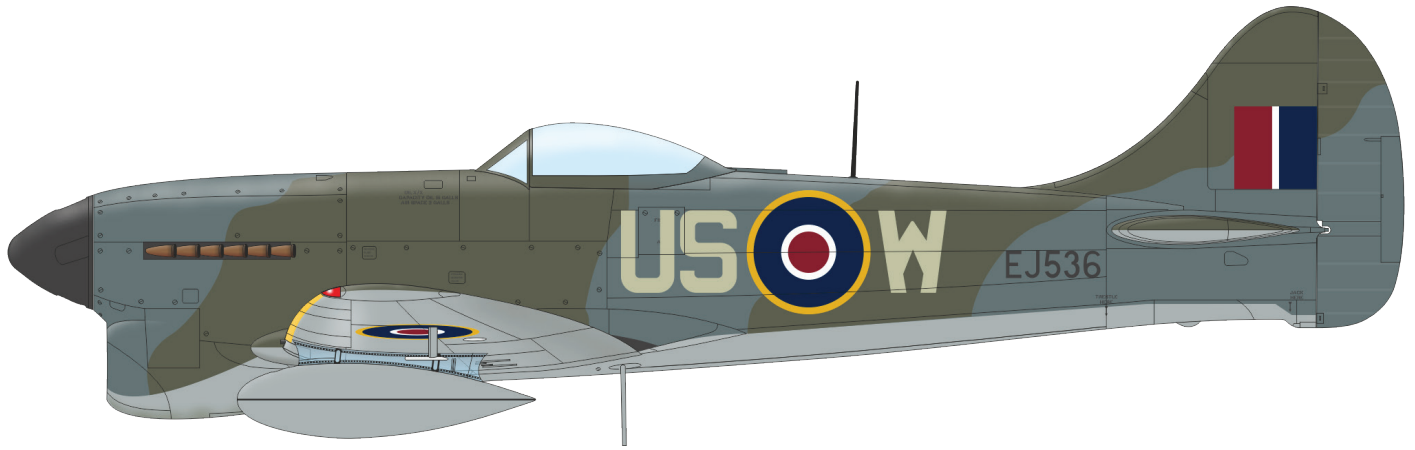
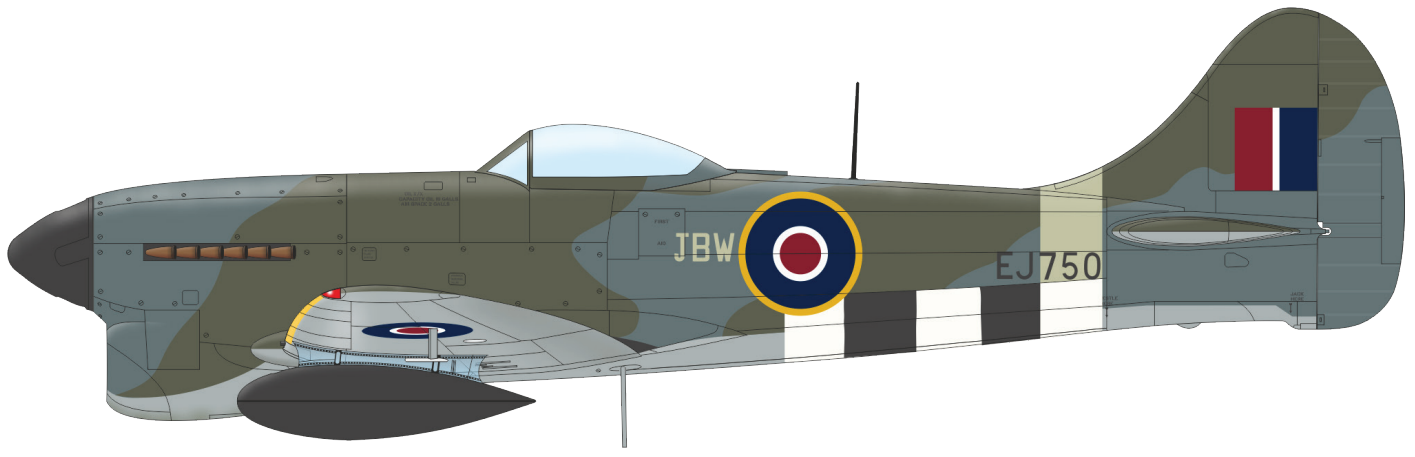

ProfiPACK edition kit of Soviet two-seat jet trainer aircraft UTI MiG-15 in 1/72 scale.

Re-release

BASIC INFO:

NAME: **UTI MiG-15 Re-release**

CAT. NO.: 7055

SCALE: 1/72

EDITION: ProfiPACK

CONTENTS:

SPRUES: Eduard

PE-SETS: Yes, pre-painted

PAINTING MASK: Yes

MARKING OPTIONS: 5

BRASSIN: No

RELATED PRODUCTS:

672077 UTI MiG-15 cockpit (Brassin)

3DL72014 UTI MiG-15 SPACE (3D Decal Set)

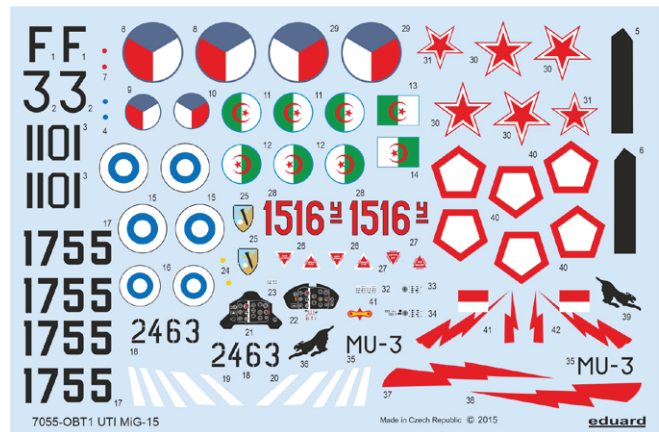

KIT PARTS

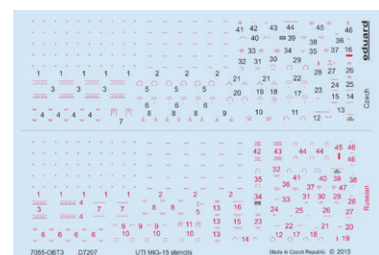
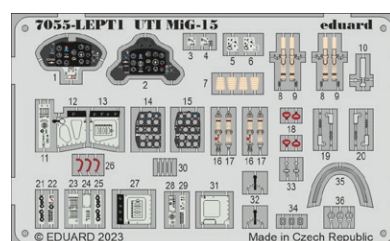
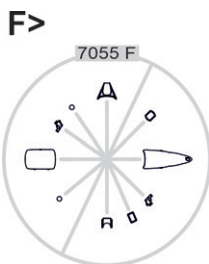
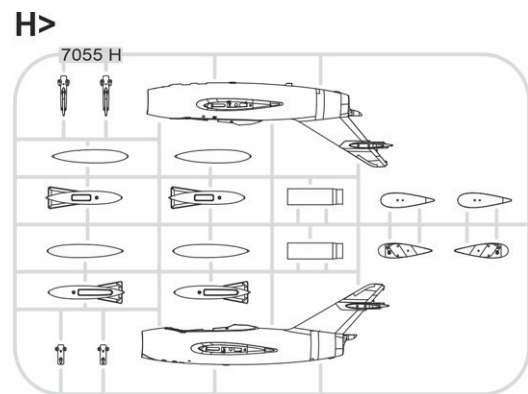
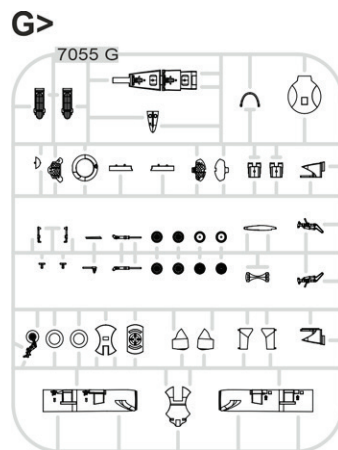
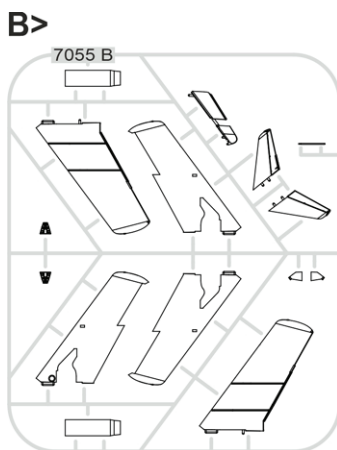

UTI MiG-15, 6th Fighter-Bomber Air Regiment, Přerov Air Base, Czechoslovakia, Summer, 1974

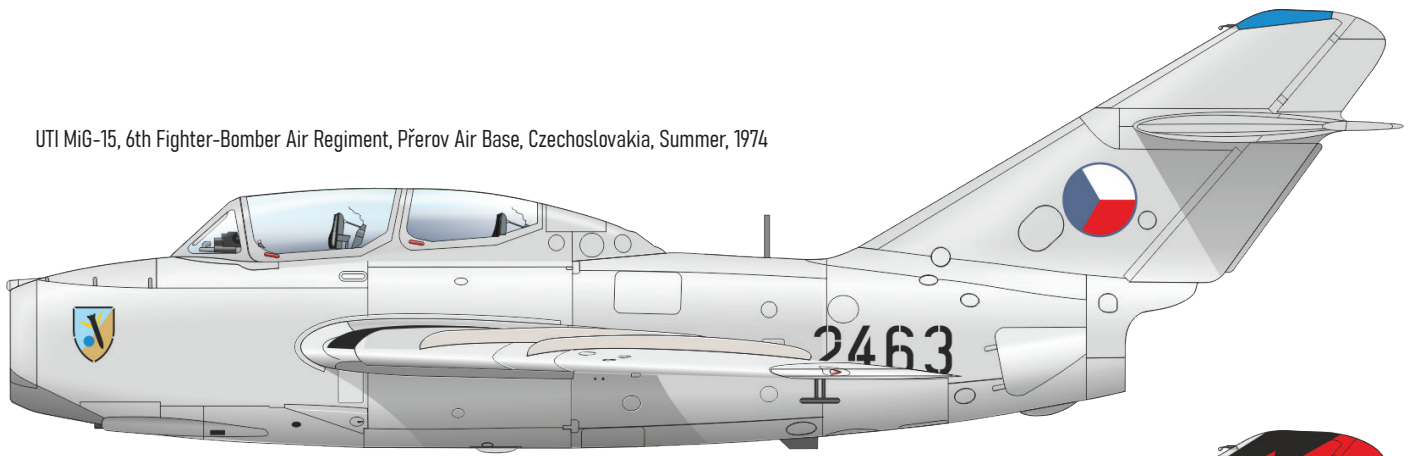

UTI MiG-15, Indonesian Air Force, Jakarta-Kemajoran Air Base, Indonesia 1960s



UTI MiG-15, Soviet Union, 1960s through the 1970s

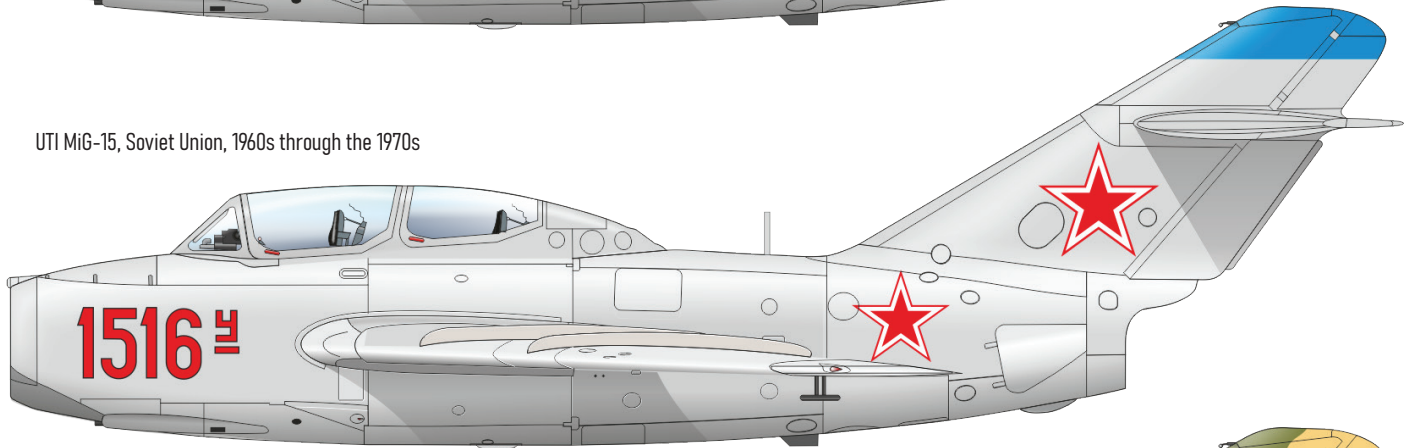

UTI MiG-15, Algerian Air Force, Algeria 1960s through the 1980s

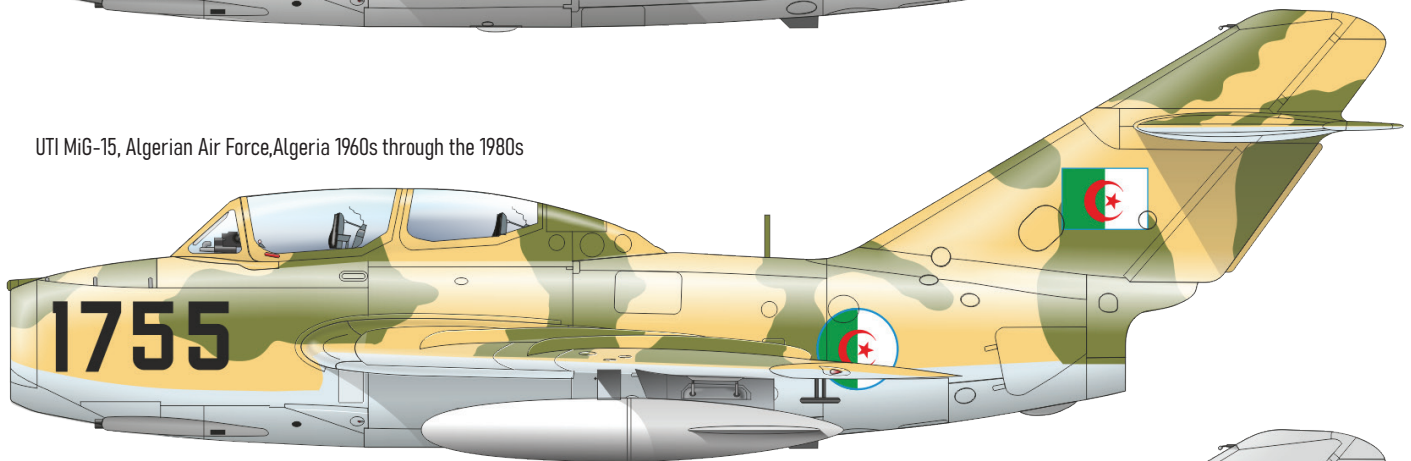

UTI MiG-15, c/n 922226, Hävittäjälentolaivue 31, Rissala Air Base, Finland, Late 1960s

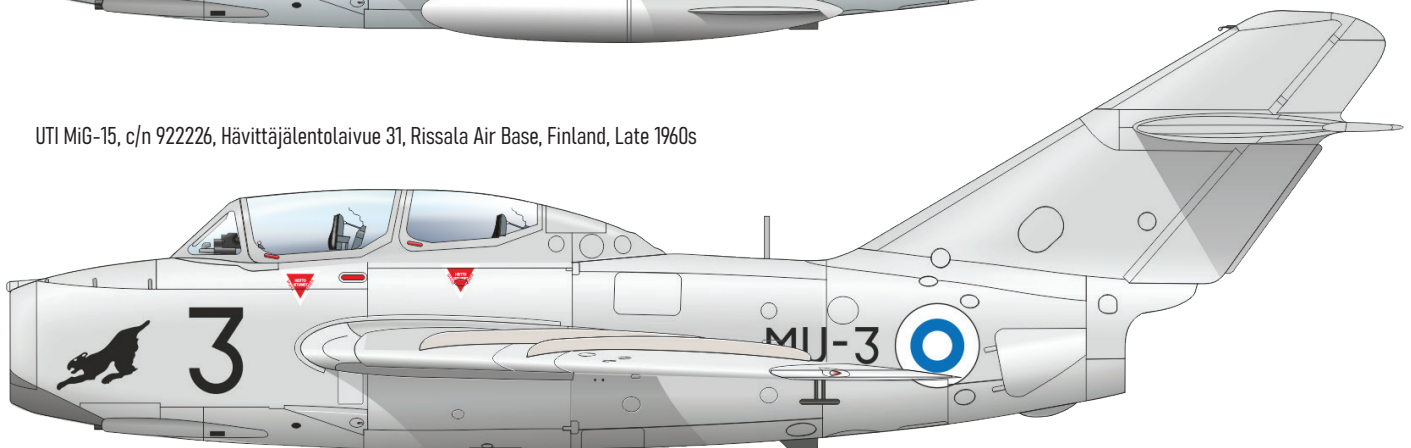

23038 Spitfire Mk.IXc landing flaps
1/24 Airfix

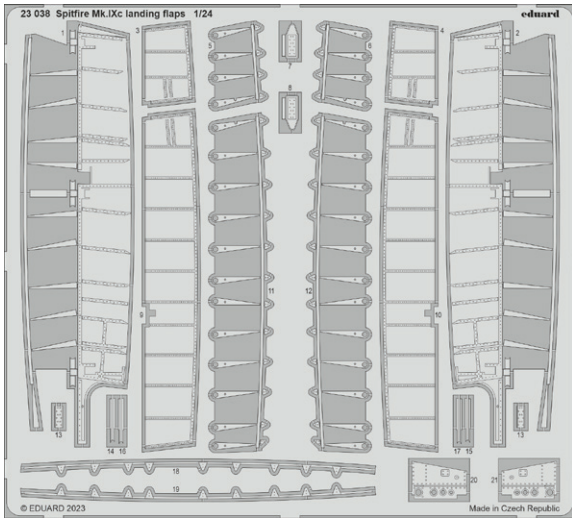

23039 Spitfire Mk.IXc engine & undercarriage
1/24 Airfix

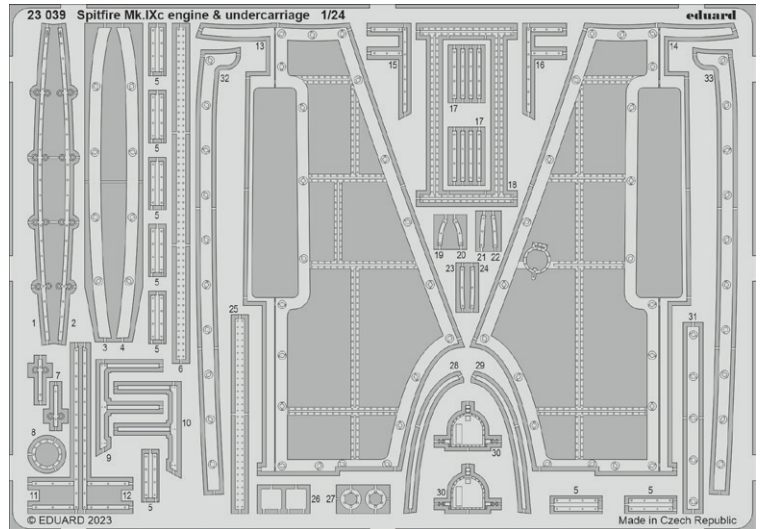

36498 M48A5
1/35 Takom

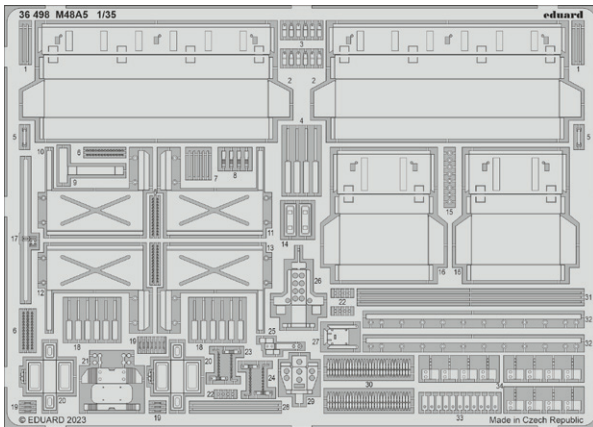

481104 B-24D bomb bay
1/48 Revell

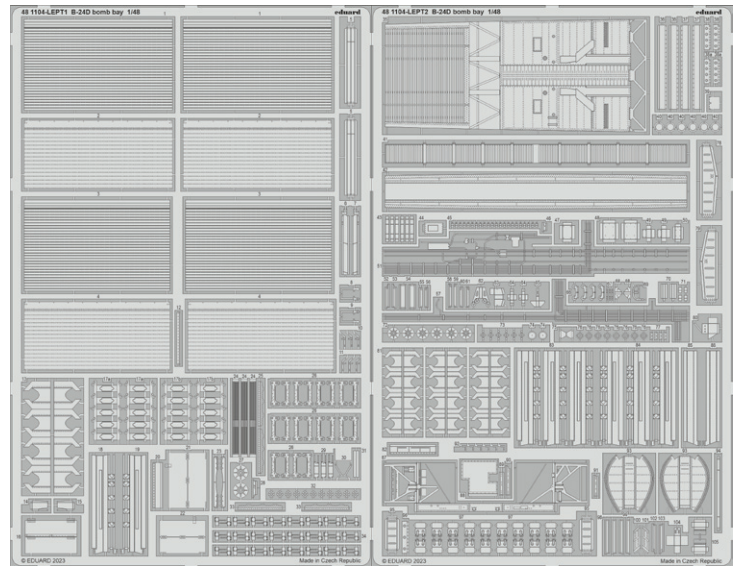

481105 A6M2b landing flaps
1/48 Academy

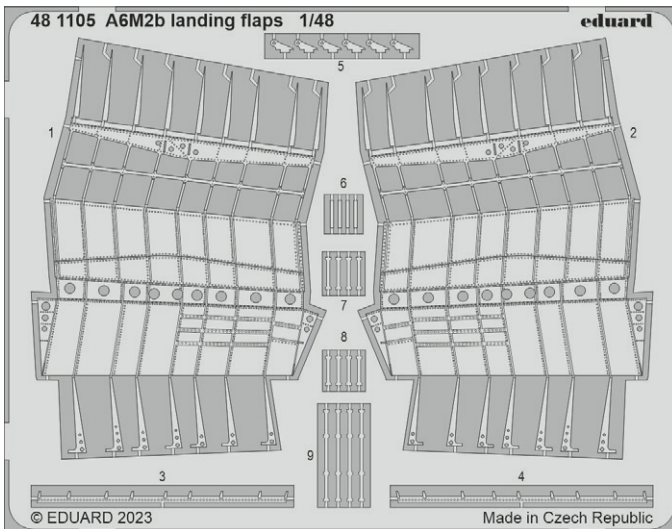

491340 Mi-8MT
1/48 Zvezda

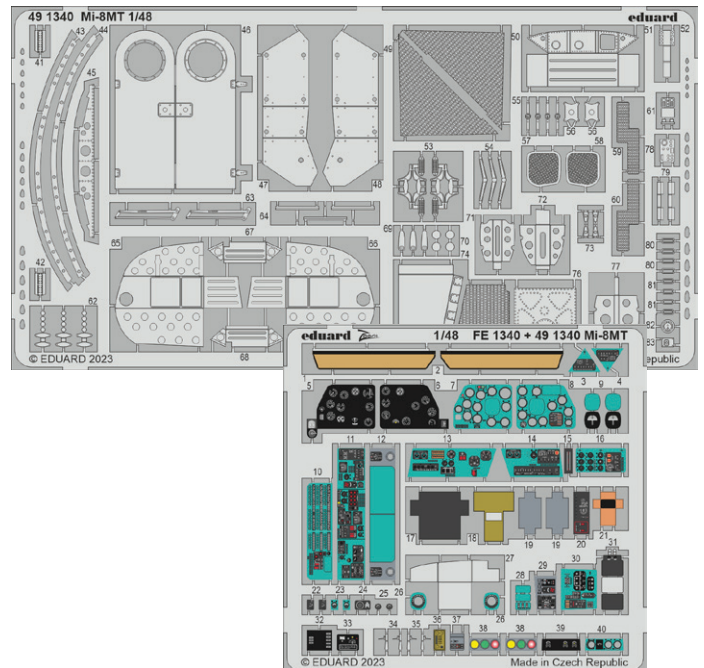

491342 F4U-1D
1/48 Hobby Boss

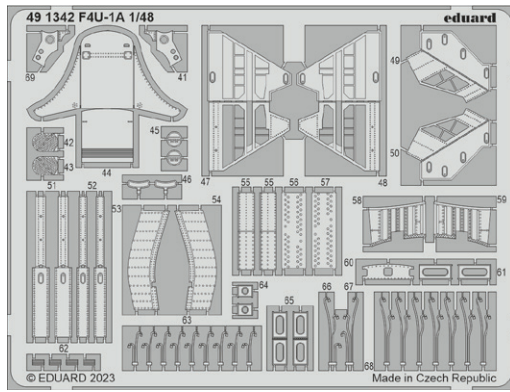

491344 A6M2b
1/48 Academy

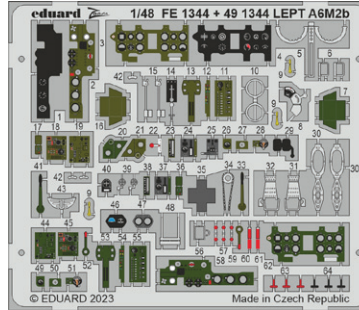
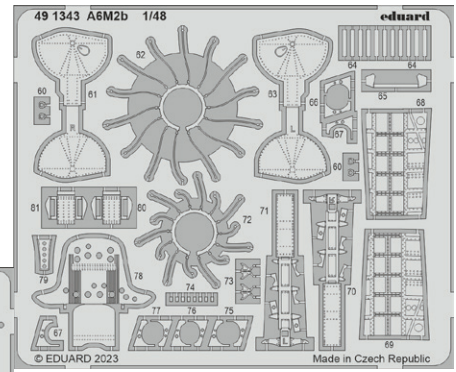
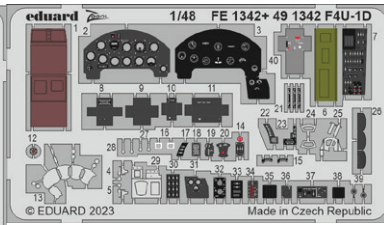

72730 F-14B exterior
1/72 Academy

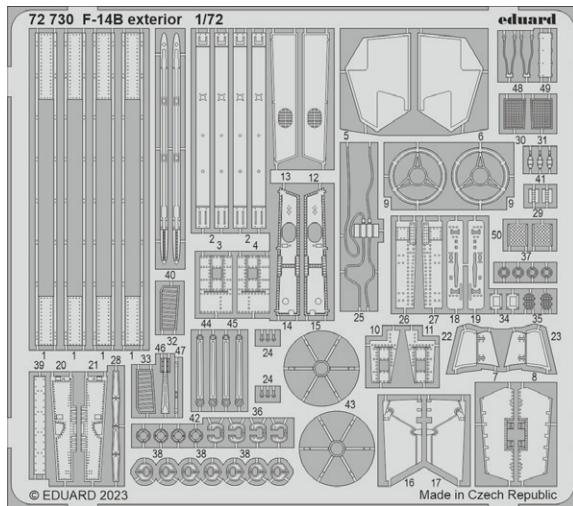

73799 U-2C 1/72
Hobby Boss

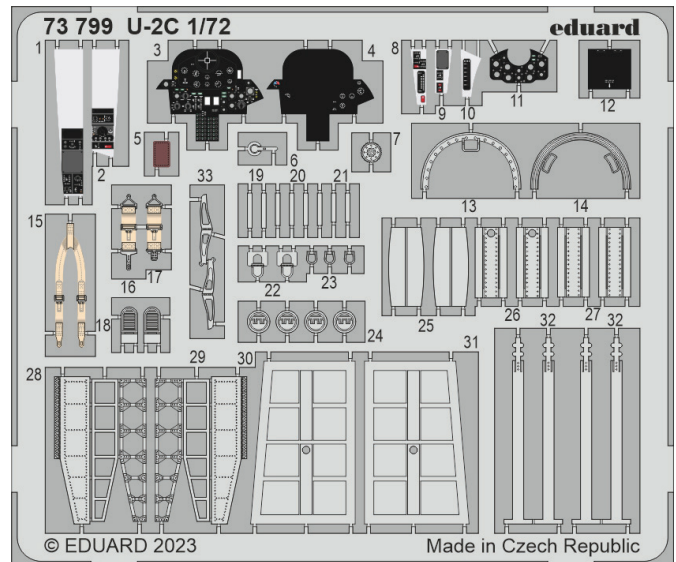

73800 F-14B
1/72 Academy

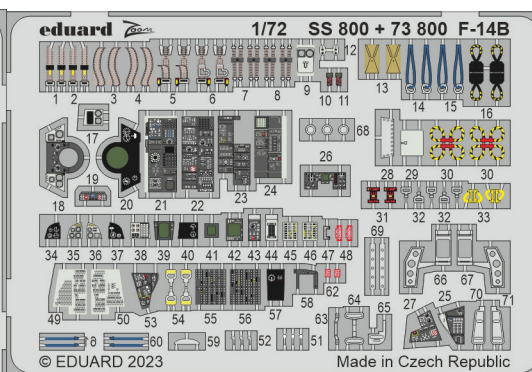
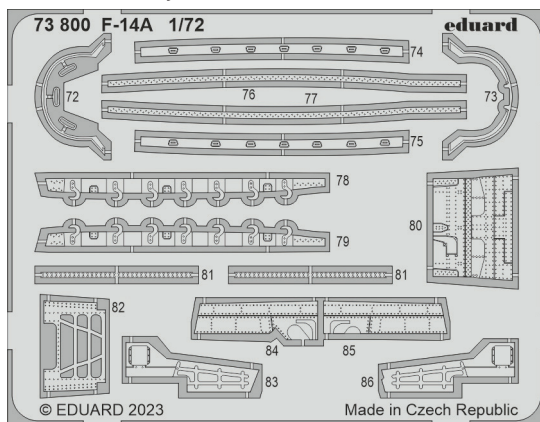

FE1340 Mi-8MT
1/48 Zvezda

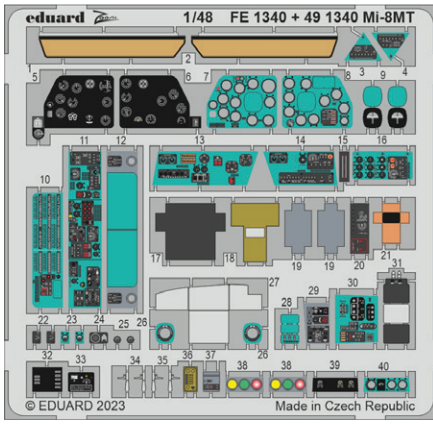

FE1341 Mi-8MT seatbelts STEEL
1/48 Zvezda

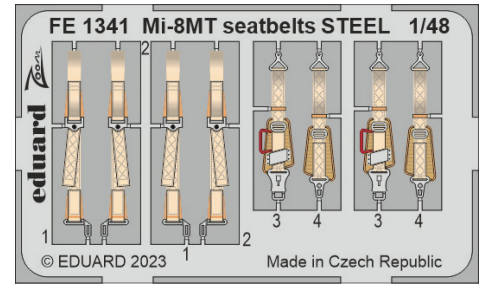

FE1342 F4U-1D
1/48 Hobby Boss

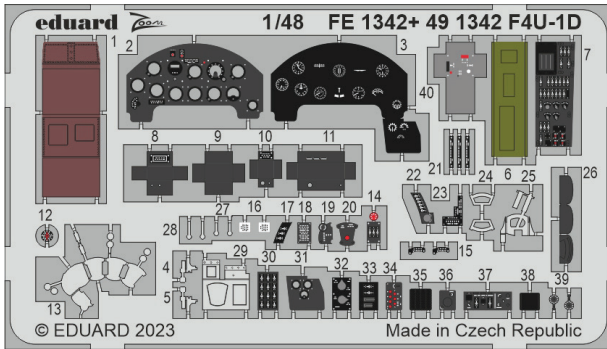

FE1343 F4U-1D seatbelts STEEL
1/48 Hobby Boss

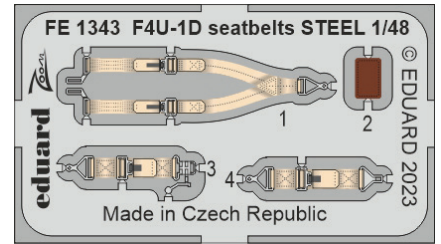

FE1344 A6M2b
1/48 Academy

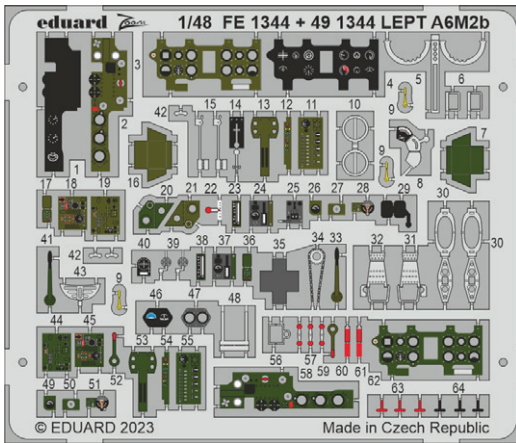

FE1345 A6M2b seatbelts STEEL
1/48 Academy

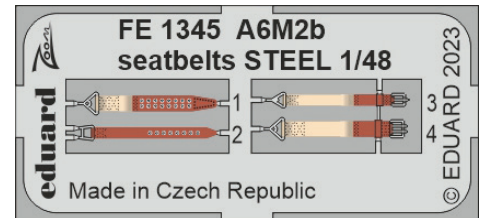

FE1346 Fw 190A-4 Weekend
1/48 Eduard

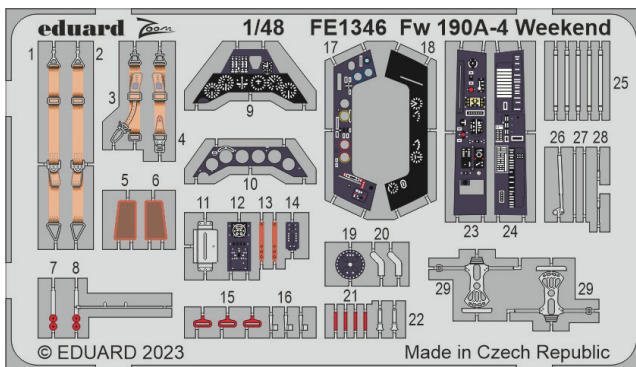

SS800 F-14B
1/72 Academy

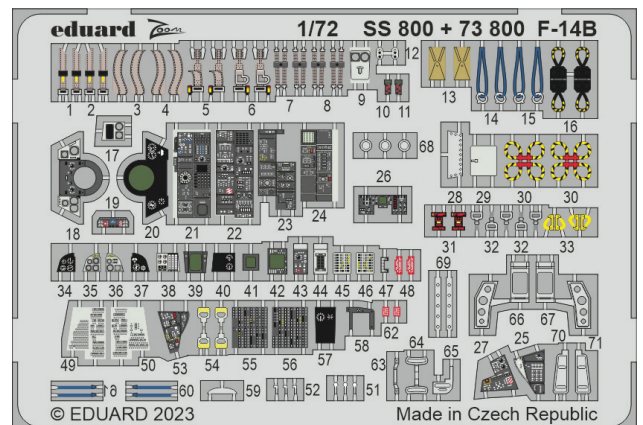

644205 A6M2-N Rufe Löök 1/48 Eduard

Löök set - Brassin pre-painted dashboard and STEEL seatbelts for A6M2-N Rufe in 1/48 scale. Easy to assemble, replaces plastic parts. Recommended kit: Eduard

Set contains:

- resin: 2 parts
- decals: no
- photo-etched details: yes, pre-painted
- painting mask: no

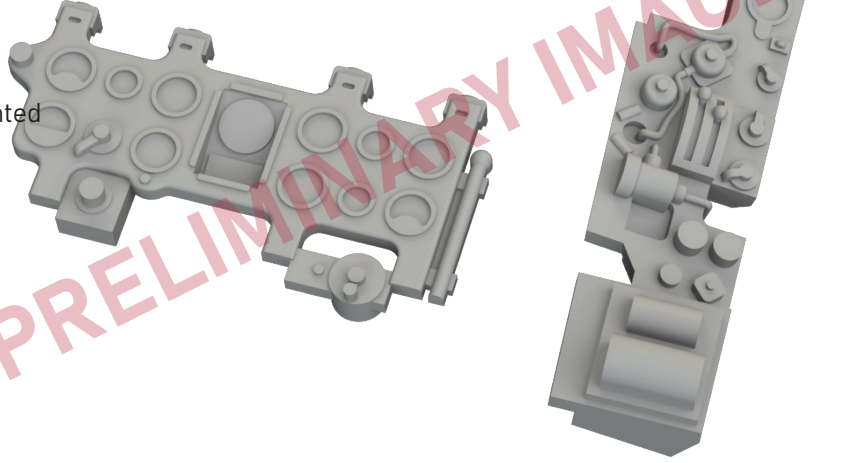

644206 B-25J Löök 1/48 HKM

Löök set - Brassin pre-painted dashboard and STEEL seatbelts for B-25J in 1/48 scale. Easy to assemble, replaces plastic parts. Recommended kit: HKM

Set contains:

- resin: 2 parts
- 3D print: 2 parts
- decals: no
- photo-etched details: yes, pre-painted
- painting mask: no

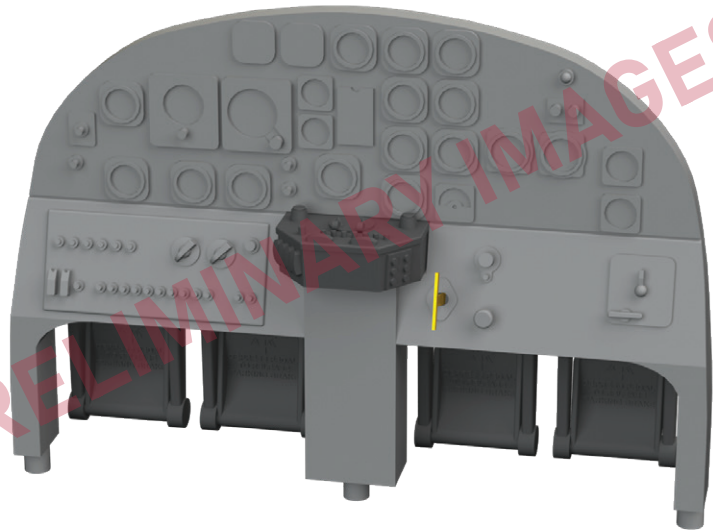

644207 F-16C Block 25 Löök 1/48 Kinetic

Löök set - Brassin pre-painted dashboard and STEEL seatbelts for F-16C Block 25 in 1/48 scale. Easy to assemble, replaces plastic parts. Recommended kit: Kinetic

Set contains:

- resin: 2 parts
- decals: no
- photo-etched details: yes, pre-painted
- painting mask: no



635024 WWII German 10 ton jacks PRINT 1/35

Brassin set - 10ton jacks for German WWII AFV in 1/35 scale. The set consists of 3 jacks. Made by direct 3D printing.

eduard
BRASSIN
Print

Set contains:

- 3D print: 15 parts
- decals: no
- photo-etched details: no
- painting mask: no

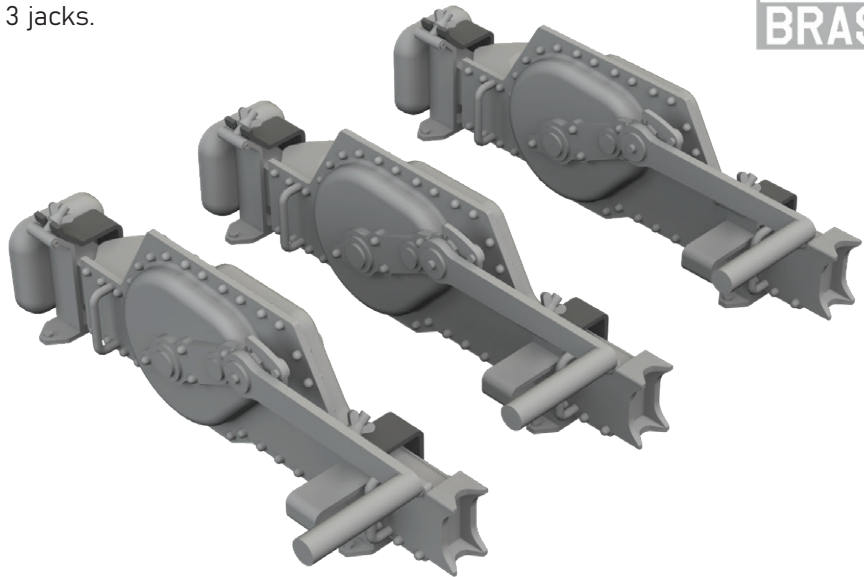

635026 WWII German wire cutters PRINT 1/35

Brassin set - wire cutters for German WWII AFV in 1/35 scale. The set consists of 5 wire cutters. Made by direct 3D printing.

eduard
BRASSIN
Print

Set contains:

- 3D print: 5 parts
- decals: no
- photo-etched details: yes
- painting mask: no



632188 Hurricane Mk.II exhaust rounded PRINT 1/32 Revell

Brassin set - exhaust stacks for Hurricane Mk.II in 1/32 scale. Made by direct 3D printing. Easy to assemble, replaces plastic parts. Recommended kit: Revell

eduard
BRASSIN
Print

Set contains:

- 3D print: 2 parts
- decals: no
- photo-etched details: no
- painting mask: no

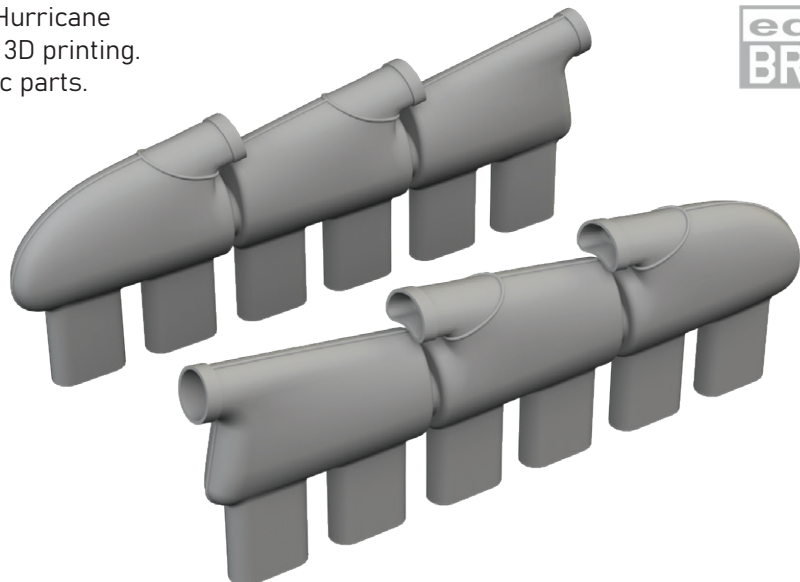

632189 Hurricane Mk.II exhaust fishtail PRINT 1/32 Revell

Brassin set - exhaust stacks for Hurricane Mk.II in 1/32 scale. Made by direct 3D printing. Easy to assemble, replaces plastic parts. Recommended kit: Revell

Set contains:

- 3D print: 2 parts
- decals: no
- photo-etched details: no
- painting mask: no

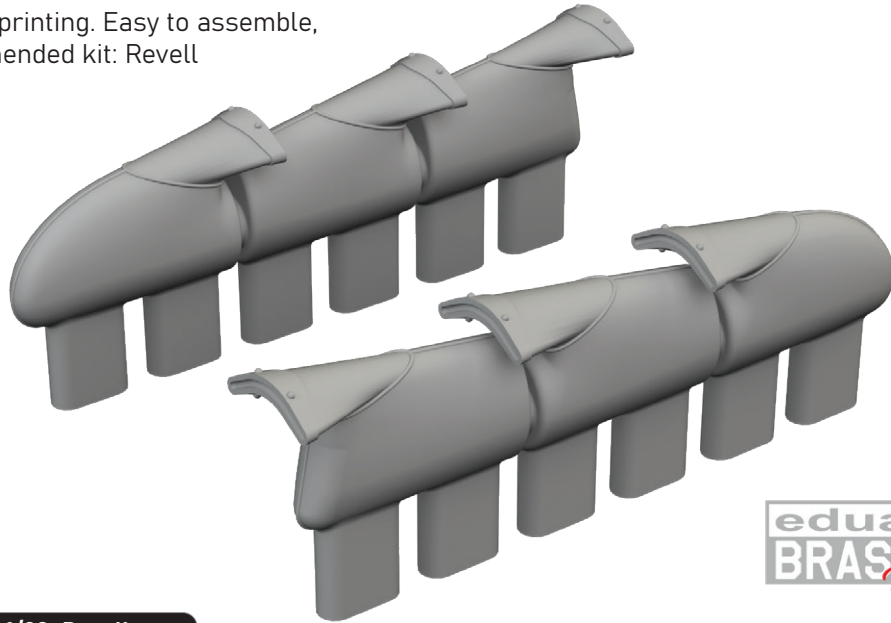

632190 Hurricane Mk.II wheels 1/32 Revell

Brassin set - the undercarriage wheels for Hurricane Mk.II in 1/32 scale. The set consists of the main wheels and a tail wheel. Easy to assemble, replaces plastic parts. Recommended kit: Revell

Set contains:

- resin: 3 parts
- 3D print: 2 parts
- decals: no
- photo-etched details: no
- painting mask: yes

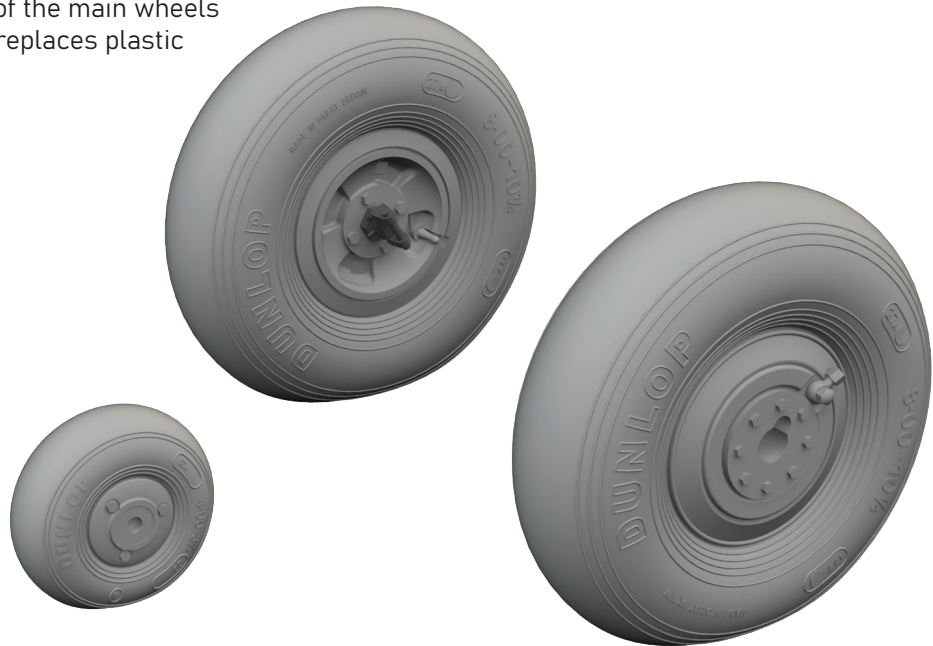

648826 F4F-3 engine late PRINT 1/48 Eduard

Brassin set - the engine for F4F-3 in 1/48 scale. The cowlings are included. Made by direct 3D printing. Recommended kit: Eduard

Set contains:

- 3D print: 36 parts
- decals: no
- photo-etched details: yes
- painting mask: no

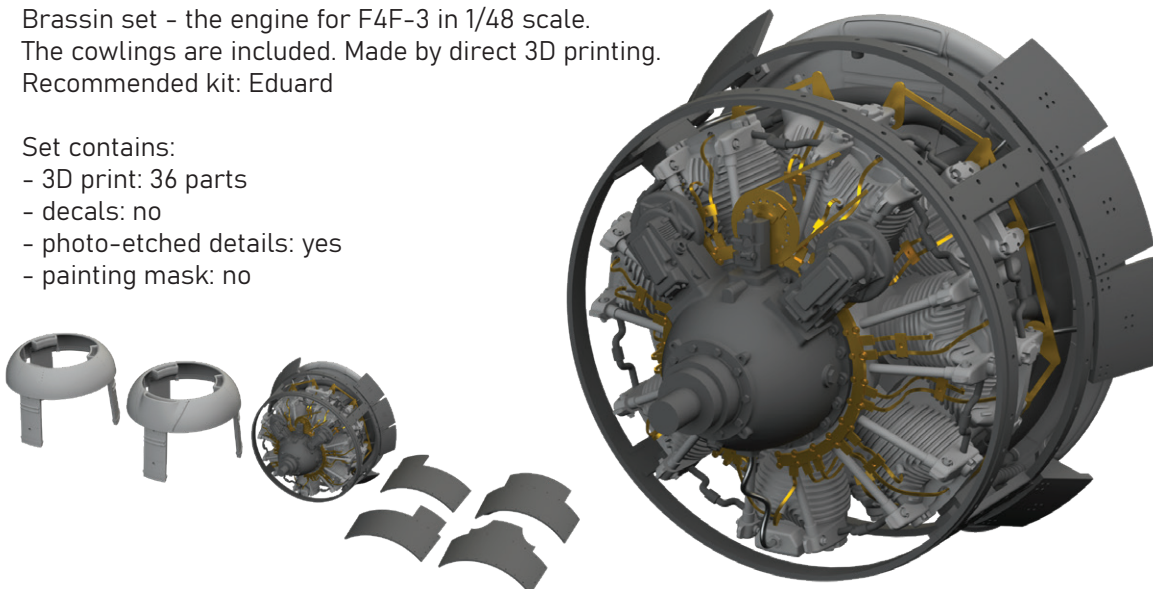

648842 A-1J seat PRINT 1/48 Tamiya

Brassin set - the seat for A-1J in 1/48 scale.
Seatbelts are printed together with the seat.
Easy to assemble, replaces plastic parts.
Recommended kit: Tamiya

Set contains:

- resin: 1 part
- decals: no
- photo-etched details: no
- painting mask: no



eduard
BRASSIN
Print

648844 Anson Mk.I guns PRINT 1/48 Airfix

Brassin set - guns for Anson Mk.I in 1/48 scale.
The set consists of the 4 guns. Made by direct
3D printing. Recommended kit: Airfix

Set contains:

- 3D print: 10 parts
- decals: no
- photo-etched details: yes
- painting mask: no

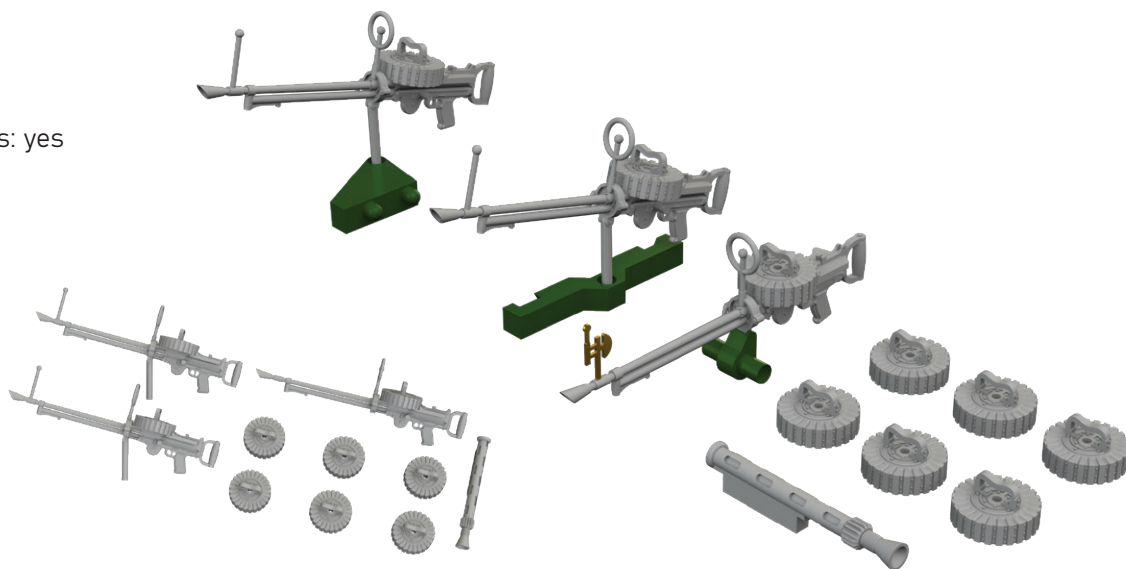

eduard
BRASSIN
Print

648845 A6M2-N Rufe seat PRINT 1/48 Eduard

Brassin set - seat for A6M2-N Rufe in 1/48 scale.
Easy to assemble, replaces plastic parts.
Made by direct 3D printing. Recommended kit: Eduard

Set contains:

- 3D print: 1 part
- decals: no
- photo-etched details: yes, pre-painted
- painting mask: no

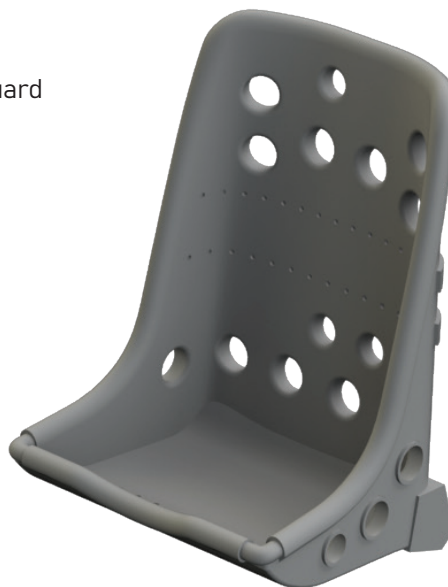

eduard
BRASSIN
Print

648846 A6M2-N Rufe exhaust PRINT 1/48 Eduard

Brassin set - exhaust pipes for A6M2-N Rufe in 1/48 scale. Easy to assemble, replaces plastic parts. Made by direct 3D printing. Recommended kit: Eduard



Set contains:

- 3D print: 4 parts
- decals: no
- photo-etched details: no
- painting mask: no

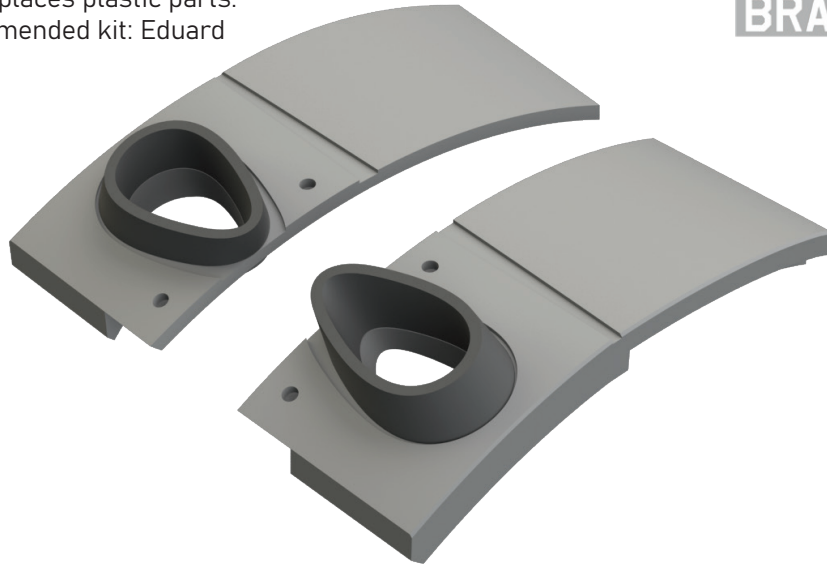

648847 A6M2-N Rufe cannon barrels & cockpit guns 1/48 Eduard

Brassin set - gun barrels for A6M2-N Rufe in 1/48 scale. Easy to assemble, replaces plastic parts. Made by direct 3D printing. Recommended kit: Eduard

Set contains:

- 3D print: 4 parts
- decals: no
- photo-etched details: yes
- painting mask: no

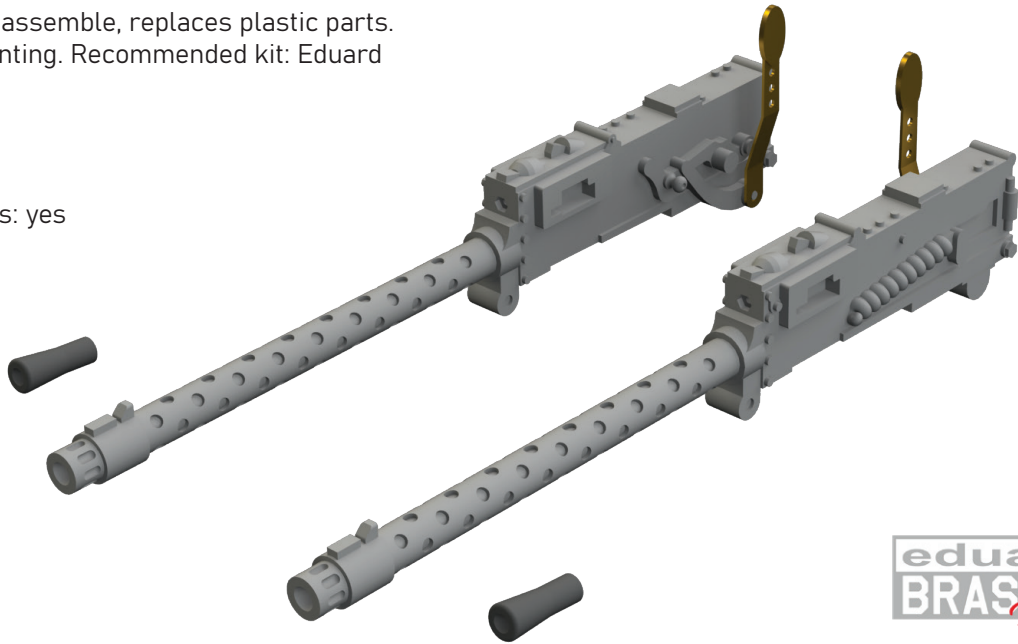

648848 A6M2-N Rufe folding wingtips PRINT 1/48 Eduard

Brassin set - folding wingtips for A6M2-N Rufe in 1/48 scale. Made by direct 3D printing. Recommended kit: Eduard



Set contains:

- 3D print: 4 parts
- decals: no
- photo-etched details: yes
- painting mask: no

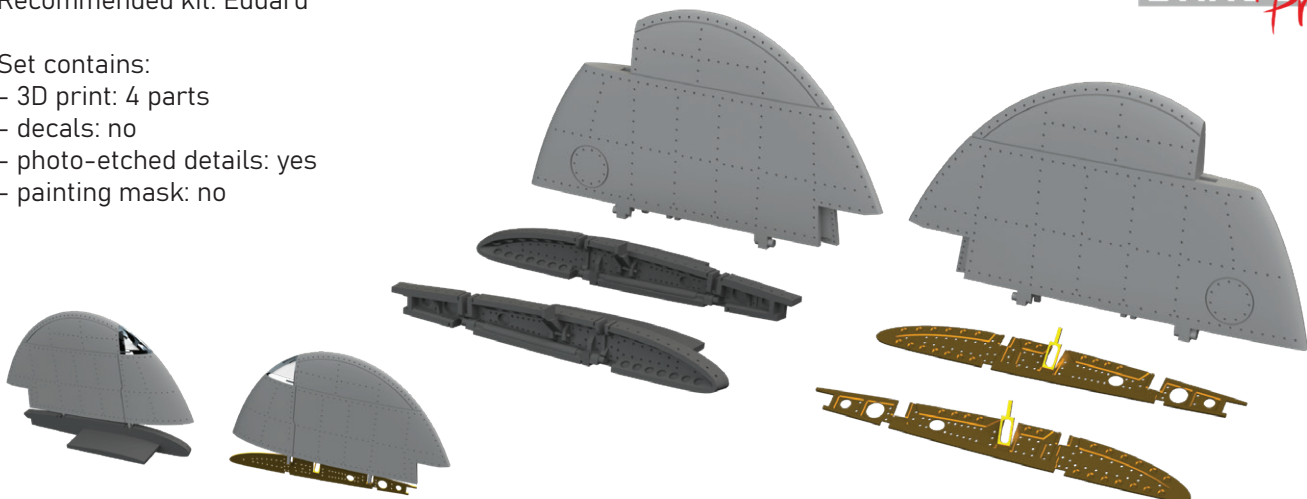

648849 A6M2-N Rufe gun bays PRINT 1/48 Eduard

Brassin set - gun bays for A6M2-N Rufe in 1/48 scale. Made by direct 3D printing. Recommended kit: Eduard

Set contains:

- 3D print: 16 parts
- decals: no
- photo-etched details: yes
- painting mask: no

eduard
BRASSIN
Print

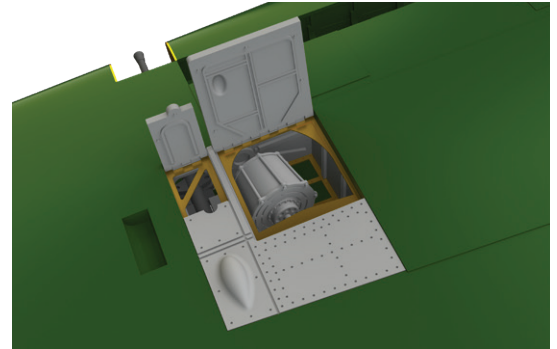
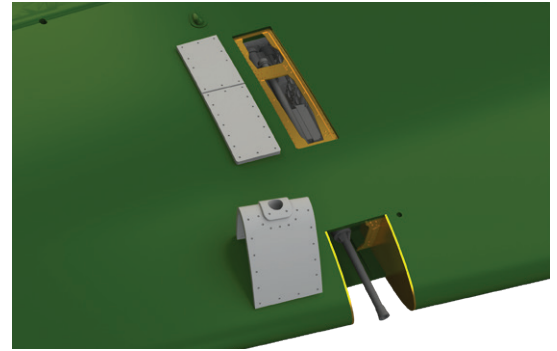
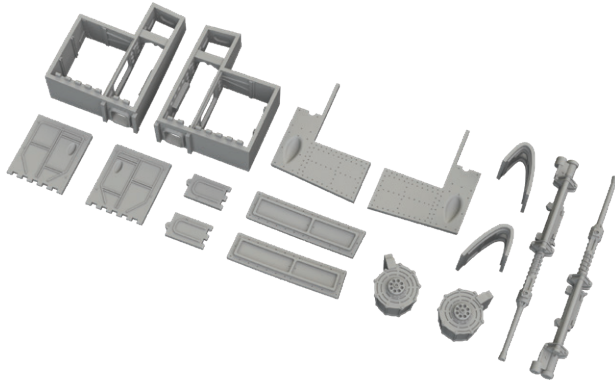

648854 F-16 exhaust nozzle P&W F100 PRINT 1/48 Kinetic

Brassin set - exhaust nozzle for P&W F100 powered F-16 in 1/48 scale. Made by direct 3D printing. Recommended kit: Kinetic

Set contains:

- 3D print: 4 parts
- decals: no
- photo-etched details: no
- painting mask: no

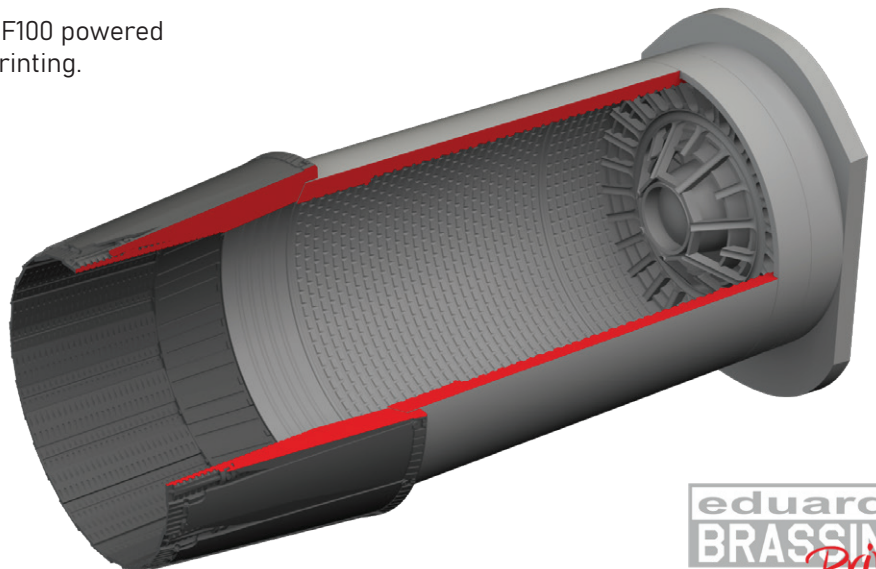

eduard
BRASSIN
Print

648855 F-16 radar early PRINT 1/48 Kinetic

Brassin set - nose radar for F-16 in 1/48 scale. Made by direct 3D printing. Recommended kit: Kinetic

Set contains:

- 3D print: 5 parts
- decals: no
- photo-etched details: no
- painting mask: no

eduard
BRASSIN
Print

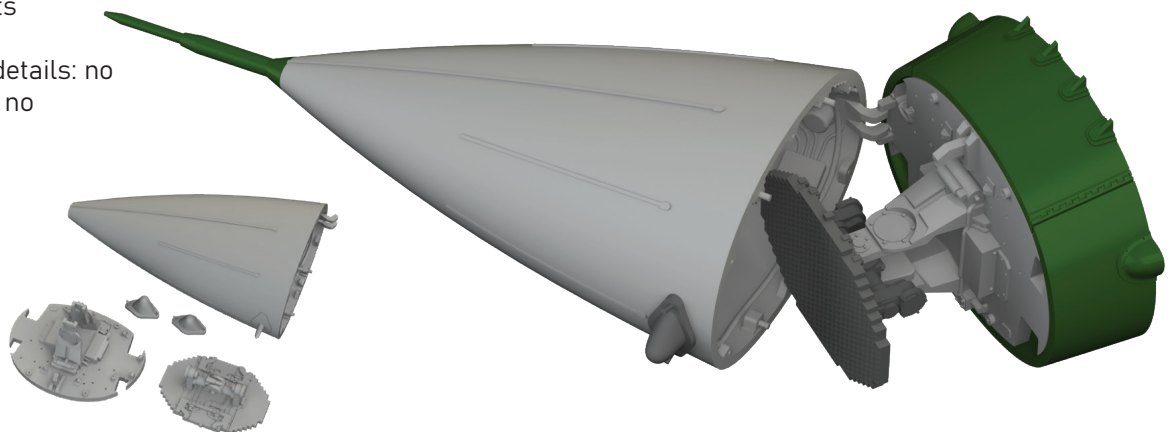

648857 Mi-24V cockpit turquoise PRINT & SPACE 1/48 Eduard/Zvezda

Brassin set - turquoise-painted cockpit for Mi-24V in 1/48 scale. Made by direct 3D printing. Recommended kit: Eduard / Zvezda



Set contains:

- 3D print: 10 parts
- resin: 46 parts
- decals: no
- photo-etched details: yes, pre-painted
- painting mask: no
- SPACE 3D decals: yes

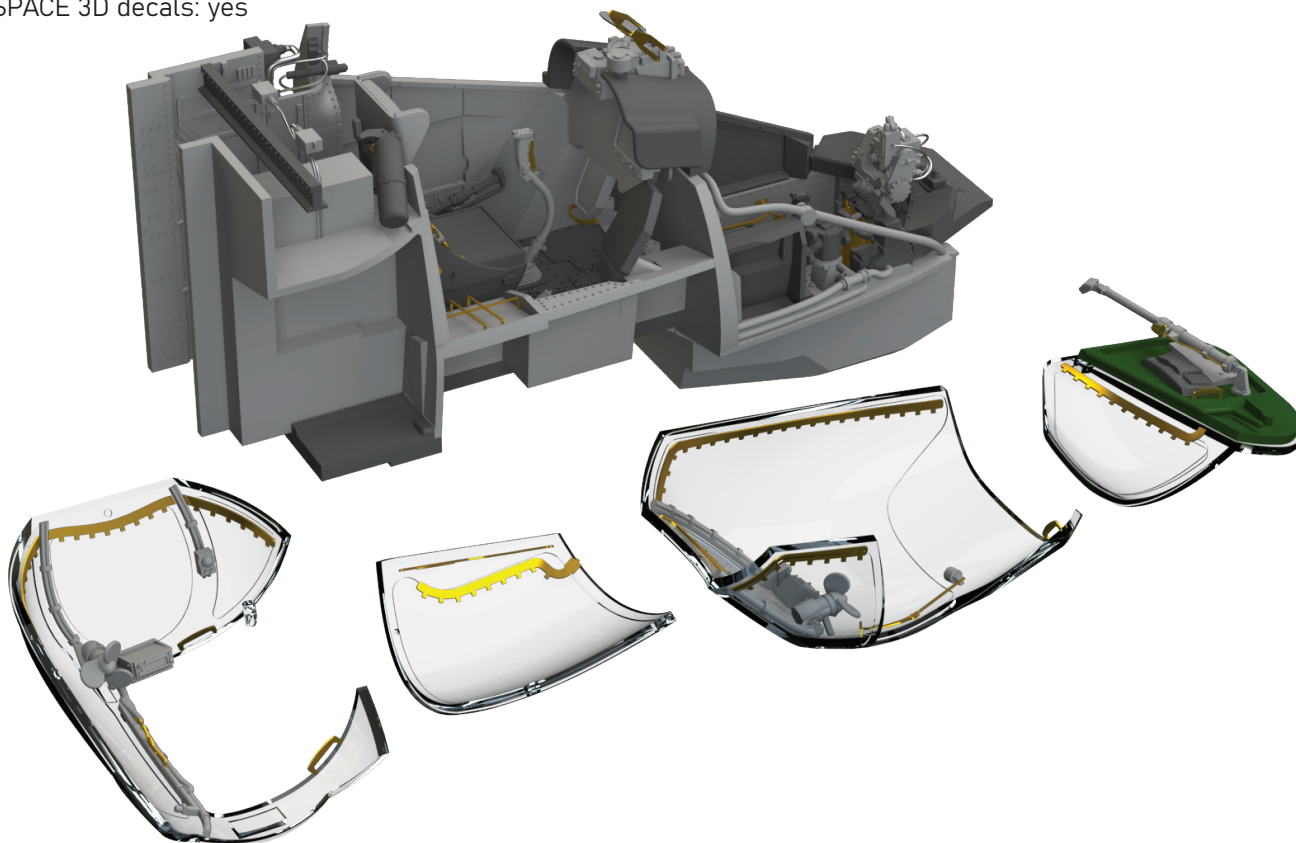

672310 Bf 110E wheels 1/72 Eduard

Brassin set - the undercarriage wheels for Bf 110E in 1/72 scale. The set consists of the main wheels and a tail wheel. Easy to assemble, replaces plastic parts. Recommended kit: Eduard



Set contains:

- resin: 3 parts
- decals: no
- photo-etched details: no
- painting mask: yes



672311 Bf 110E nose guns PRINT 1/72 Eduard

Brassin set - nose guns for Bf 110E in 1/72 scale.
Made by direct 3D printing. Recommended kit: Eduard



Set contains:

- 3D print: 13 parts
- decals: no
- photo-etched details: yes
- painting mask: no

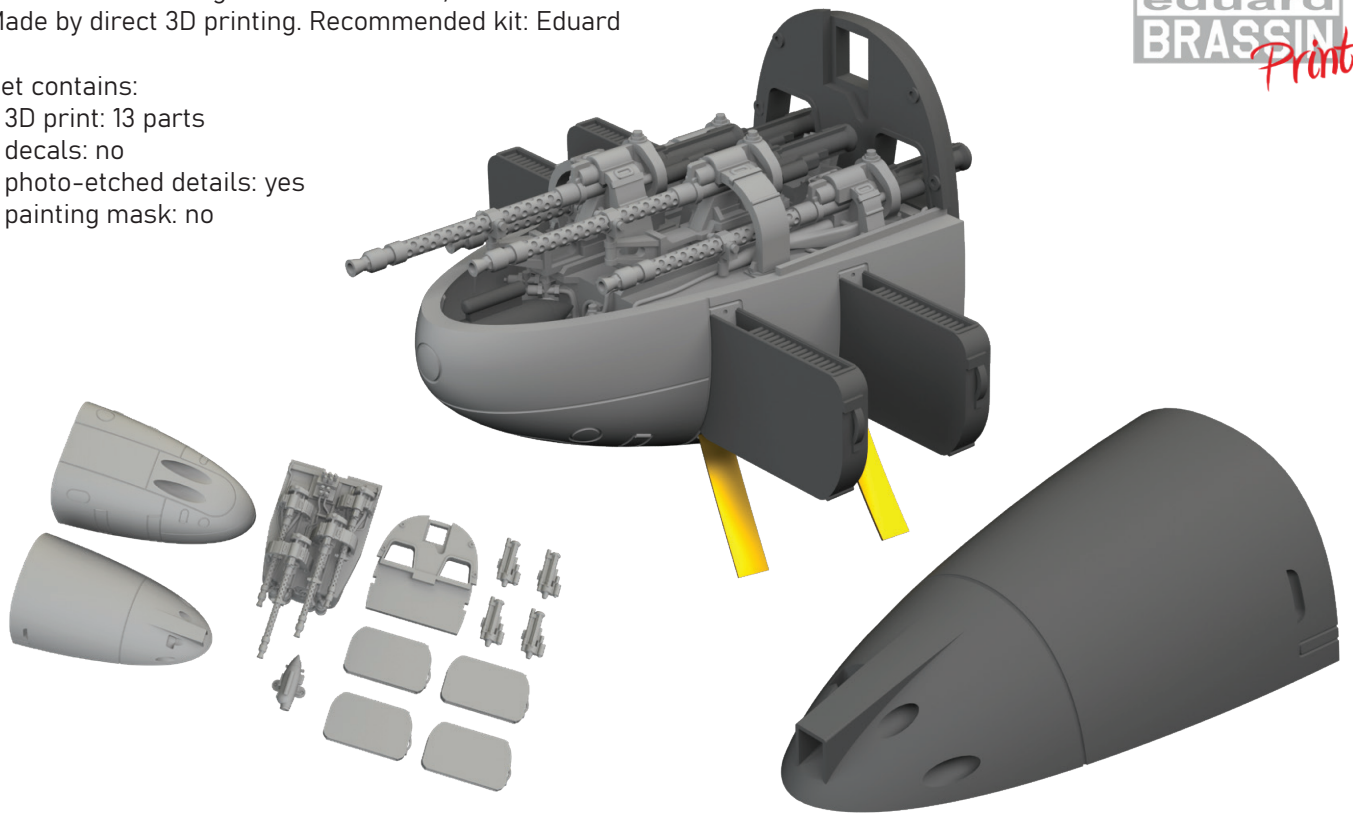

672312 Bf 110E cockpit 1/72 Eduard

Brassin set - the cockpit for Bf 110E
in 1/72 scale. Recommended kit: Eduard

Set contains:

- 3D print: 4 parts
- resin: 25 parts
- decals: yes
- photo-etched details: yes, pre-painted
- painting mask: no

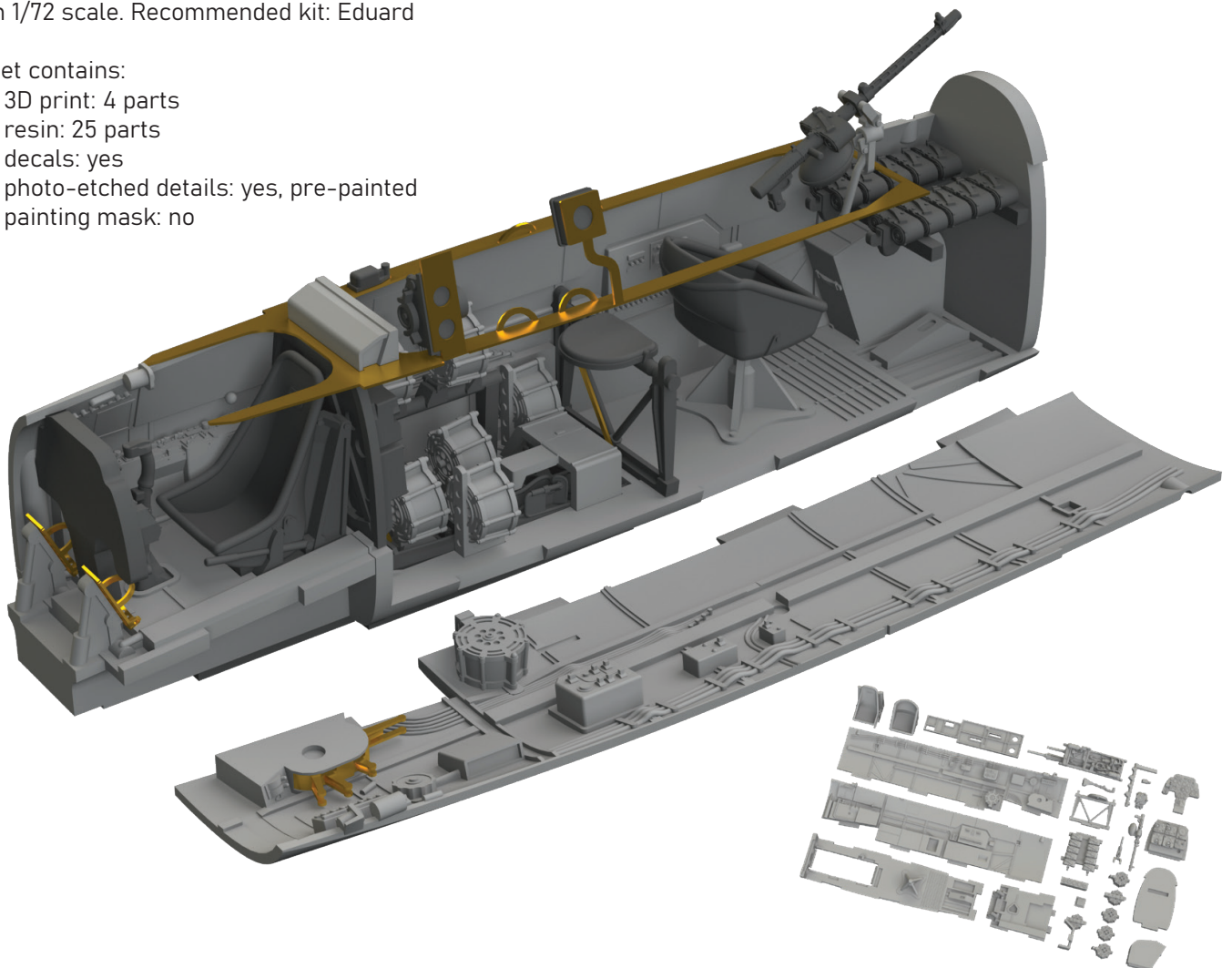

634032 Bf 109G-4 LööKplus 1/32 Revell

Collection of 4 sets for Bf 109G-4 in 1/32 scale.
Recommended kit: Revell

- LööK set (pre-painted Brassin dashboards & Steelbelts)
- TFace painting mask
- exhaust stacks
- undercarriage wheels

LööK+

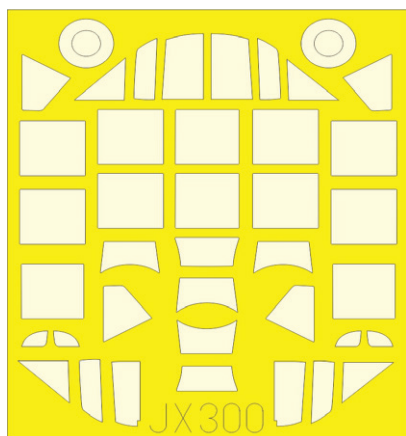

644204 Anson Mk.I LööKplus 1/48 Airfix

Collection of 4 sets for Anson Mk.I in 1/48 scale.
Recommended kit: Airfix

- LööK set (pre-painted Brassin dashboards & Steelbelts)
- TFace painting mask
- radiators
- undercarriage wheels

LööKt

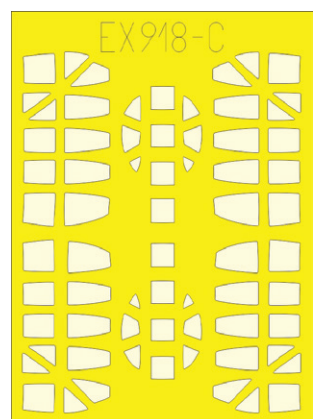
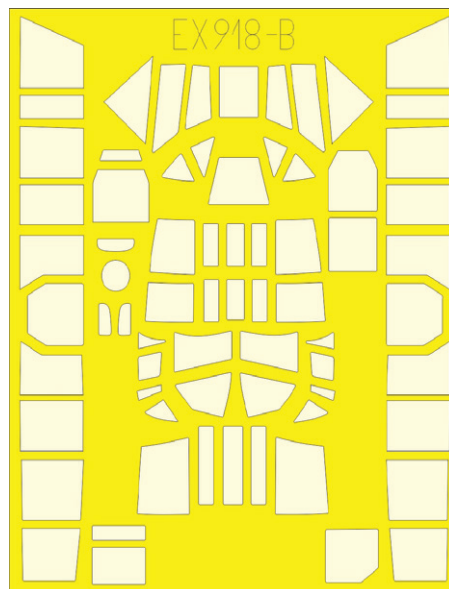
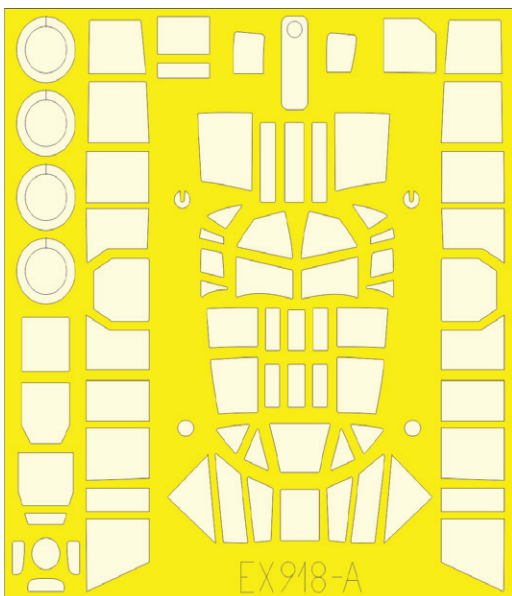
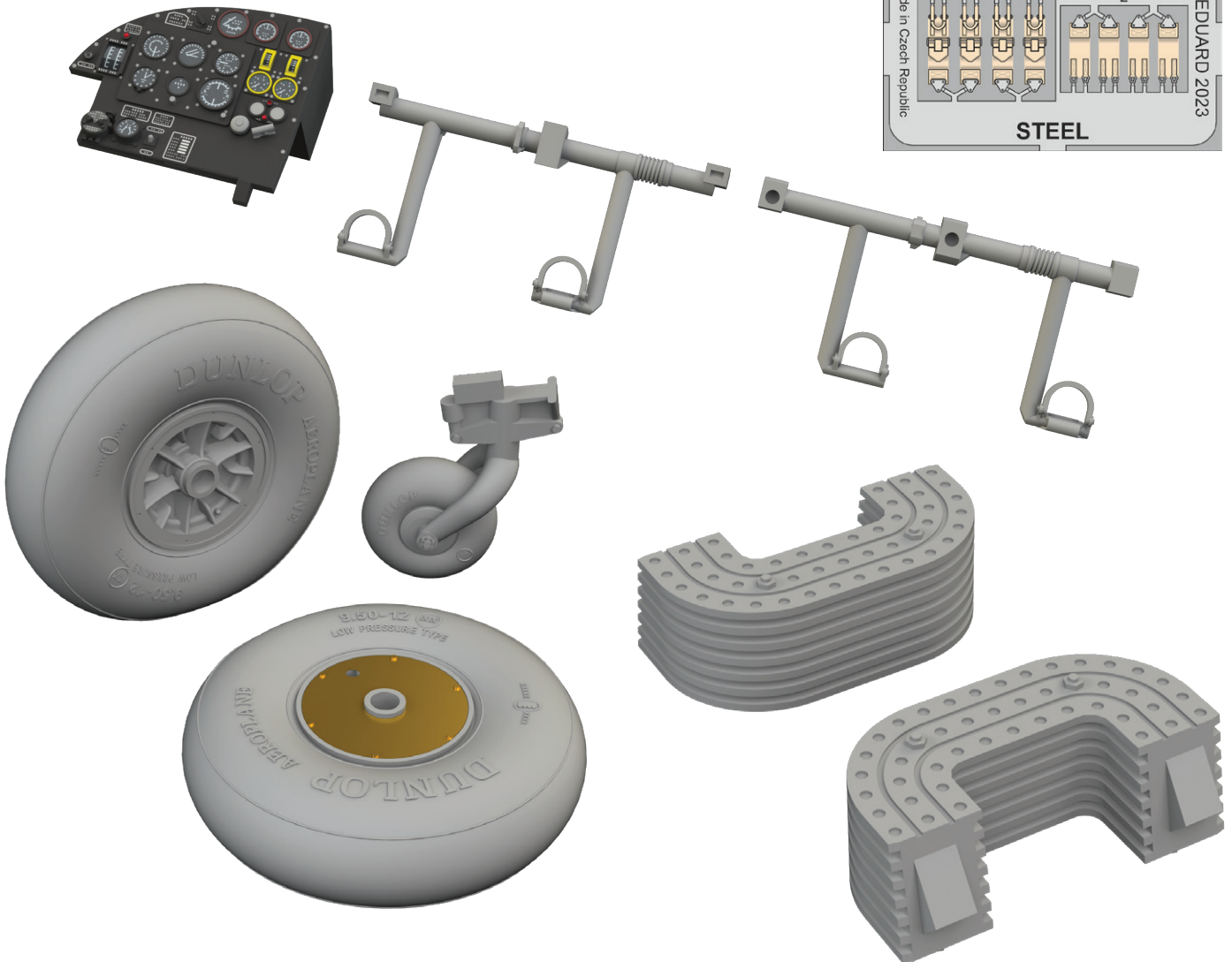
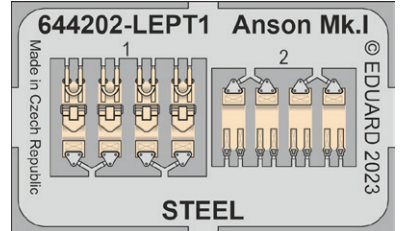

674003 P-39Q LööKplus 1/72 Arma Hobby

Collection of 4 sets for P-39Q in 1/72 scale.
Recommended kit: Arma Hobby

- LööK set (pre-painted Brassin dashboards & Steelbelts)
- seat
- exhaust stacks
- gun barrells

LööK+

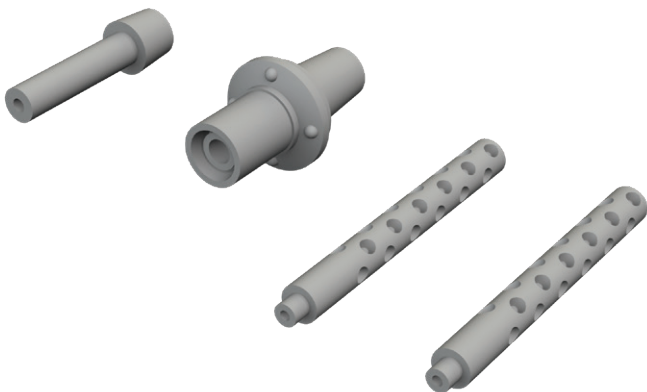
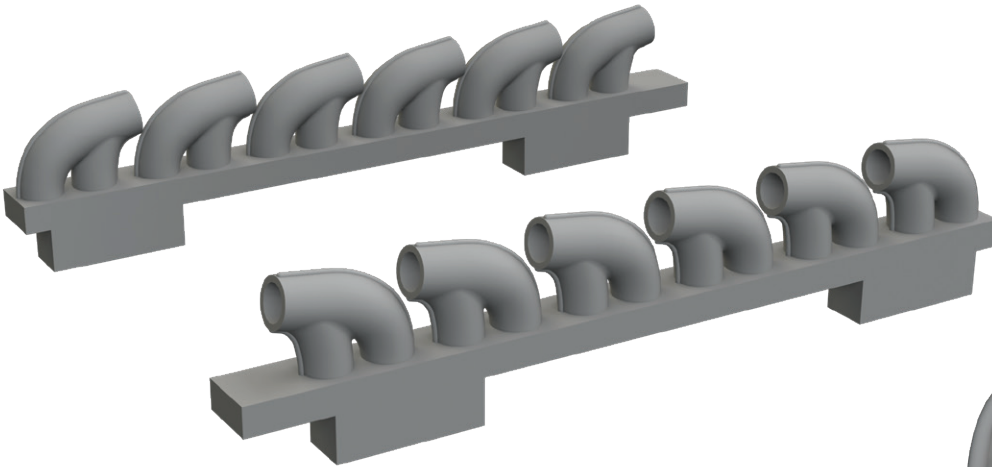
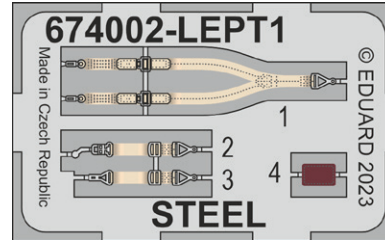
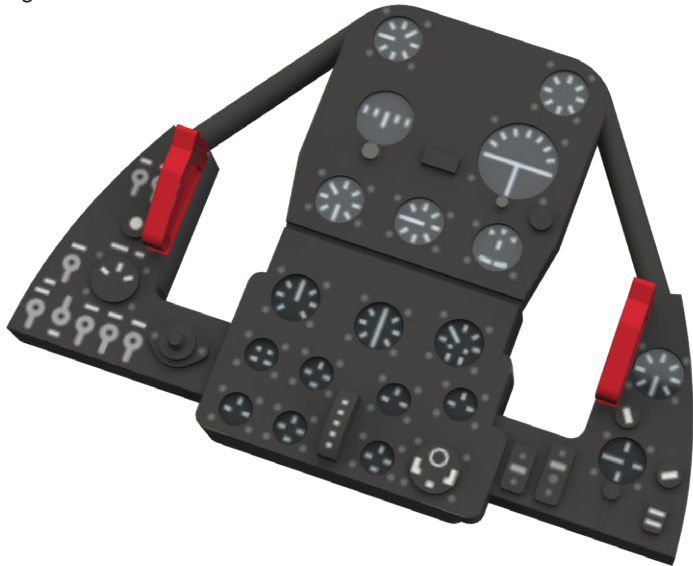

SIN63216 Tornado IDS armament 1/32 Italeri

Collection of 6 sets for Tornado IDS in 1/32 scale.
Recommended kit: Italeri

- AIM-9M/L Sidewinder
- AGM-88 HARM
- BOZ-107 pod (2 sets)
- AN/AAQ-28(V) Litening pod
- GBU-24 bomb

All sets included in this BIG SIN are available separately, but with every BIG SIN set you save up to 30 %.

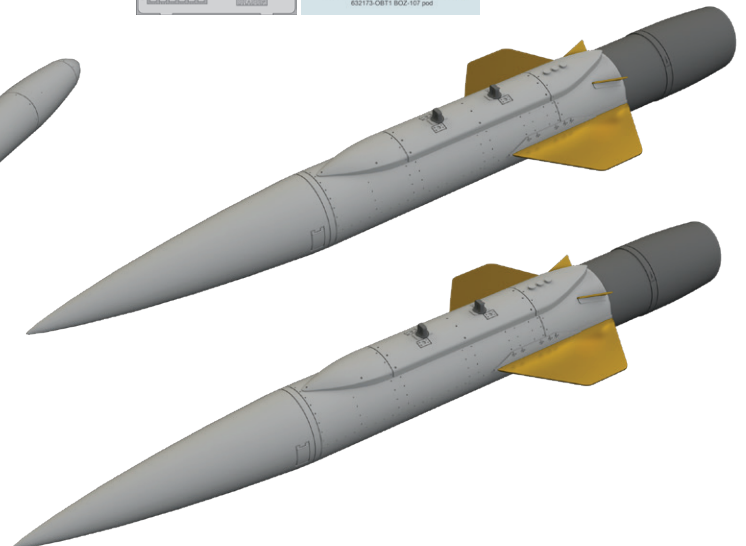
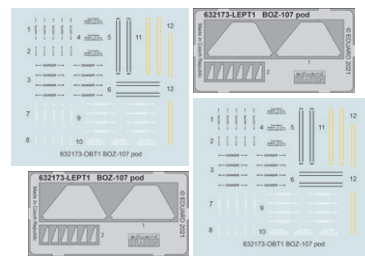
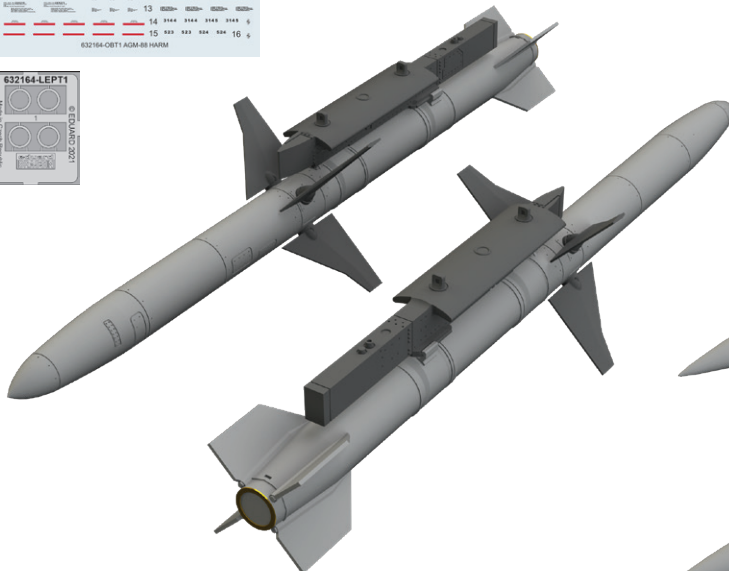
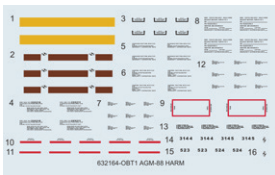
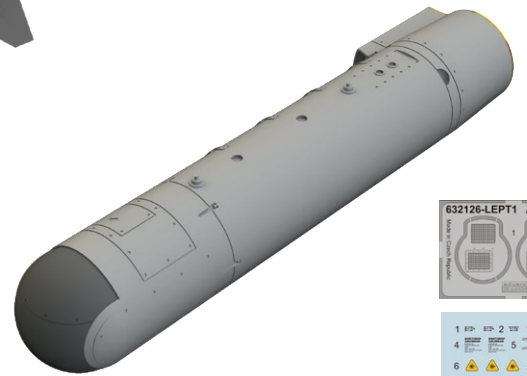
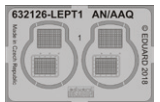
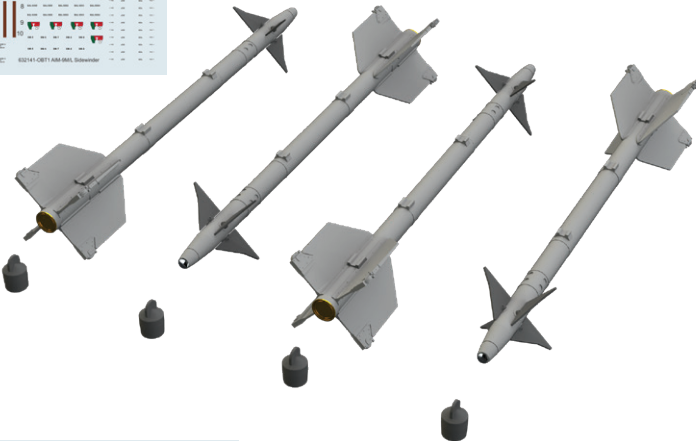
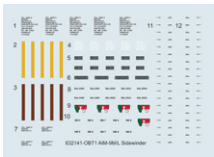
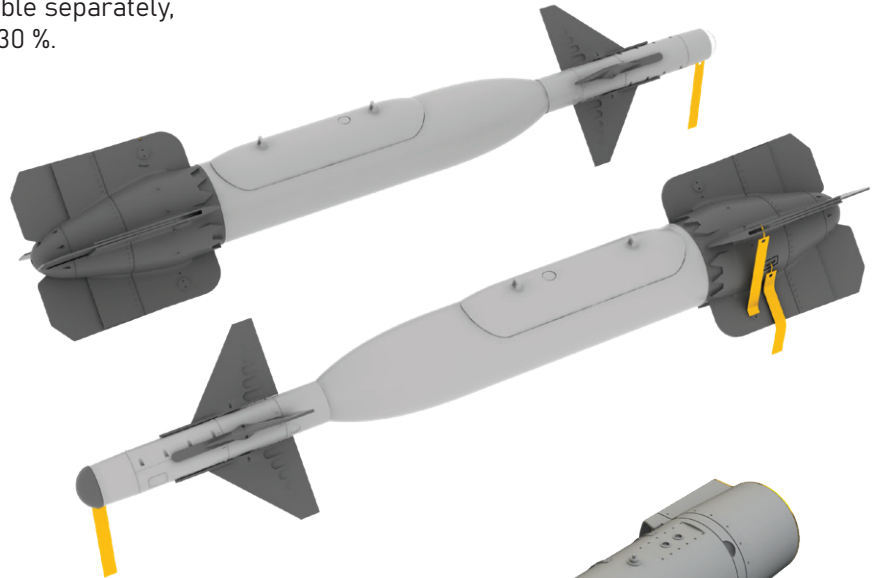

SIN648102 F-14D 1/48 Tamiya

Collection of 4 sets for F-14D in 1/48 scale.
Recommended kit: Tamiya

- undercarriage wheels
- cockpit
- exhaust nozzles
- Remove Before Flight tags SPACE

All sets included in this BIG SIN are available separately, but with every BIG SIN set you save up to 30 %.

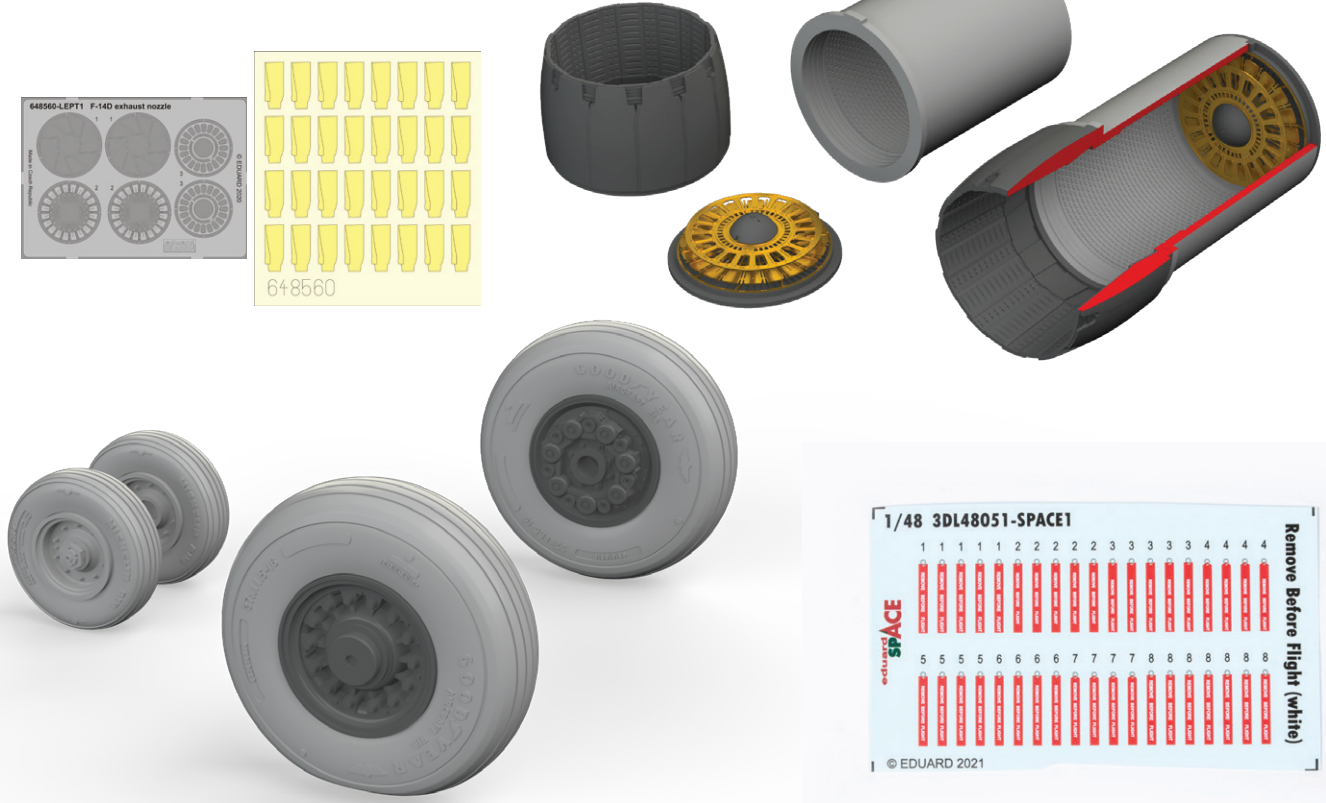

1/48 3DL48051-SPACE

| | | | | | | | | | | | | | | | | |
|---|---|---|---|---|---|---|---|---|---|---|---|---|---|---|---|---|
| 1 | 1 | 1 | 1 | 1 | 2 | 2 | 2 | 2 | 3 | 3 | 3 | 3 | 4 | 4 | 4 | 4 |
| 5 | 5 | 5 | 5 | 6 | 6 | 6 | 6 | 7 | 7 | 7 | 8 | 8 | 8 | 8 | 8 | 8 |

Remove Before Flight (white)

© EDUARD 2021

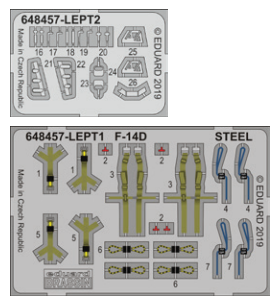
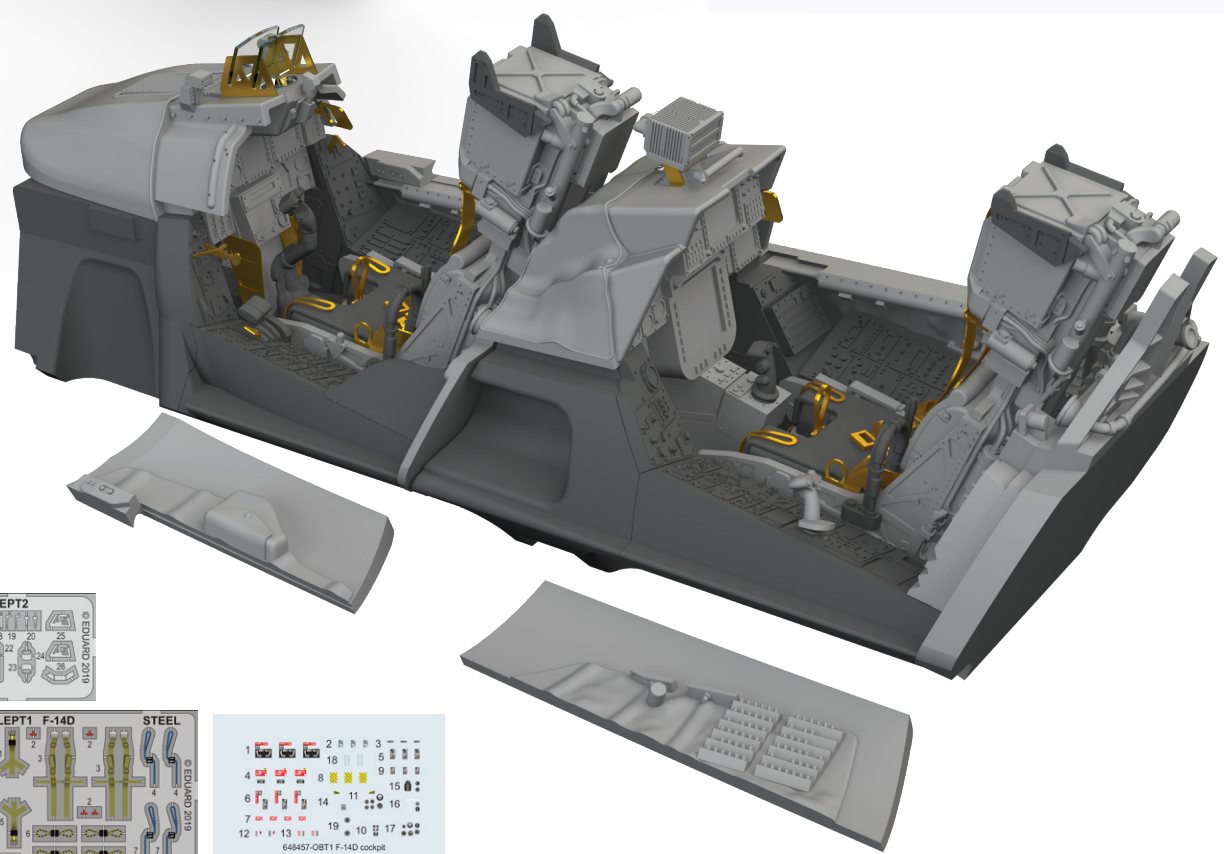

648457-OBT1 F-14D cockpit

| | | | | | | | | | | | | | | | | | | | | | | | | | | | | | | | | | | | | | | | | | | | | | | | | | | | | | | | | | | | | | | | | | | | | | | | | | | | | | | | | | | | | | | | | | | | | | | | | | | | |
|---|---|---|---|---|---|---|---|---|----|----|----|----|----|----|----|----|----|----|----|----|----|----|----|----|----|----|----|----|----|----|----|----|----|----|----|----|----|----|----|----|----|----|----|----|----|----|----|----|----|----|----|----|----|----|----|----|----|----|----|----|----|----|----|----|----|----|----|----|----|----|----|----|----|----|----|----|----|----|----|----|----|----|----|----|----|----|----|----|----|----|----|----|----|----|----|----|----|----|-----|
| 1 | 2 | 3 | 4 | 5 | 6 | 7 | 8 | 9 | 10 | 11 | 12 | 13 | 14 | 15 | 16 | 17 | 18 | 19 | 20 | 21 | 22 | 23 | 24 | 25 | 26 | 27 | 28 | 29 | 30 | 31 | 32 | 33 | 34 | 35 | 36 | 37 | 38 | 39 | 40 | 41 | 42 | 43 | 44 | 45 | 46 | 47 | 48 | 49 | 50 | 51 | 52 | 53 | 54 | 55 | 56 | 57 | 58 | 59 | 60 | 61 | 62 | 63 | 64 | 65 | 66 | 67 | 68 | 69 | 70 | 71 | 72 | 73 | 74 | 75 | 76 | 77 | 78 | 79 | 80 | 81 | 82 | 83 | 84 | 85 | 86 | 87 | 88 | 89 | 90 | 91 | 92 | 93 | 94 | 95 | 96 | 97 | 98 | 99 | 100 |
|---|---|---|---|---|---|---|---|---|----|----|----|----|----|----|----|----|----|----|----|----|----|----|----|----|----|----|----|----|----|----|----|----|----|----|----|----|----|----|----|----|----|----|----|----|----|----|----|----|----|----|----|----|----|----|----|----|----|----|----|----|----|----|----|----|----|----|----|----|----|----|----|----|----|----|----|----|----|----|----|----|----|----|----|----|----|----|----|----|----|----|----|----|----|----|----|----|----|----|-----|

BACK

BIG SIN SETS

BIG33150 Tornado IDS 1/32 Italeri

- 32480 Tornado IDS exterior 1/32
- 321004 Tornado IDS interior 1/32
- 321005 Tornado IDS undercarriage 1/32
- 33342 Tornado IDS seatbelts STEEL 1/32
- JX303 Tornado IDS 1/32

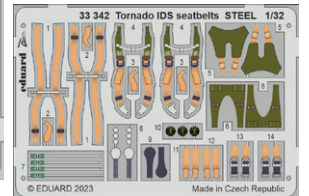
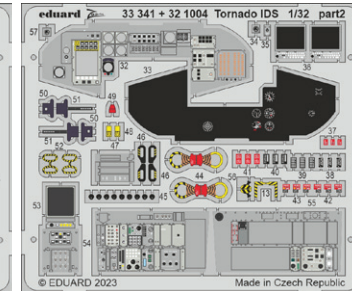
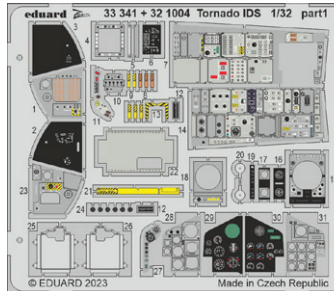
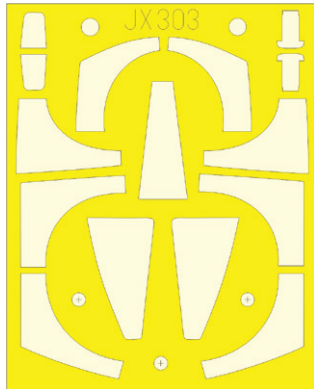
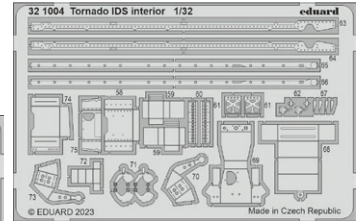
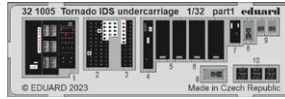
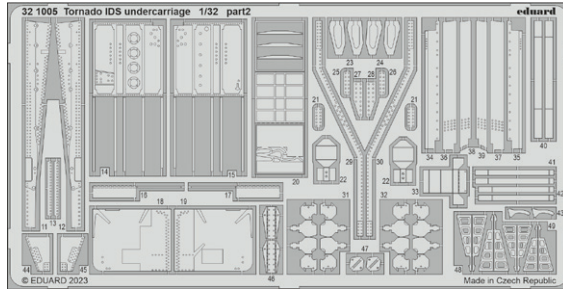
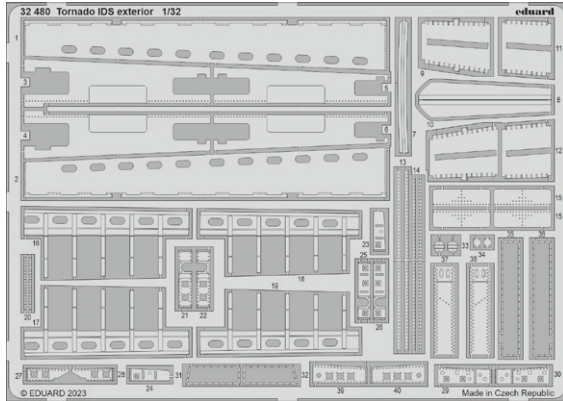

BIG49361 Beaufort Mk.I PART II 1/48 ICM

- 481094 Beaufort Mk.I bomb bay 1/48
- 481095 Beaufort Mk.I landing flaps 1/48
- 481096 Beaufort Mk.I undercarriage 1/48

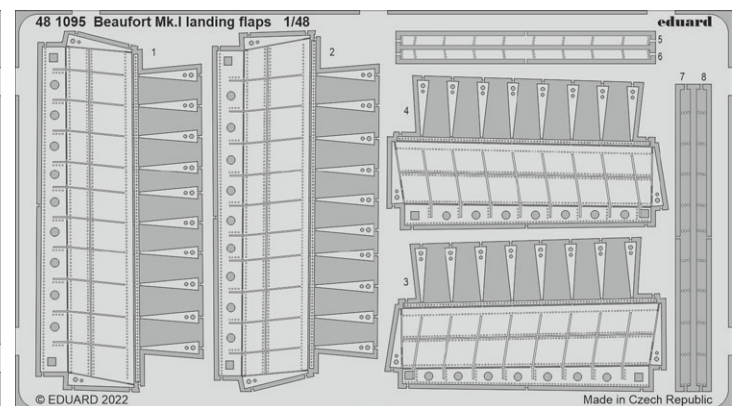
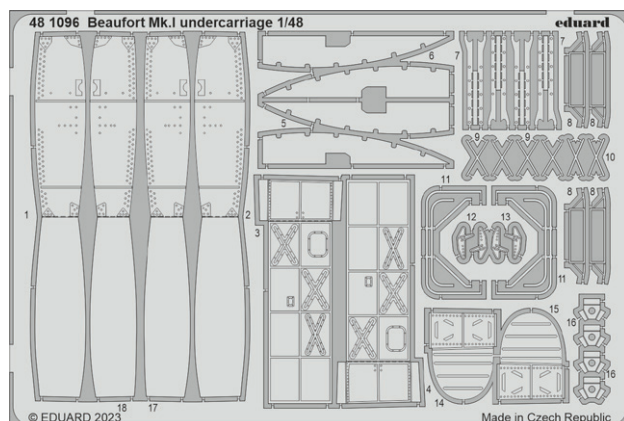
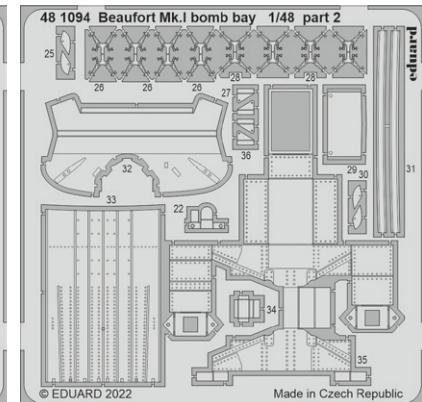
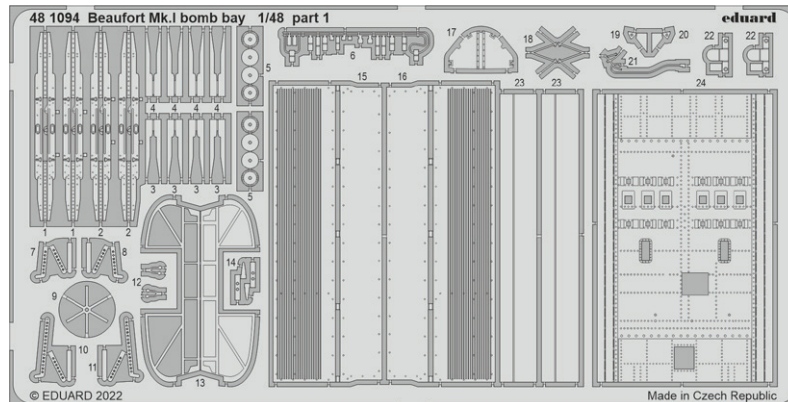

- 481097 A-10C exterior 1/48
- 481098 A-10C armament 1/48
- 491324 A-10C 1/48
- FE1325 A-10C seatbelts STEEL 1/48
- EX915 A-10C 1/48

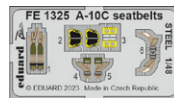
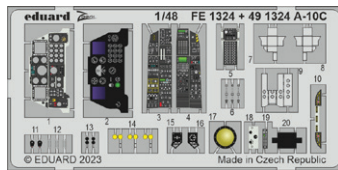
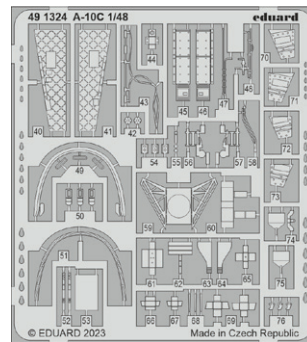
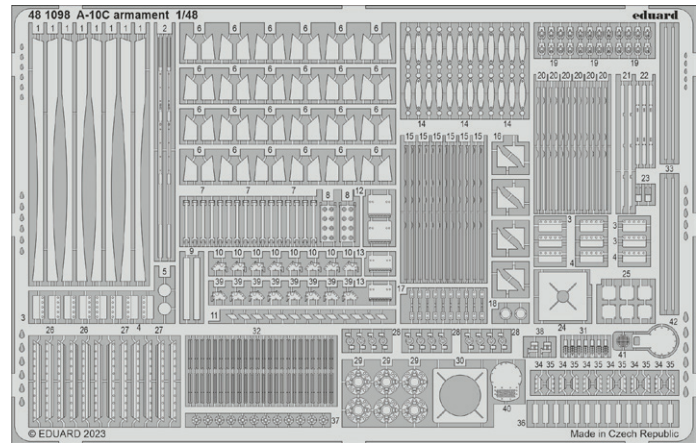
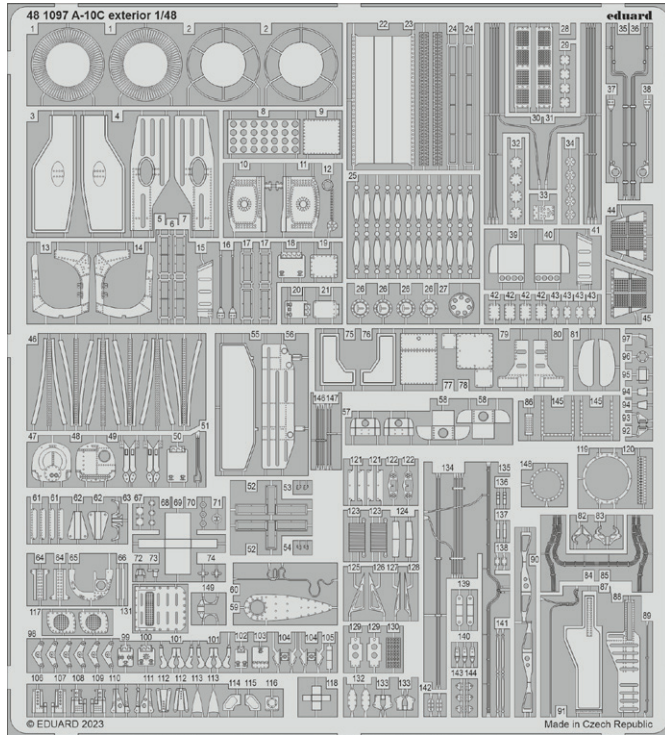

#SIN64100

F-35A armament

1/48 TAMIYA

Collection of 6 sets for F-35A in 1/48 scale.
Recommended kit: Tamiya

- AIM-120C AMRAAM (2 sets)
- AIM-9X
- AIM-132 ASRAAM
- GBU-12 bomb
- GBU-31(V)1/B JDAM

All sets included in this BIG SIN are available separately,
but with every BIG SIN set you save up to 30 %.

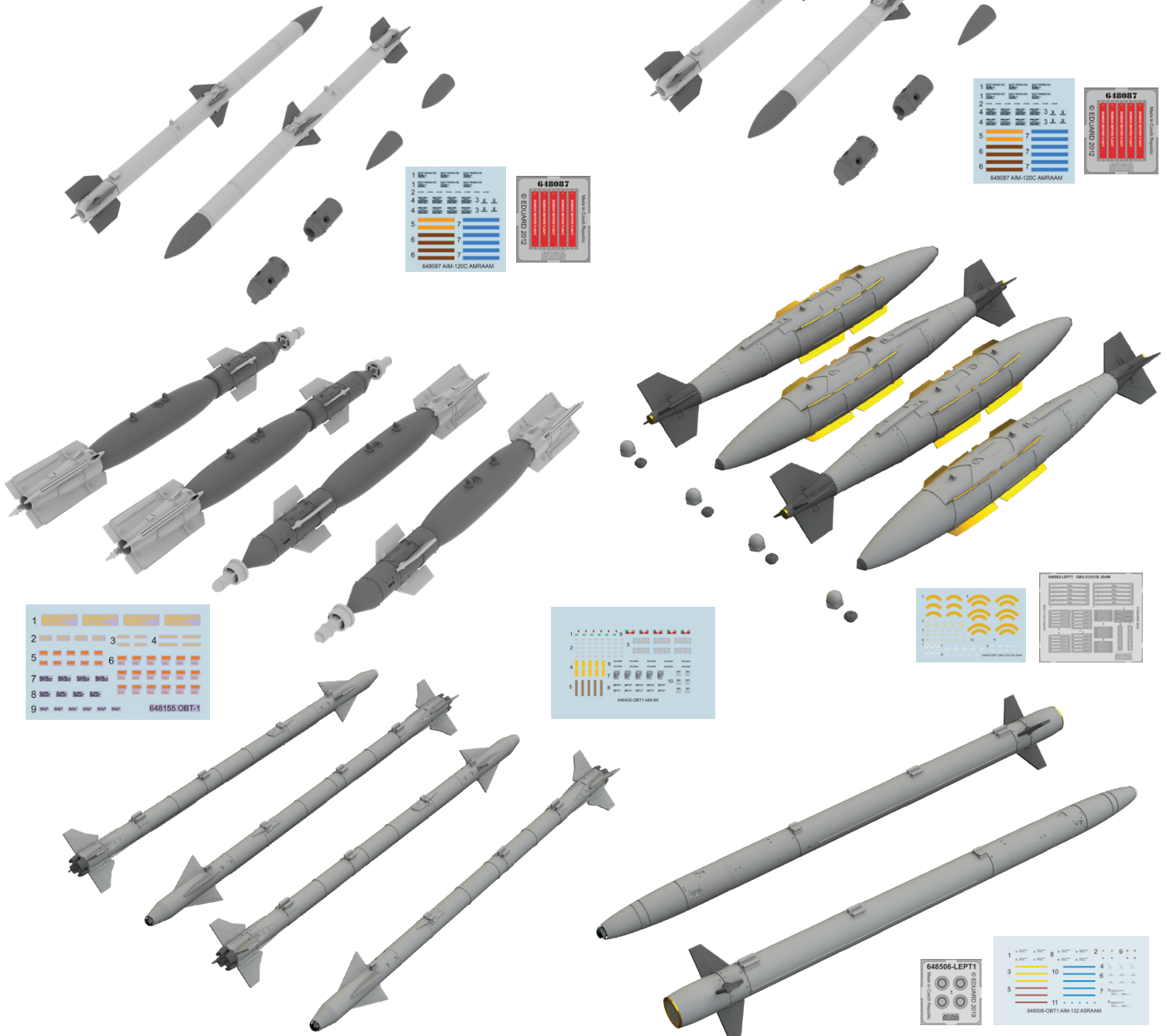

1/48



eduard

Avia B.534 IV.serie

ProfiPACK
edition

ProfiPACK edition kit of Czechoslovak fighter aircraft Avia B.534 IV. serie in 1/48 scale.

WILD CARDS 

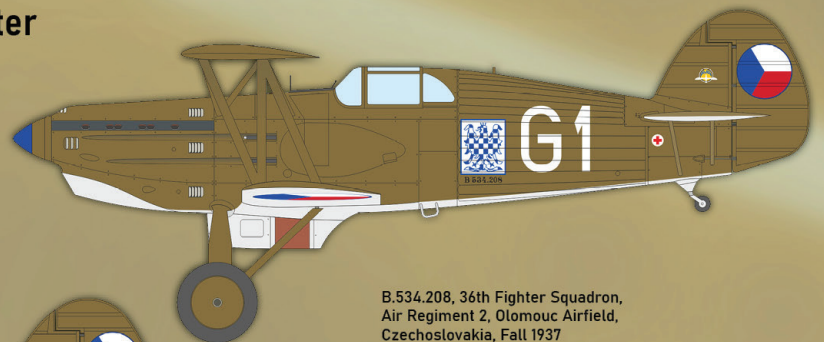

B.534.208, 36th Fighter Squadron,
Air Regiment 2, Olomouc Airfield,
Czechoslovakia, Fall 1937

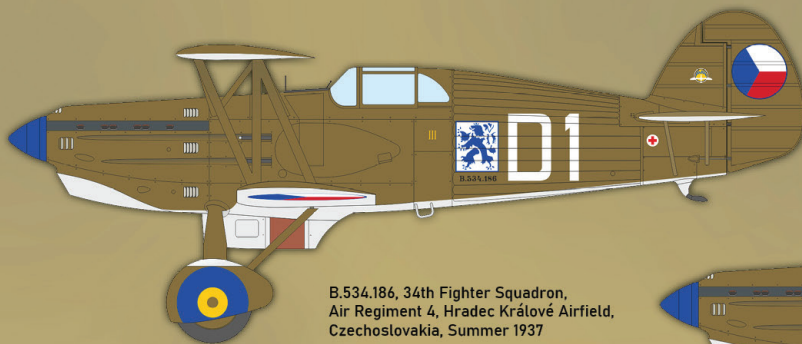

B.534.186, 34th Fighter Squadron,
Air Regiment 4, Hradec Králové Airfield,
Czechoslovakia, Summer 1937

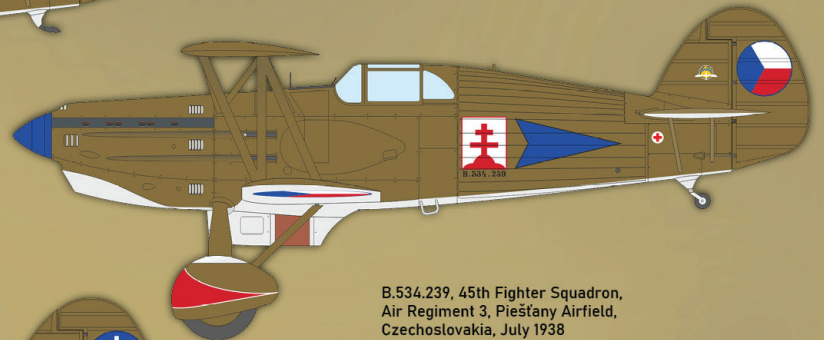

B.534.239, 45th Fighter Squadron,
Air Regiment 3, Piešťany Airfield,
Czechoslovakia, July 1938



B.534.217, Combined Squadron of Slovak National Uprising,
Tri Duby Airfield, Slovakia, September 1944

#8192

www.eduard.com

3D printed AFV & diorama solution

- 635017 WWII German clamps Type 1 PRINT (Brassin)
- 635018 WWII German hammer PRINT (Brassin)
- 635019 WWII German axe PRINT (Brassin)
- 635020 MG 34 gun w/ammunition belt PRINT (Brassin)
- 635021 WWII German clamps Type 2 PRINT (Brassin)
- 635022 WWII German NOTEK rear lights PRINT (Brassin)
- 635023 WWII German NOTEK headlights PRINT (Brassin)
- 635025 WWII German shovels PRINT (Brassin)

Cat. No. 635018



Cat. No. 635019

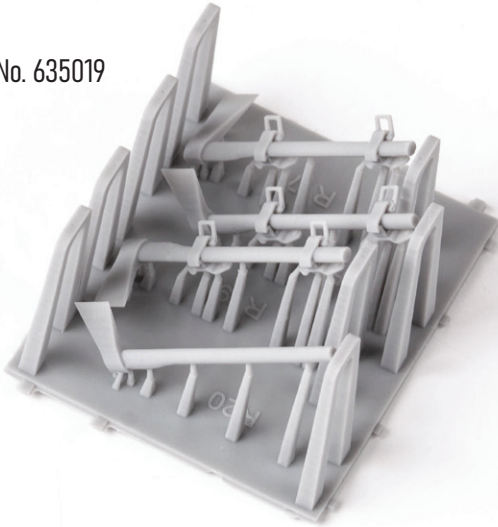

Cat. No. 635020

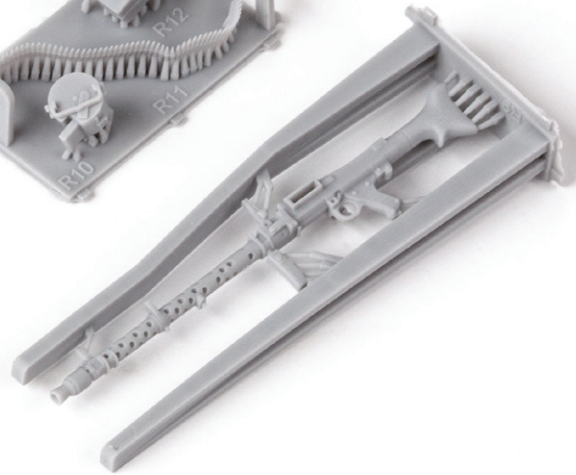
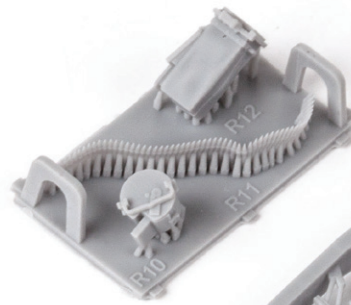

Cat. No. 635022

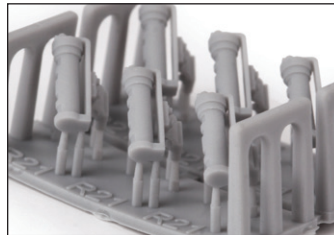
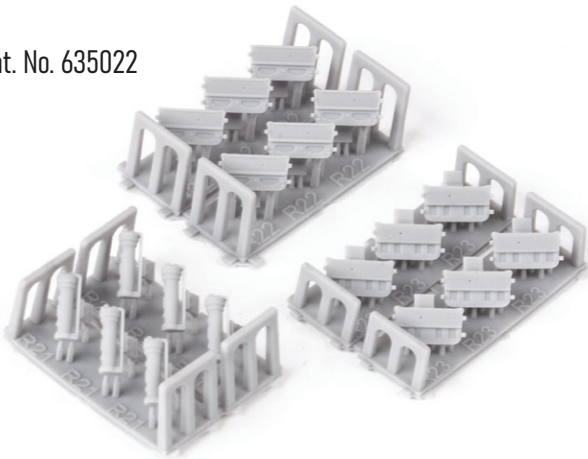

Cat. No. 635017

Eduard goodies for B-24D

1/48 Revell

- 481102 B-24D exterior (PE-Set)
- 491338 B-24D cockpit (PE-Set)
- 491339 B-24D nose interior (PE-Set)
- FE1338 B-24D (PE-Set)
- FE1339 B-24D seatbelts STEEL (PE-Set)
- 3DL48111 B-25J glazed nose SPACE (3D Decal Set)
- EX927 B-24D TFace (Mask)

Cat. No. EX927

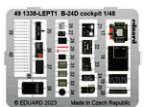
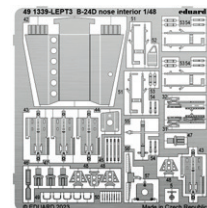
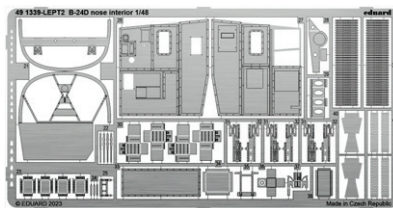
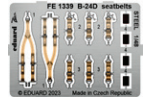
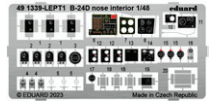
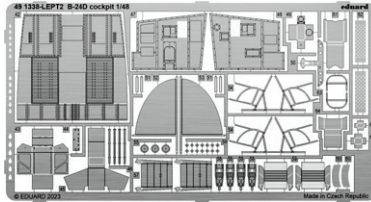
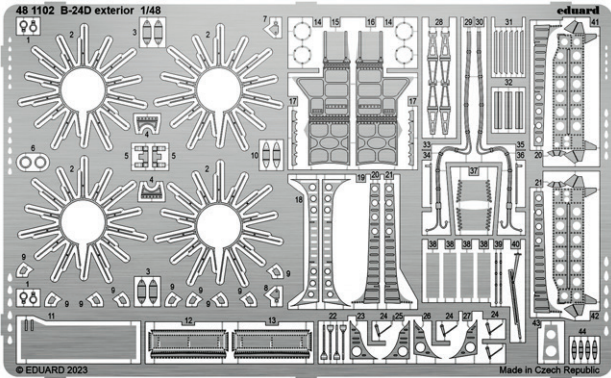
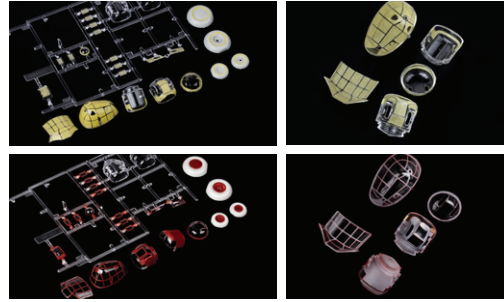

Eduard goodies for Anson Mk.I

1/48 Airfix

- 481099 Anson Mk.I landing flaps (PE-Set)
- 481100 Anson Mk.I bomb bays (PE-Set)
- 491326 Anson Mk.I (PE-Set)
- FE1326 Anson Mk.I (PE-Set)
- FE1327 Anson Mk.I seatbelts STEEL (PE-Set)
- 644202 Anson Mk.I Löök (Brassin)
- 648835 Anson Mk.I wheels (Brassin)
- 648841 Anson Mk.I radiators PRINT (Brassin)
- 3DL48103 Anson Mk.I SPACE (3D Decal Set)
- EX917 Anson Mk.I (Mask)
- EX918 Anson Mk.I TFace (Mask)

Cat. No. 644202

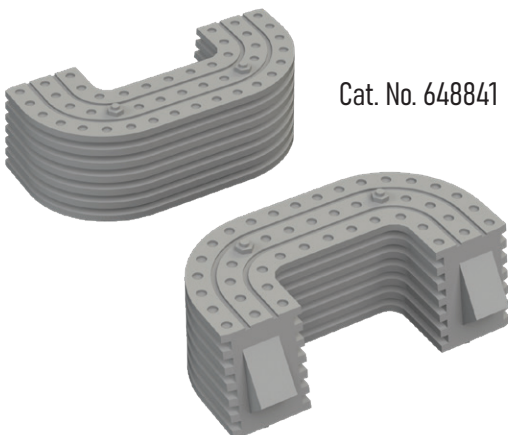
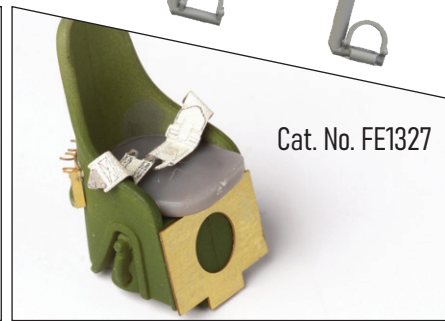
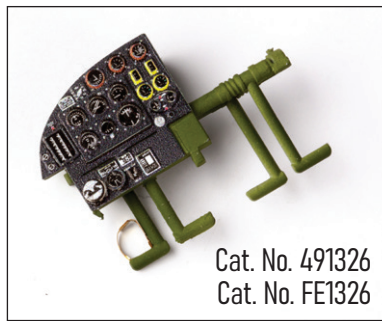
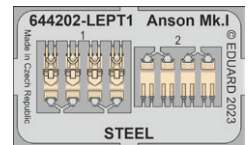

Cat. No. 648841

Cat. No. 491326
Cat. No. FE1326

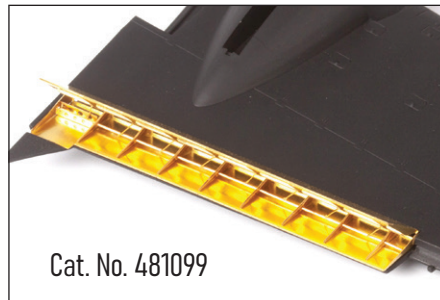

Cat. No. 481099



Cat. No. 481100

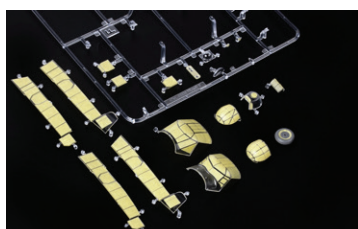

Cat. Nos EX917+EX918

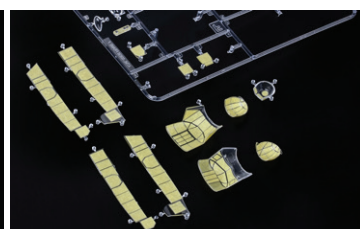

Cat. No. EX918

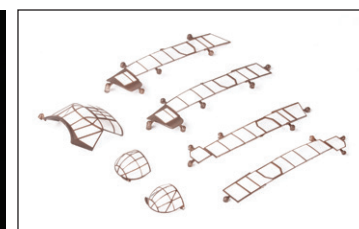

Cat. Nos EX917+EX918

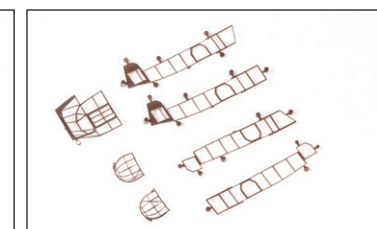

Cat. No. EX918