

MARCH 2023



Dear friends,
In today's Leaflet you will find the upcoming releases for March 2023.

THE KITS

In March we will release four new kits as new items and two more that were released earlier and not available for some time.

The biggest hit of the March kits will be probably the Guadalcanal Dual Combo in 1/48 scale in the Limited series. It will include parts for two F4F-4 Wildcat models, an early and a late one. The decals will offer the opportunity to build any of the twelve US Navy and US Marine Corps machines that we have selected from the period of the Guadalcanal fighting, which took place from August 1942 to the middle of the following year. Among them will be the legendary machine with which „Pug“ Southerland fought Saburó Sakai, of course Joe Foss, „Cash“ Register and many others.

In 1/48 scale in ProfiPACK edition we will release Spitfire Mk.Vc TROP. The kit will feature the famous Mk.Vc Spitfires modified for service in the North African dusty environment. The kit will enable to build Spitfires serving in the RAF, SAAF, USAAF and RAAF. The decals will offer the opportunity to build a model of one of six desert Spits from North Africa, Malta, the Pacific and also one Yugoslavian.

In 1/72 scale we will offer two items that focus on the history of the Luftwaffe. The first one will be in the ProfiPACK Bf 109E-4 edition (Special Hobby). The cover will depict one of Adolf Galland's last battles in the late 1940. The kit will offer decals for six aircraft, one of which is from the fighting in France in the spring of 1940, four are documented from the Battle of Britain and one in tropical camouflage was documented at the start of the fighting on the Eastern Front.

The other new addition to the Weekend line will be the Bf 110G-2. For this series we have been offering decals for four machines for some time. This new release will be no exception. The kit will be offer decals to build fighters that flew in Western Europe in 1943, in the Mediterranean, as night fighters on the Eastern Front, or with the 37mm gun mounted under the fuselage in the Defence of the Reich.

In this re-release we will bring back to the range two kits in the ProfiPACK series in 1/48 scale that were not available for some time. This will be the MiG-21bis, which will feature decals for six machines - Bulgarian, Hungarian, Polish, Finnish, Croatian and Indian. The second reissue will be the iconic Avia B.534 Series IV, which will be used to build one of the three pre-war aircraft of the Czechoslovak Air Force, or the Avia that served in 1944 with the Slovak Resistance Air Force.

DECAL SETS

We will release 1/48 scale stencil decals for B-25J (HKM) and first sheet of stencil decals for Su-25 (Zvezda). In this large sheet will be covered the Russian stencils. Similar sets in Czech and Slovak language will follow.

BRASSIN

Most of the new products in the Brassin range have been produced by direct 3D printing for many months now, and March will be no different. It's good to know that sales of Brassin range printed kits conti-

nue to grow, so at the end of last year we installed two more 3D printers to better and more flexibly meet the growing demand.

We will be releasing sets with the engine and landing gear wells for the F4F-4 Wildcat in 1/48 scale (Eduard).

For the 1/48 scale F-35A (Tamiya) kit, we will continue with the undercarriage wheels as well as the LööK set. We will also release an armament set for this kit in the BigSin edition.

We will release landing gear wheels and radiator set for Anson Mk.I (Airfix) in 1/48 scale.

We will produce the machine gun set and LööK set for Beaufort Mk.I kit (ICM) in 1/48 scale.

We have already released several sets for Arma Hobby's P-39Q in 1/72 scale, and we will continue in March with a bomb and an additional tank, including ranks.

We will release a set of ejection seats in 1/48 scale for the F-16 (Kinetic). We will release the handles for the above seats as a separate set, they will be painted on both sides and should save modelers time and trouble.

The 1/48 scale a set of the black cockpit for the Mi-24/35 (Zvezda) will include the 3D Space decals.

We will also release the LööK kit in black color.

In the BigSin edition we will also release the ESSENTIAL set in 1/48 scale for Fw 190A-8 (Eduard) by direct 3D printing. It will include also cockpit and flap parts.

We will continue with in the 1/35 scale sets with generic accessories for WW2 German vehicles. These will be the front notek lights and the shovels.

SPACE

We have eight new products in the Space range. Where appropriate from a modelling point of view, we combine our 3D decals in the Space sets with photo etched parts. In 1/32 scale this will be a set for Hurricane Mk.IIb (Revell). In 1/24 scale we will release set for the Spitfire Mk.IXc (Airfix) and in 1/48 scale we will produce five sets including the F-35A (Tamiya), also one for the new Mi-8MT (Zvezda) and last but not least, Avia B.534 IV. series.

MASKS

I don't usually mention masks in this editorial, but I would like to mention one set in connection with the March items. This is a set of RAM panels, again for the F-35A Tamiya kit. It's an unusually large set, used to mask the outlines of the RAM panels on the surface of JASDF and USAF machines. The set offers a total of eight decal options. A similar, only significantly smaller set of masks for these panels for the remaining seven machines in this Tamiya kit can be found among the February releases just being released. These mask sets are made of a different film than the film used for the canopy mask sets. In addition to its properties that make it more suitable for these surface masks, this material also differs in its black color. With these two items, we return to masks for spraying camouflage fields, emblems and marking details after a long break. We will continue to release similar masks, mainly for our own kits.

Photo-etched parts

The smaller 1/48th scale photo etched sets for the F-35A (Tamiya), which we are now launching as part of the February news block, will be followed up in

March with a large set of photo etched accessories. For the new 1/48 scale B-25J glazed nose kit (HKM) we will release a Zoom set, steelbelts, a large photo etched set and a separate set for the bomb bay.

For Revell's aforementioned new release, the Hurricane Mk.IIb (1/32), we will release the usual photo etched set and landing flaps set.

We are also releasing a photo etched set in March for the new 1/48 scale F-16A MLU (Kinetic). This is a follow up to the sets we released for the F-16C Block 25/42.

For the new Spitfire Mk.IXc in 1/24 scale from Airfix we will release in March steelbelts, a set for the interior and some details for the exterior. We will follow up in April with two more sets that will include details for the engine and gun bays.

For the C-130J kit in 1/72 scale (Zvezda) we will release a series of photo etched sets covering basically the entire model.

Revell has returned to 1/48 scale the B-24D that was originally released in the Monogram production program. We still have two sets for sale, and we will be returning the ones that were discontinued in the past to sale in an updated and revised form. We are still considering a set for the bomb bay.

With the re-release of the Bf 110G-2 (Eduard, 1/72) we will put back on sale both the Zoom set and the larger unpainted set and of course the masks.

Also for the MiG-21bis (Eduard, 1/48), the unpainted updated photo etched set will be on sale.

With the third set of photo etched parts we continue with the accessories for the USS Alaska CB-1 in 1/350 scale kit from Hobby Boss.

Orders and prices

We would welcome your pre-orders for March items by Wednesday, February 1, 2023.

I would like to point out that due to the situation where there is a noticeable drop in sales especially for accessories, we are putting into production volumes consistently based on the total number of pre-orders for each item produced. The quantities that create a reserve for customers without pre-orders are significantly reduced in production and are largely produced only according to the requirements resulting from actual orders. Therefore, if you do not have pre-orders, your new orders may be delayed. This is a situation we have long warned against. In the boom times, this was rarely the case, but the current situation is different and forces us to rationalize our procedures. Thank you for your understanding and cooperation!

February items will be ready for shipping on Wednesday, 18 January.

We are also sending folder with the graphics included in the Leaflet. Many of you are using our Leaflet images for pre-order section of your e-shops and in your newsletters. We hope this will save you some time.

If you would like get more information, clarify some points or if you would need our help, please contact us at department@eduard.cz or contact me directly at jan.bobek@eduard.cz

We look forward to meeting some of you at the Nuremberg Fair.

You will find us in Hall H7A at stand E-14.

Jan Bobek

Product previews are subject of change.

Instruction sheets,
more pictures and information
can be found on www.eduard.com

This leaflet can be downloaded from on www.eduard.com

PLASTIC KITS



82126 **Spitfire Mk.Vc TROP**
1/48 ProfiPACK

DETAIL



7033 **Bf 109E-4**
1/72 ProfiPACK

DETAIL



11170 **GUADALCANAL**
1/48 LIMITED **DUAL COMBO**

DETAIL



7468 **Bf 110G-2**
1/72 Weekend edition

DETAIL



8192 **Avia B.534 IV serie**
1/48 ProfiPACK **Re-release**

DETAIL



8232 **MiG-21bis**
1/48 ProfiPACK **Re-release**

DETAIL

MASKS

LX007	Spitfire Mk.IXc	1/24	Airfix
LX008	Spitfire Mk.IXc TFace	1/24	Airfix
JX305	Hurricane Mk.IIb	1/32	Revell
JX306	Hurricane Mk.IIb TFace	1/32	Revell
EX925	B-25J glazed nose	1/48	HKM
EX926	B-25J glazed nose TFace	1/48	HKM
EX927	B-24D TFace	1/48	Revell
EX928	B.534 IV. serie TFace	1/48	Eduard
EX929	F-16A MLU	1/48	Kinetic
EX930	F-16A MLU TFace	1/48	Kinetic
EX931	F-35A RAM coating early	1/48	Tamiya
EX932	Mi-8MT	1/48	Zvezda
EX933	Mi-8MT TFace	1/48	Zvezda
CX643	C-130J	1/72	Zvezda
CX644	Bf 110G-2	1/72	Eduard

SPACE

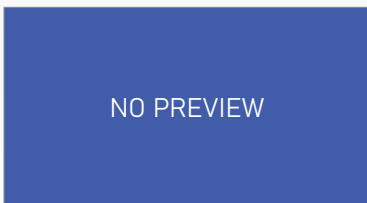

3DL32012 Hurricane Mk.IIb SPACE
1/32 Revell
(2 parts)

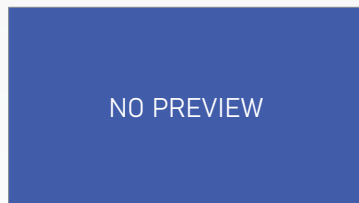

3DL32013 Spitfire Mk.IXc SPACE
1/24 Airfix
(2 parts)

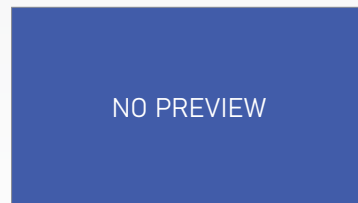

3DL48107 F-16A MLU SPACE
1/48 Kinetic
(2 parts)

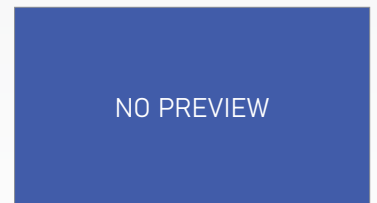

3DL48108 B.534 IV. serie SPACE
1/48 Eduard
(2 parts)

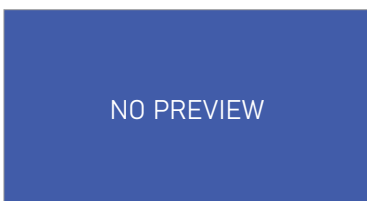

3DL48109 F-35A SPACE
1/48 Tamiya
(2 parts)

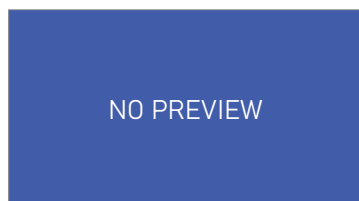

3DL48110 B-24D SPACE
1/48 Revell
(2 parts)

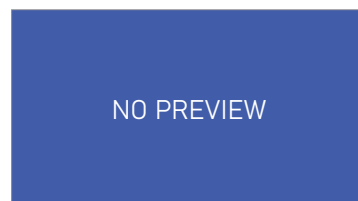

3DL48111 B-25J glazed nose SPACE
1/48 HKM
(2 parts)

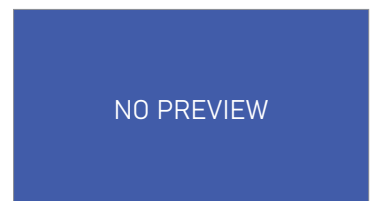

3DL48112 Mi-8MT SPACE
1/48 Zvezda
(2 parts)

PHOTO-ETCHED SETS

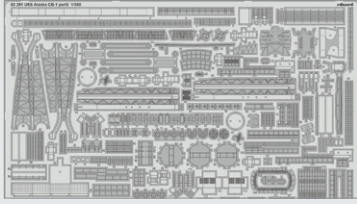

53291 USS Alaska CB-1 part 3
1/350 Hobby Boss
(1 part)

[DETAIL](#)

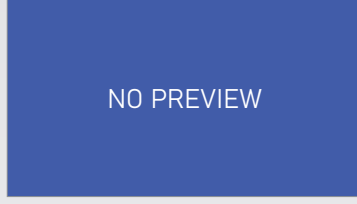

23036 Spitfire Mk.IXc
1/24 Airfix
(1 part)

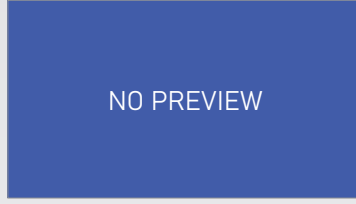

23037 Spitfire Mk.IXc
1/24 Airfix
(1 part)



32481 Hurricane Mk.IIb landing flaps
1/32 Revell
(1 part)

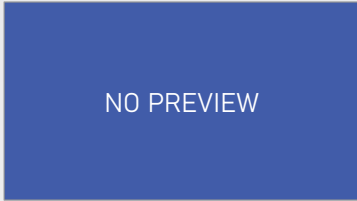

321006 Hurricane Mk.IIb
1/32 Revell
(1 part)

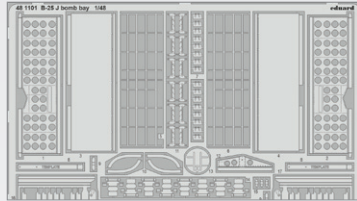

481101 B-25J bomb bay
1/48 HKM
(1 part)

[DETAIL](#)

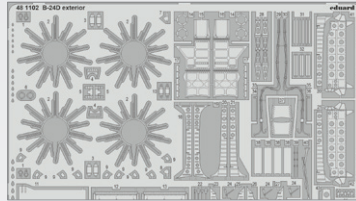

481102 B-24D exterior
1/48 Revell
(1 part)

[DETAIL](#)



481103 MiG-21bis exterior
1/48 Eduard
(1 part)

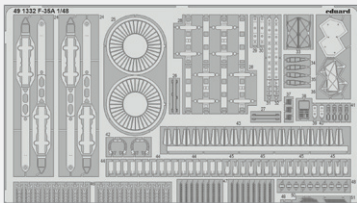

491332 F-35A
1/48 Tamiya
(1 part)

[DETAIL](#)

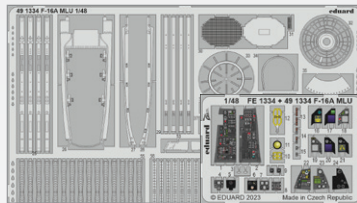

491334 F-16A MLU
1/48 Kinetic
(2 parts)

[DETAIL](#)

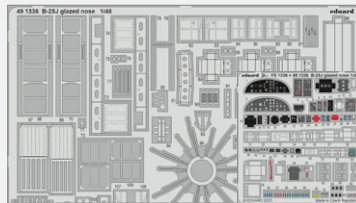

491336 B-25J glazed nose
1/48 HKM
(2 parts)

[DETAIL](#)

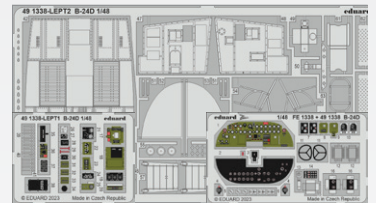

491338 B-24D cockpit
1/48 Revell
(3 parts)

[DETAIL](#)

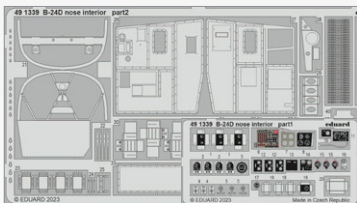

491339 B-24D nose interior part2
1/48 Revell
(2 parts)

[DETAIL](#)

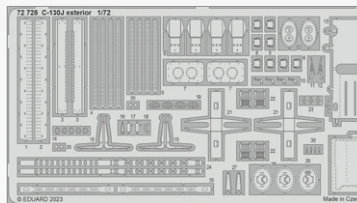

72728 C-130J exterior
1/72 Zvezda
(1 part)

[DETAIL](#)

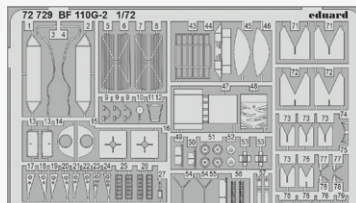

72729 Bf 110G-2
1/72 Eduard
(1 part)

[DETAIL](#)

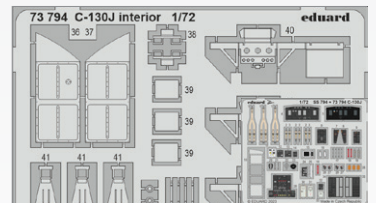

73794 C-130J interior
1/72 Zvezda
(2 parts)

[DETAIL](#)

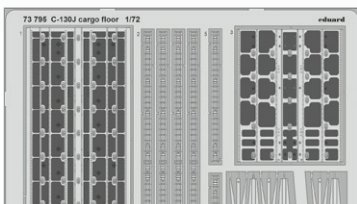

73795 C-130J cargo floor
1/72 Zvezda
(1 part)

[DETAIL](#)

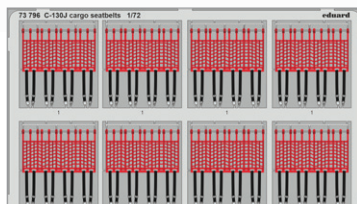

73796 C-130J cargo seatbelts
1/72 Zvezda
(1 part)

[DETAIL](#)

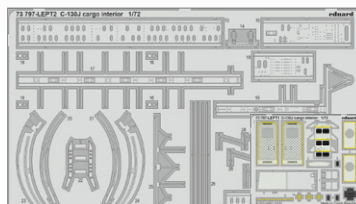

73797 C-130J cargo interior
1/72 Zvezda
(2 parts)

[DETAIL](#)

PHOTO-ETCHED SETS

ZOOM

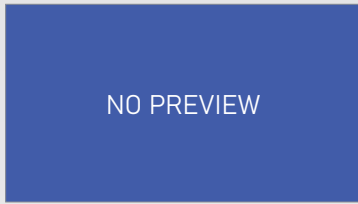

33343 Hurricane Mk.IIb
1/32 Revell
(1 part)

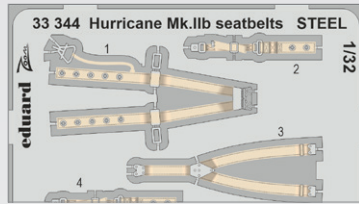

33344 Hurricane Mk.IIb seatbelts
STEEL 1/32 Revell
(1 part)

DETAIL

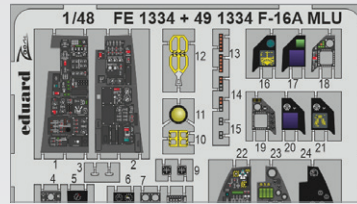

FE1334 F-16A MLU
1/48 Kinetic
(1 part)

DETAIL

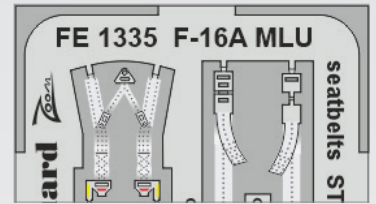

FE1335 F-16A MLU seatbelts STEEL
1/48 Kinetic
(1 part)

DETAIL

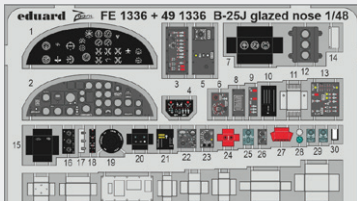

FE1336 B-25J glazed nose
1/48 HKM
(1 part)

DETAIL

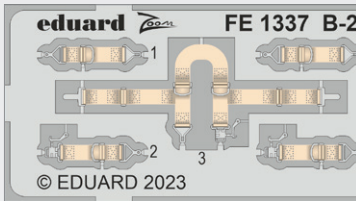

FE1337 B-25J glazed nose
seatbelts STEEL 1/48 HKM
(1 part)

DETAIL

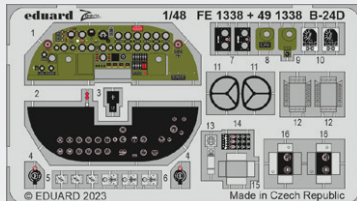

FE1338 B-24D
1/48 Revell
(1 part)

DETAIL

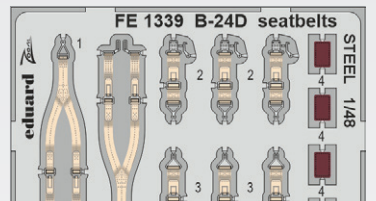

FE1339 B-24D seatbelts STEEL
1/48 Revell
(1 part)

DETAIL

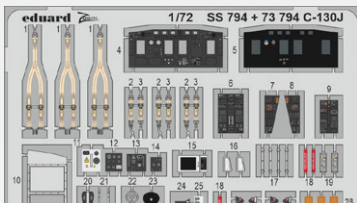

SS794 C-130J
1/72 Zvezda
(1 part)

DETAIL

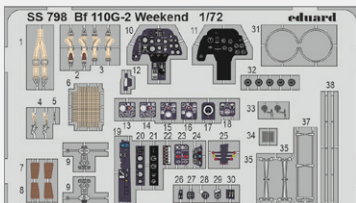

SS798 Bf 110G-2 Weekend
1/72 Eduard
(1 part)

DETAIL

BIG ED SETS

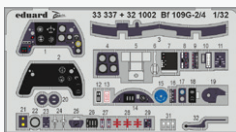

BIG33148 Bf 109G-2/4
1/32 Revell

DETAIL

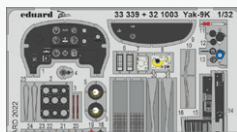

BIG33149 Yak-9K
1/32 ICM

DETAIL



BIG49359 Mi-4
1/48 Trumpeter

DETAIL

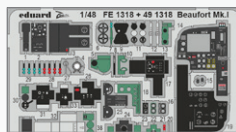

BIG49360 Beaufort Mk.I
PART I 1/48 ICM

DETAIL

DECAL SETS

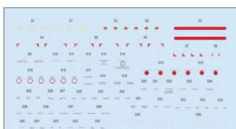

D48110 B-25J stencils
1/48 HKM

DETAIL

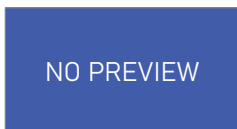

D48111 Su-25 Russian
stencils 1/48 Zvezda

BRASSIN



644201 Mi-24V black (Mi-35) **Löök** 1/48 Eduard/Zvezda

DETAIL

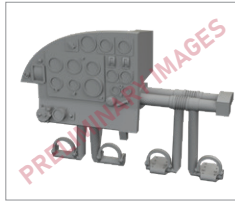

644202 Anson Mk.I **Löök** 1/48 Airfix

DETAIL

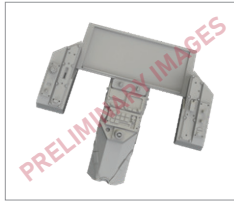

644203 F-35A **Löök** 1/48 Tamiya

DETAIL



635023 WWII German NOTEK headlights **PRINT** 1/35

DETAIL

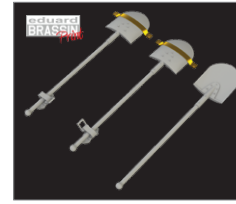

635025 WWII German shovels **PRINT** 1/35

DETAIL

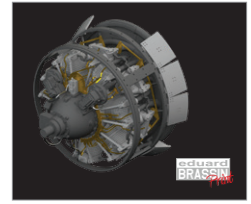

648828 F4F-4 engine **PRINT** 1/48 Eduard

DETAIL

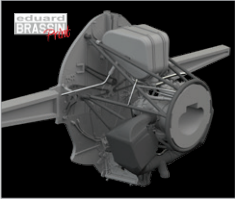

648829 F4F-4 wheel bay **PRINT** 1/48 Eduard

DETAIL



648835 Anson Mk.I wheels 1/48 Airfix

DETAIL



648836 ACES II ejection seat lower handles **PRINT** 1/48

DETAIL



648837 F-16 ejection seat **PRINT** 1/48 Kinetic

DETAIL

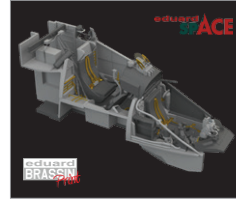

648838 Mi-24V cockpit black (Mi-35) **PRINT** & **SPACE** 1/48 Eduard/Zvezda

DETAIL



648839 F-35A wheels 1/48 Tamiya

DETAIL

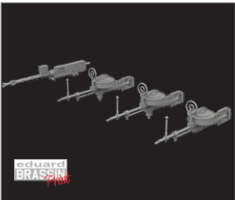

648840 Beaufort Mk.I guns **PRINT** 1/48 ICM

DETAIL

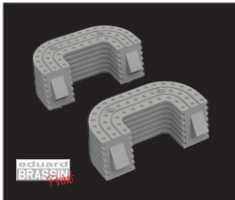

648841 Anson Mk.I radiators **PRINT** 1/48 Airfix

DETAIL

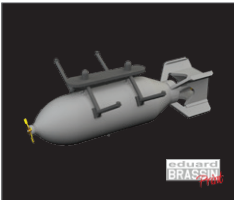

672308 P-39Q 500lb bomb **PRINT** 1/72 Arma Hobby

DETAIL



672309 P-39Q 75gal drop tank **PRINT** 1/72 Arma Hobby

DETAIL

Löökplus

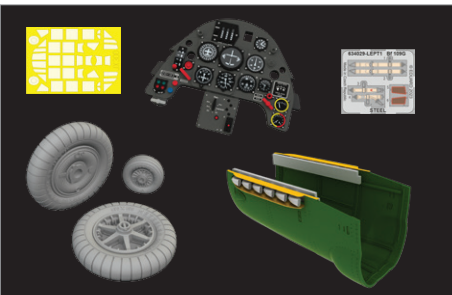

634031 Bf 109G-2 **Löökplus** 1/32 Revell

DETAIL

Löökplus

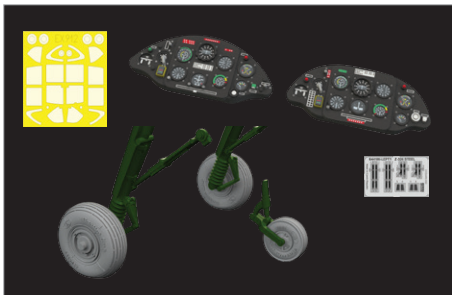

644197 Z-326 **Löökplus** 1/48 Eduard

DETAIL

Löökplus

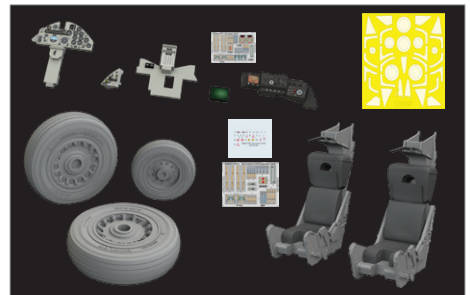

644199 Buccaneer S.2C/D **Löökplus** 1/48 Airfix

DETAIL

Löökplus

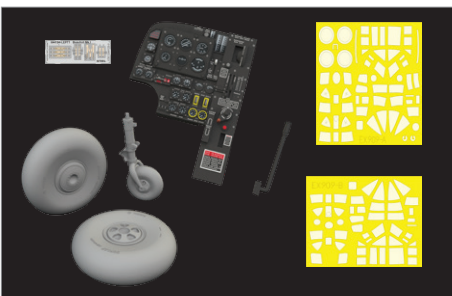

644200 Beaufort Mk.I **Löökplus** 1/48 ICM

DETAIL

BIGSIN



SIN648100 F-35A armament 1/48 Tamiya

DETAIL

BIGSIN

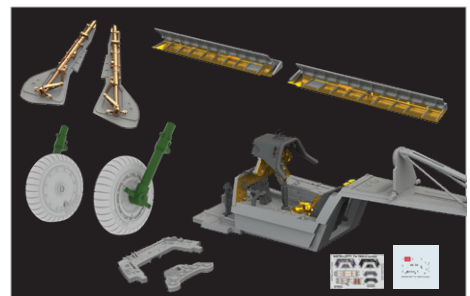

SIN648101 Fw 190A-8 **ESSENTIAL** 1/48 Eduard

DETAIL

ProfiPACK edition kit of British WWII fighter plane Spitfire Mk.Vc TROP in 1/48 scale. Kit presents tropical version of famous Spitfire Mk.Vc flying in the RAF, SAAF, USAAF and RAAF.

BASIC INFO:

NAME: **Spitfire Mk.Vc TROP**

CAT. NO.: 82126

SCALE: 1/48

EDITION: ProfiPACK

CONTENTS:

SPRUES: Eduard

PE-SETS: Yes, pre-painted

PAINTING MASK: Yes

MARKING OPTIONS: 6

BRASSIN: No

RELATED PRODUCTS:

481065 Spitfire Mk.V landing flaps (PE-Set)

FE1207 Spitfire Mk.V seatbelts STEEL (PE-Set)

644113 Spitfire Mk.V LööK (Brassin)

648098 Spitfire wheels - 5 spoke (Brassin)

648119 Spitfire wheels - 5 spoke, smooth tire (Brassin)

648663 Spitfire Mk.V cockpit (Brassin)

648664 Spitfire Mk.V wheels (Brassin)

648666 Spitfire Mk.Vc gun bays (Brassin)

648667 Spitfire Mk.V three-stacks exhausts rounded (Brassin)

648668 Spitfire Mk.V three-stacks exhausts fishtail (Brassin)

648669 Spitfire Mk.V six-stacks exhausts fishtail (Brassin)

648671 Spitfire Mk.Vc undercarriage legs BRONZE (Brassin)

648738 Spitfire Mk.V landing flaps PRINT (Brassin)

D48088 Spitfire Mk.V stencils (Decal)

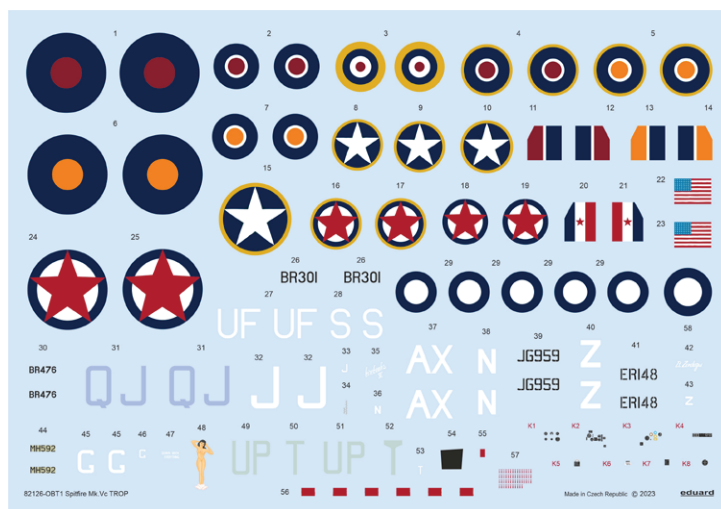
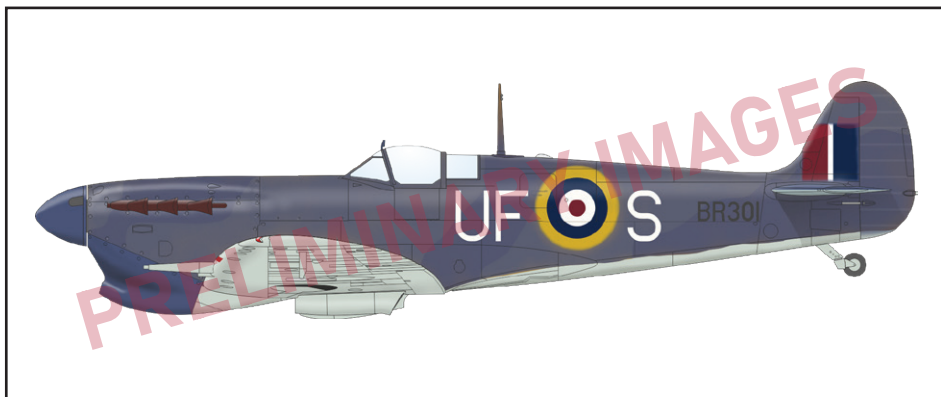

KIT PARTS

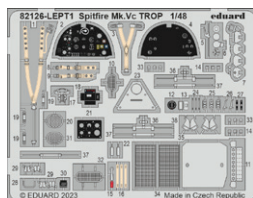
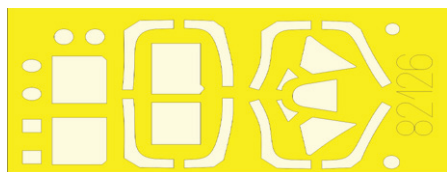
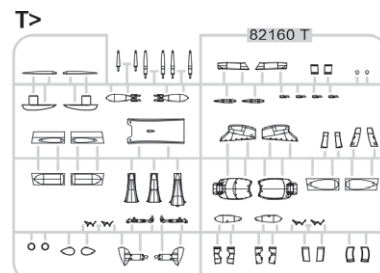
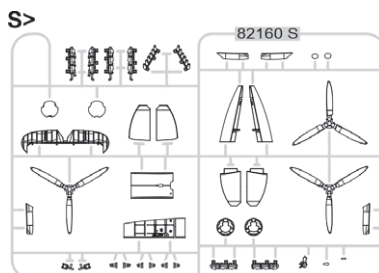
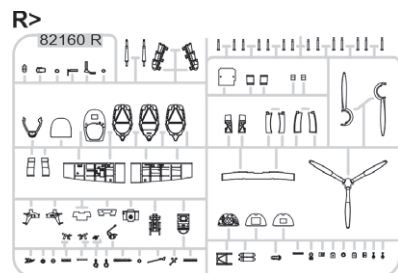
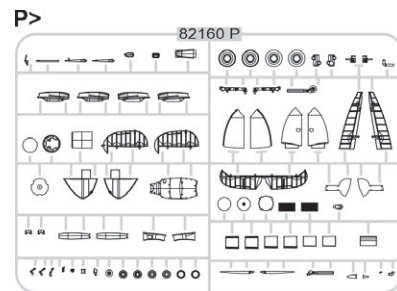
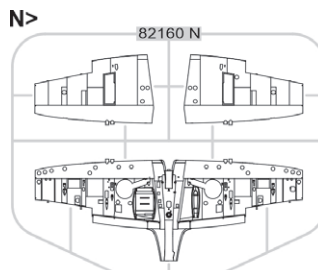
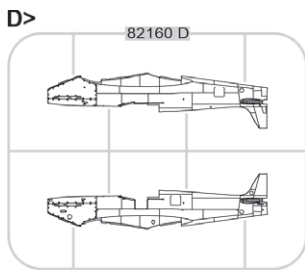
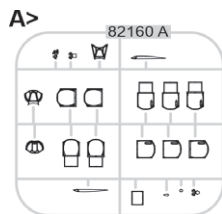

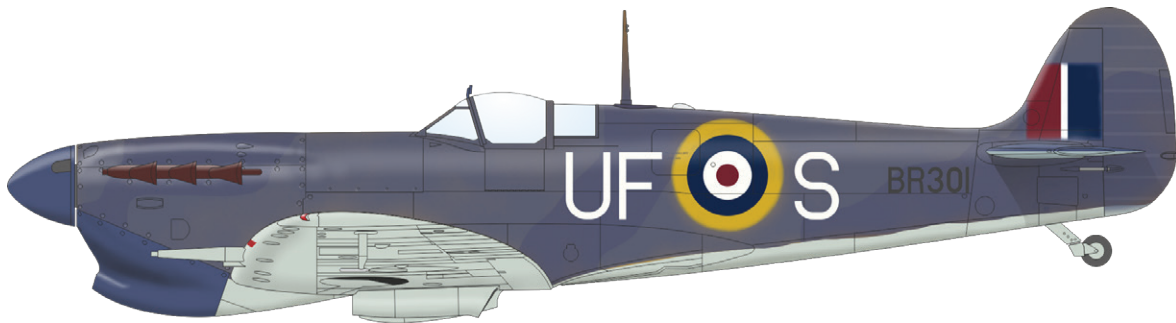

BR301, Sgt. George F. Beurling, No. 249 Squadron, RAF Hal Far, Malta, July 1942

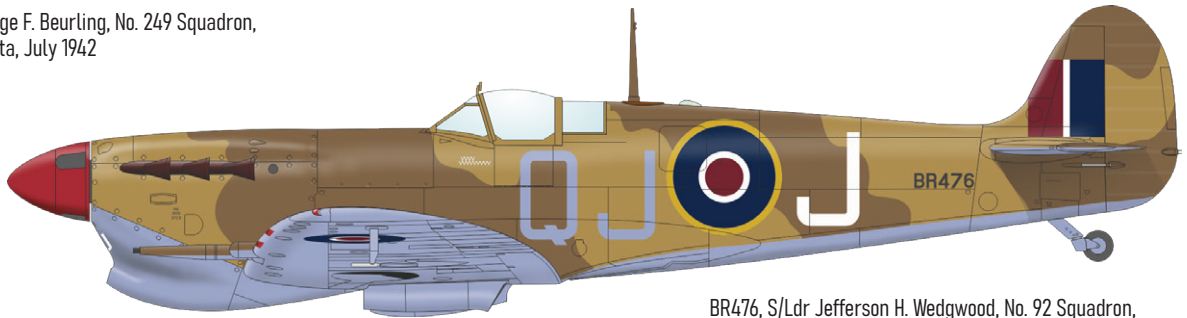

BR476, S/Ldr Jefferson H. Wedgwood, No. 92 Squadron, RAF LG. 173, Egypt, August–October 1942

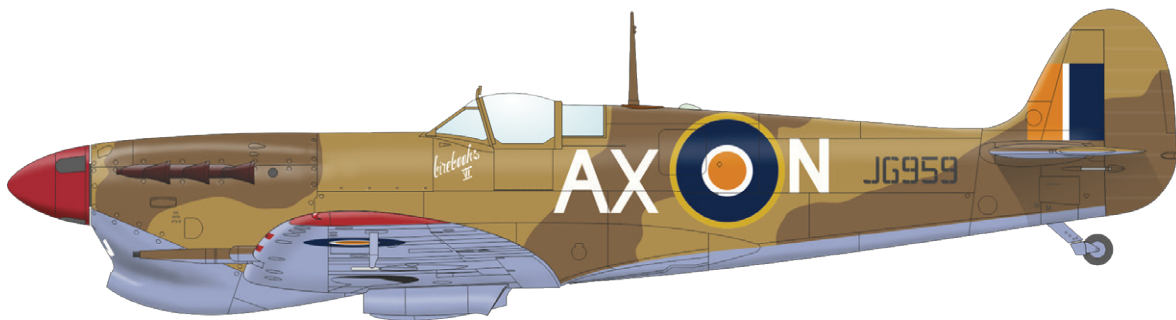

JG959, Lt. McClellan E. S. Robinson, No. 1 Squadron SAAF, Ben Gardane, Tunis, April 1943

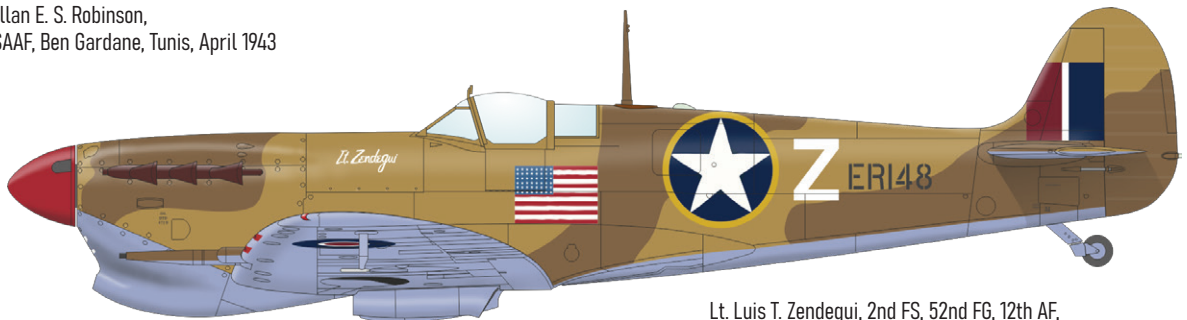

Lt. Luis T. Zendegui, 2nd FS, 52nd FG, 12th AF, La Sabala, Tunis, Winter 1942–1943

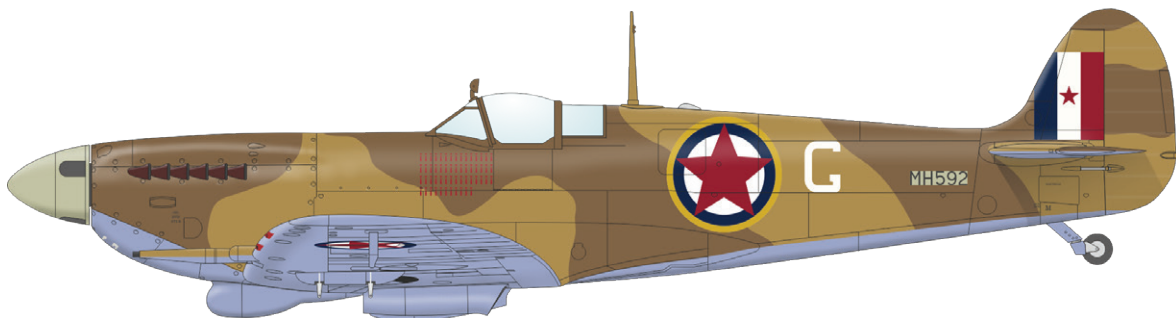

MH592, S/Ldr Hinko Šoič, NOVJ No. 352 (Yugoslav) Squadron, Vis, Yugoslav, January–February 1945

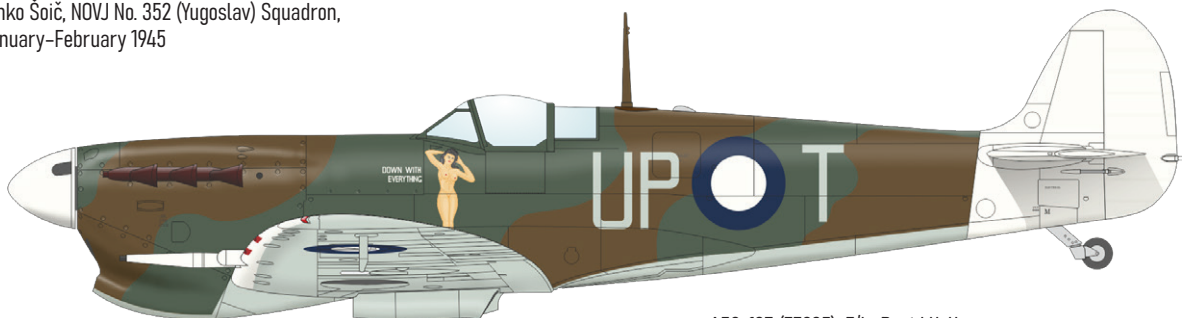

A58-137 (EE835), F/Lt David H. Hopton, No. 79 Squadron RAAF, Kiriwina, Trobriand Islands, October 1943

ProfiPACK edition kit of German WWII fighter plane Bf 109E-4 in 1/72 scale.

BASIC INFO:

NAME: **Bf 109E-4**

CAT. NO.: 7033

SCALE: 1/72

EDITION: ProfiPACK

CONTENTS:

SPRUES: Special Hobby

PE-SETS: Yes, pre-painted

PAINTING MASK: Yes

MARKING OPTIONS: 6

BRASSIN: No

RELATED PRODUCTS:

D72030 Bf 109E stencils (Decal Set)

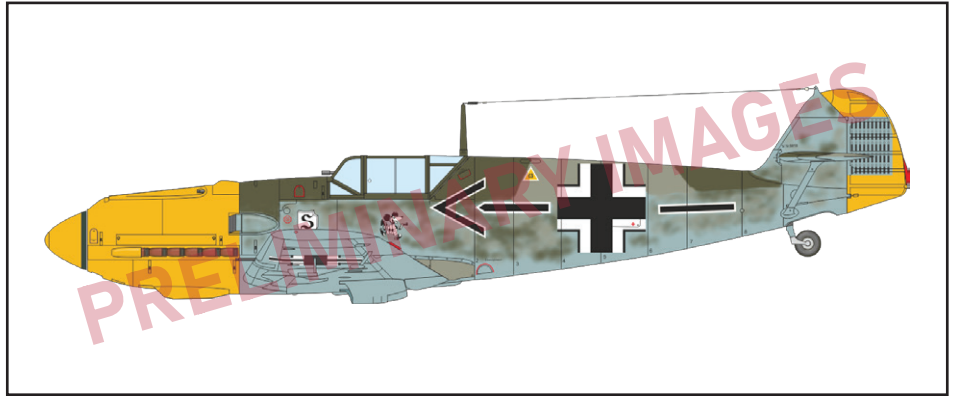

KIT PARTS

A>

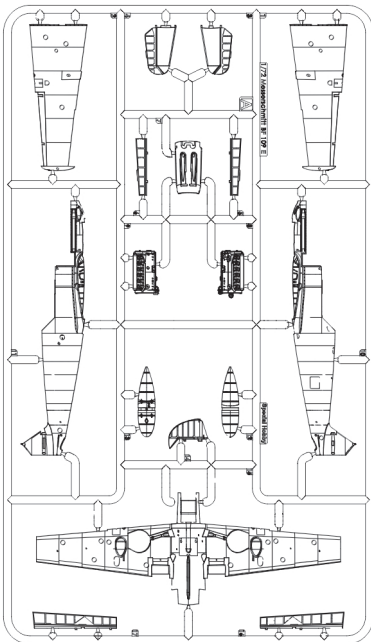

B>

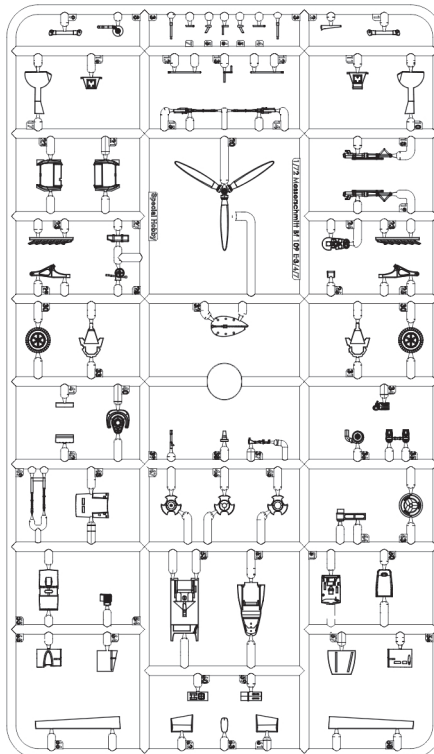

C>

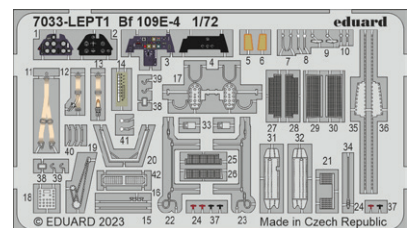
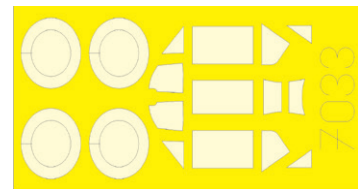
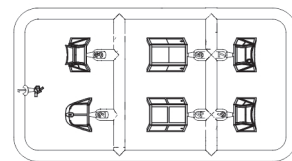

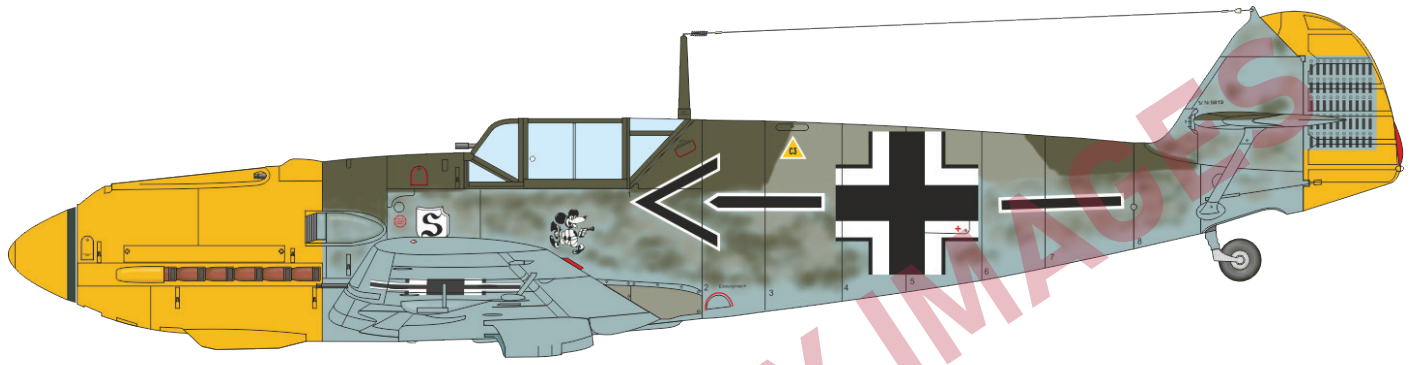

W.Nr. 5819, Obstlt. Adolf Galland, CO of JG 26, Audembert, France, October–December 1940

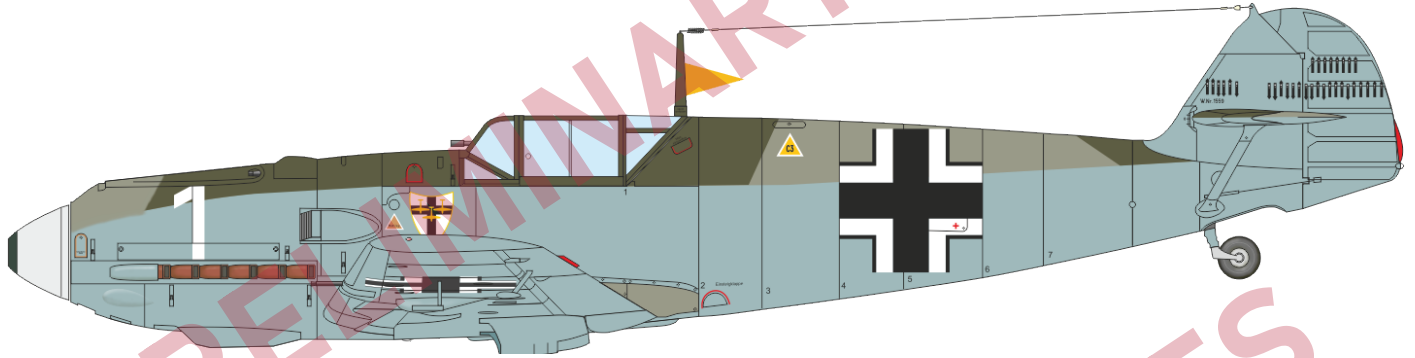

W.Nr. 1559, flown by Hptm. Wilhelm Balthasar, CO of 7./JG 27, Carquebut, France, July 1940

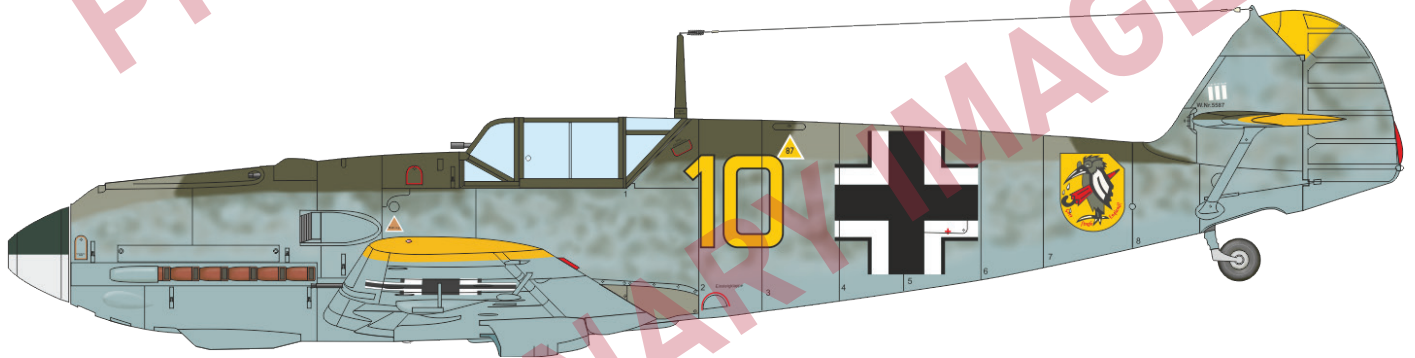

W.Nr. 5587, Ofw. Fritz Beeck, 6./JG 51, Wissant, France, August 1940

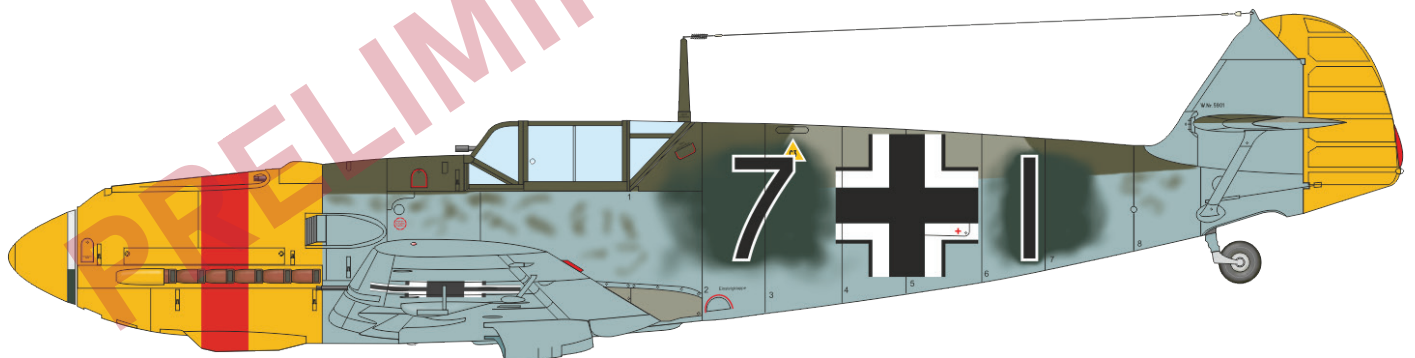

W.Nr. 5901, flown by Oblt. Walter Fiel, CO of 8./JG 53, Le Touquet-Etaples, France, September 1940

+ two more marking options

Lt. Josef Eberle, 9./JG 54, The Netherlands, August 1940

W.Nr. 2060, Lt. Hans Guse, 2.(J)/LG 2, Tudora, Soviet Union (today's Republic of Moldova), July 1941

Limited edition kit of US carrier based fighter F4F-4 Wildcat early and late production in 1/48 scale. Kit presents Wildcats from United States Navy and Marine Corps participating in the fighting for Guadalcanal.

DUAL COMBO

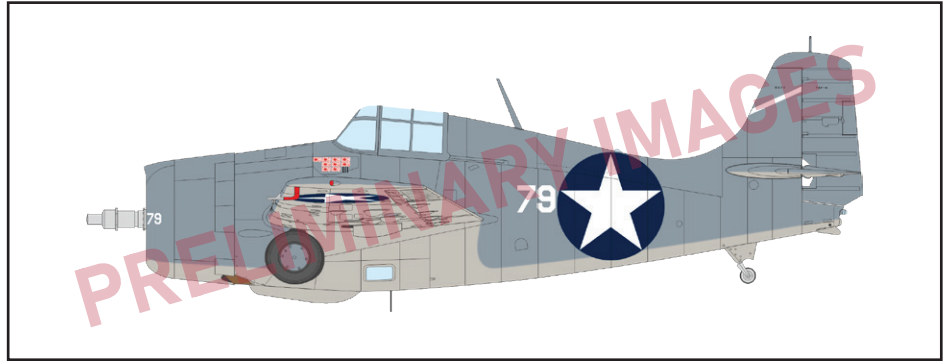

BASIC INFO:

NAME: **GUADALCANAL DUAL COMBO**

CAT. NO.: 11170

SCALE: 1/48

EDITION: LIMITED

CONTENTS:

SPRUES: Eduard

PE-SETS: Yes, pre-painted

PAINTING MASK: Yes

MARKING OPTIONS: 12

BRASSIN: No

RELATED PRODUCTS:

481093 F4F-4 landing flaps (PE-Set)

FE1290 F4F seatbelts STEEL (PE-Set)

644164 F4F-4 LööK (Brassin)

648756 F4F 42gal ventral drop tank PRINT (Brassin)

648769 F4F gun barrels PRINT (Brassin)

648779 F4F undercarriage legs BRONZE (Brassin)

648803 F4F-4 cockpit PRINT (Brassin)

648815 F4F-4 wheels early (Brassin)

648816 F4F-4 wheels late (Brassin)

648817 F4F-4 landing flaps PRINT (Brassin)

648818 F4F-4 folding wings PRINT (Brassin)

648820 F4F-4 exhausts PRINT (Brassin)

648828 F4F-4 engine PRINT (Brassin)

648829 F4F-4 wheel bay PRINT (Brassin)

3DL48090 F4F-4 SPACE (3D Decal Set)

EX904 F4F-4 TFace (Mask)

KIT PARTS

2x A>

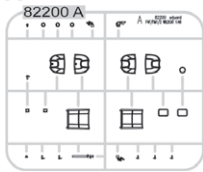

B>

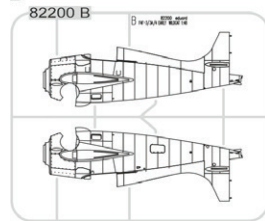

C>

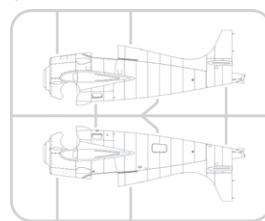

2x H>

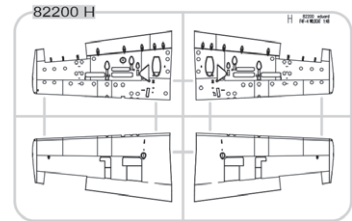

2x L>

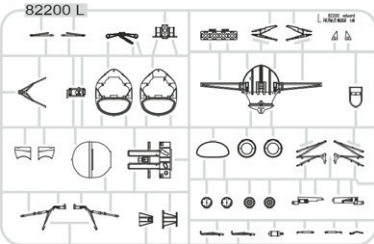

2x M>

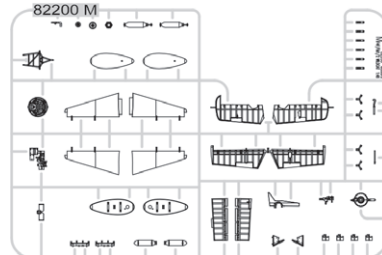

2x N>

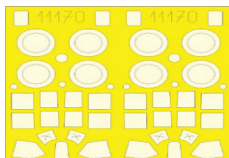
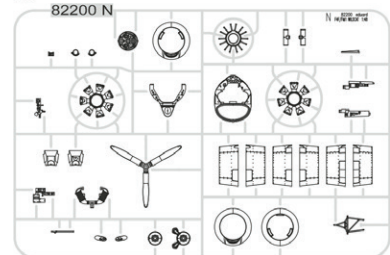

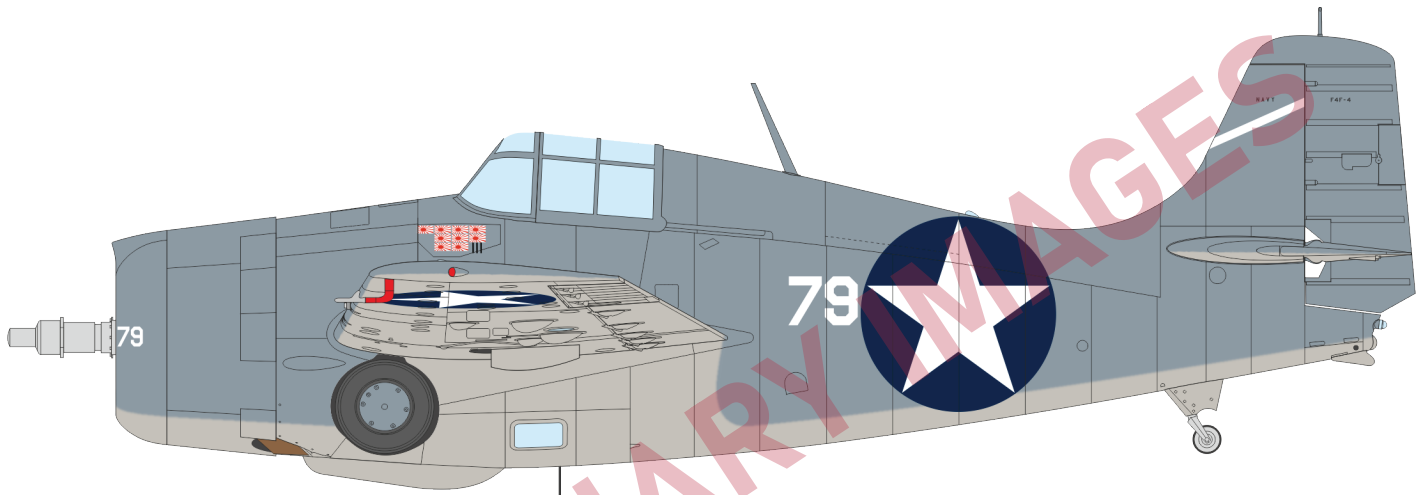

Lt. Stanley Vejtasa, VF-10, USS Enterprise, spring 1943

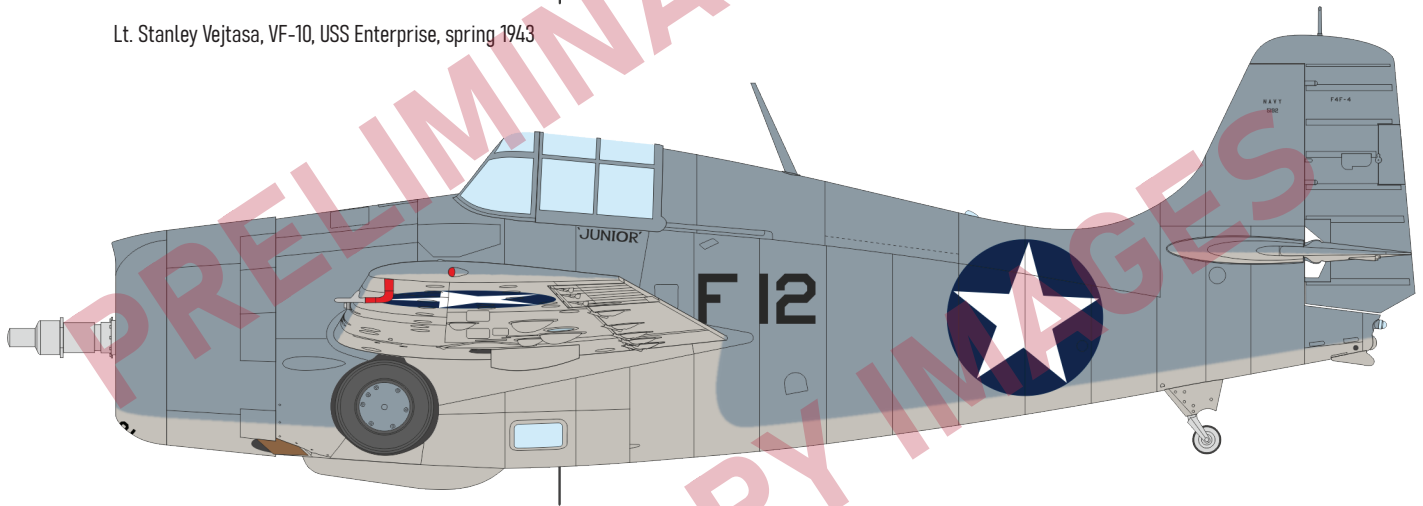

BuNo.5192 Lt. James „Pug“ Southerland, VF-5, USS Saratoga, August 7,

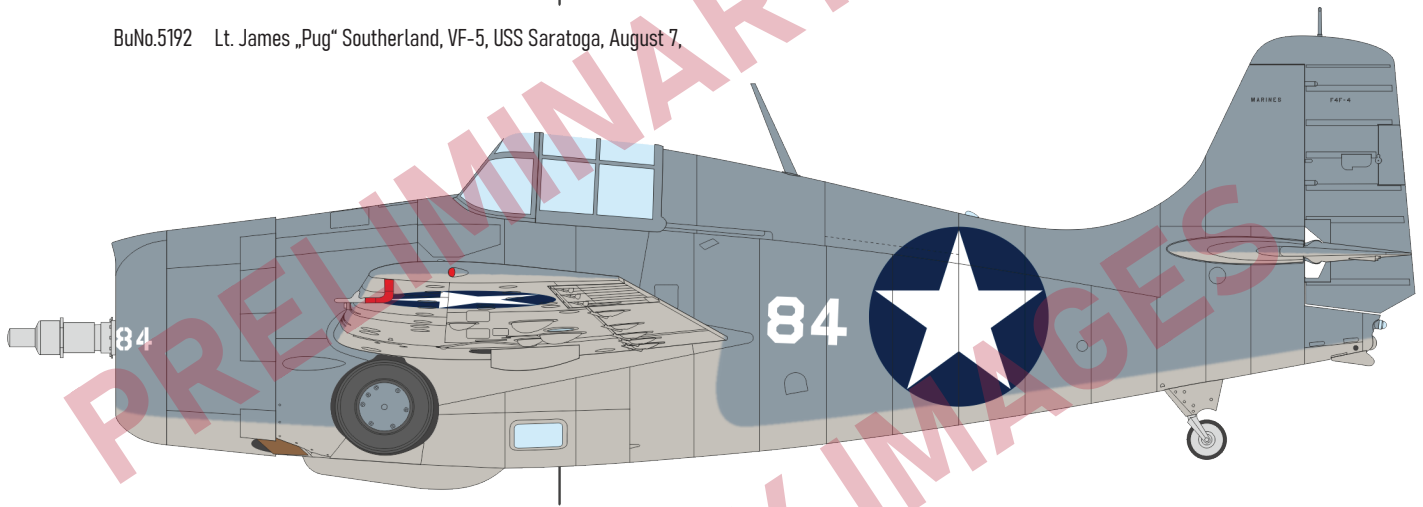

Capt. Joe Foss, VMF-121, Guadalcanal, Henderson Field, autumn 1942

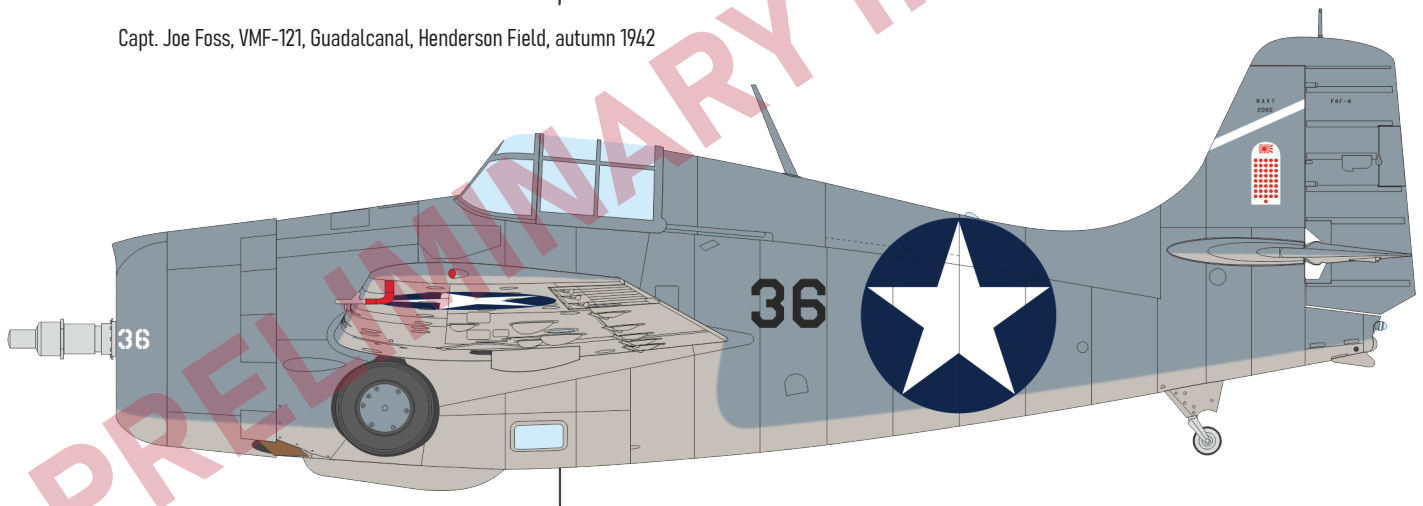

BuNo.02062 Mach. Donald E. Runyon, VF-6, USS Enterprise, August 1942

+ eight more marking options

Weekend edition kit of German WWII twin-engine multi role aircraft Messerschmitt Bf 110G-2 in 1/72 scale. This version of the Messerschmitt Bf 110 was used in the role fighter-bomber, fast bomber and destroyer, often used against Allied heavy bombers, equipped with WGr. 21 rockets or BK 3,7 cannon.

BASIC INFO:

NAME: **Bf 110G-2**

CAT. NO.: 7468

SCALE: 1/72

EDITION: Weekend edition

CONTENTS:

SPRUES: Eduard

PE-SETS: No

PAINTING MASK: No

MARKING OPTIONS: 4

BRASSIN: No

RELATED PRODUCTS:

72729 Bf 110G-2 (PE-Set)

SS798 Bf 110G-2 Weekend (PE-Set)

672013 Bf 110G wheels (Brassin)

672115 SC 50 German WWII bombs (Brassin)

672292 Luftwaffe rudder pedals PRINT (Brassin)

CX644 Bf 110G-2 (Mask)



KIT PARTS

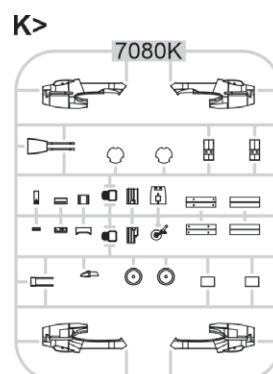
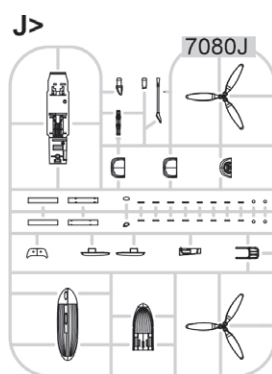
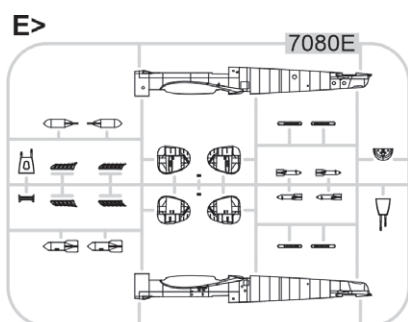
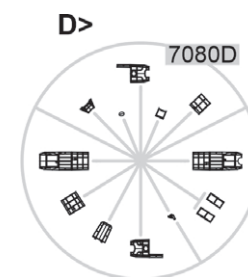
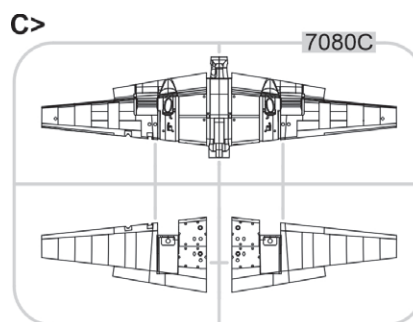
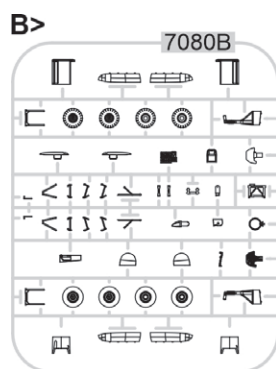
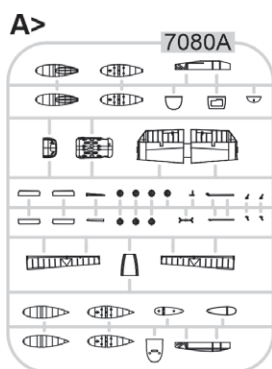

NO PREVIEW

ProfiPACK edition kit of Czechoslovak fighter aircraft Avia B.534 IV. serie in 1/48 scale.

Re-release

BASIC INFO:

NAME: **Avia B.534 IV.serie Re-release**

CAT. NO.: 8192

SCALE: 1/48

EDITION: ProfiPACK

CONTENTS:

SPRUES: Eduard

PE-SETS: Yes, pre-painted

PAINTING MASK: Yes

MARKING OPTIONS: 4

BRASSIN: No



RELATED PRODUCTS:

3DL48108 B.534 IV. serie SPACE (3D Decal Set)

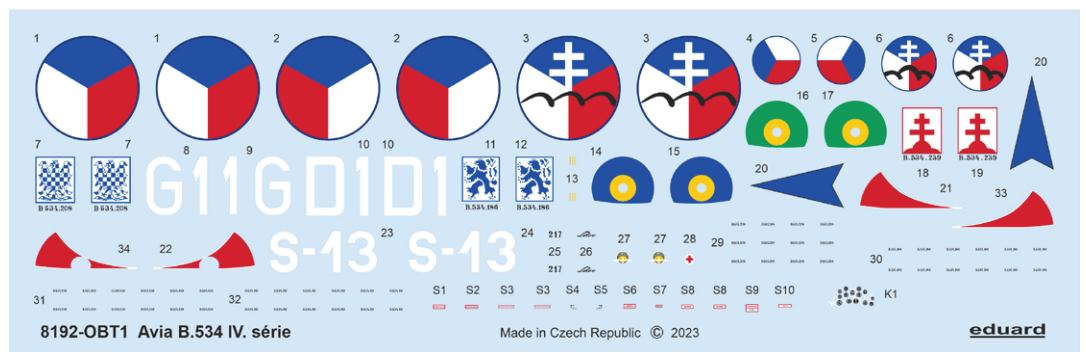

KIT PARTS

A>

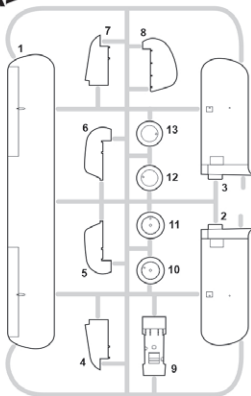

B>

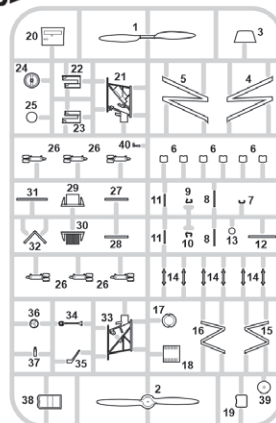

C>

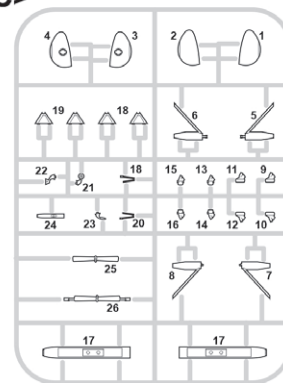

E>

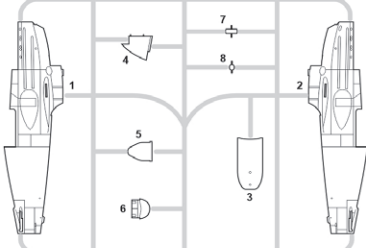

F>

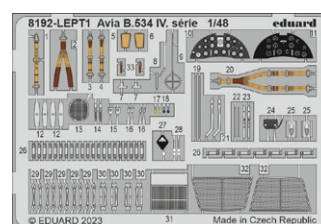
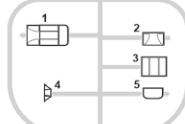

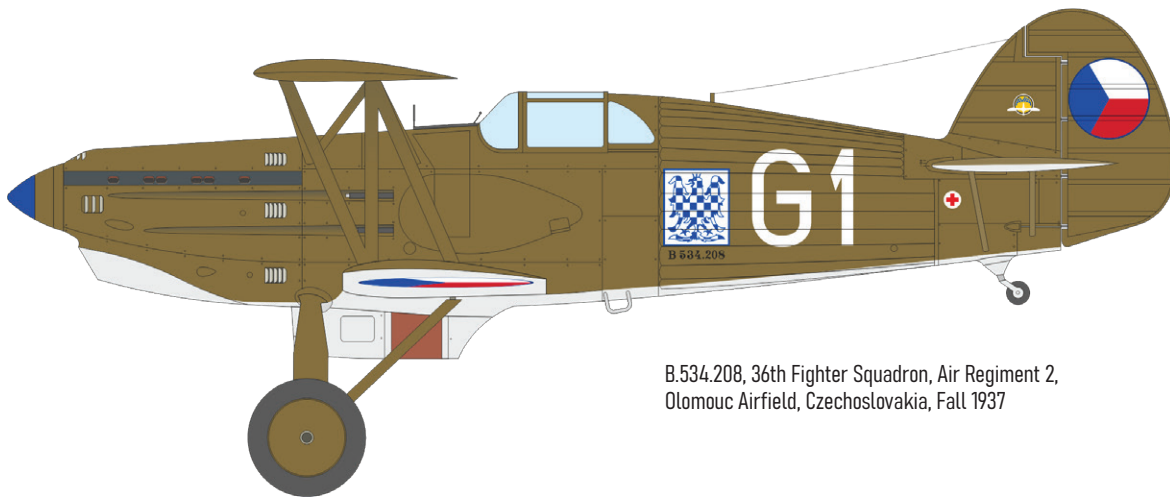

B.534.208, 36th Fighter Squadron, Air Regiment 2,
Olomouc Airfield, Czechoslovakia, Fall 1937

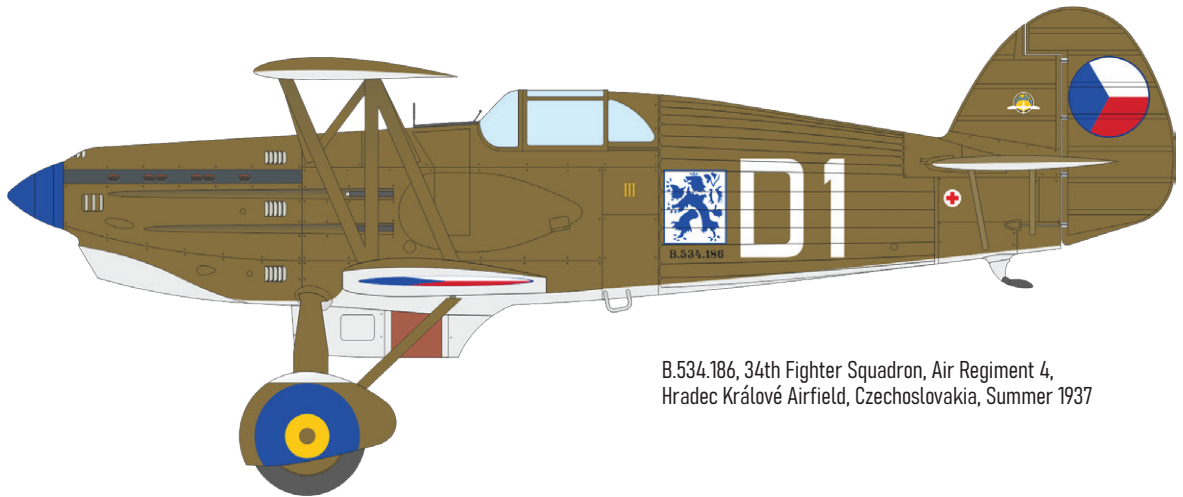

B.534.186, 34th Fighter Squadron, Air Regiment 4,
Hradec Králové Airfield, Czechoslovakia, Summer 1937

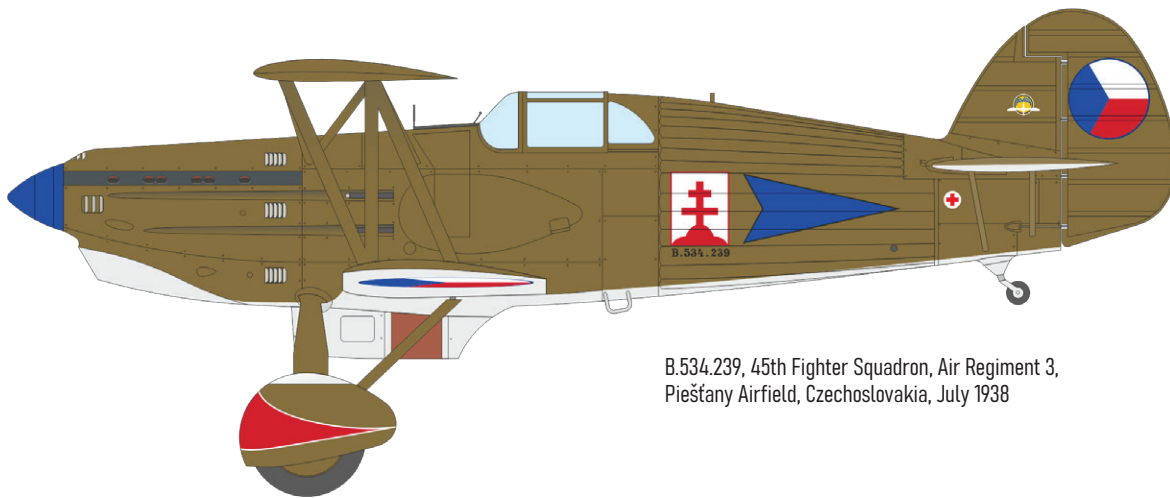

B.534.239, 45th Fighter Squadron, Air Regiment 3,
Piešťany Airfield, Czechoslovakia, July 1938



B.534.217, Combined Squadron of Slovak National Uprising,
Tri Duby Airfield, Slovakia, September 1944

ProfiPACK edition kit of Soviet Cold War aircraft MiG-21bis in 1/48 scale.

Re-release

BASIC INFO:

NAME: **MiG-21bis Re-release**

CAT. NO.: 8232

SCALE: 1/48

EDITION: ProfiPACK

CONTENTS:

SPRUES: Eduard

PE-SETS: Yes, pre-painted

PAINTING MASK: Yes

MARKING OPTIONS: 6

BRASSIN: No



RELATED PRODUCTS:

48704 MiG-21 ladder (PE-Set)

48994 MiG-21 surface panels (PE-Set)

48999 MiG-21bis exterior (PE-Set)

491036 MiG-21bis interior (PE-Set)

644033 MiG-21bis LööK (Brassin)

648026 MiG-21 wheels (Brassin)

648030 MiG-21 seat late (Brassin)

648050 MiG-21BIS interior (Brassin)

648051 MiG-21BIS exhaust nozzle (Brassin)

648082 R-60 / AA-8 Aphid (Brassin)

648049 MiG-21 wheel wells (Brassin)

648064 MiG-21 late airbrakes (Brassin)

648080 MiG-21 undercarriage legs BRONZE (Brassin)

648490 MiG-21 F.O.D. (Brassin)

3DL48026 MiG-21bis SPACE (3D Decal Set)

KIT PARTS

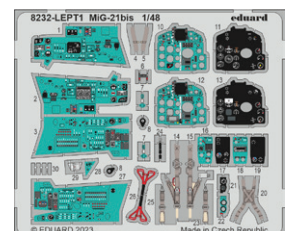
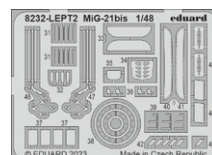
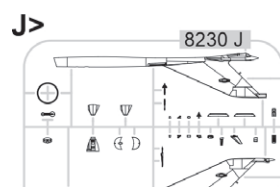
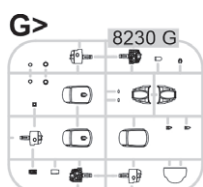
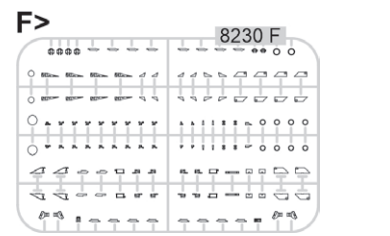
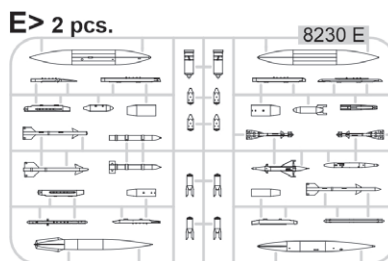
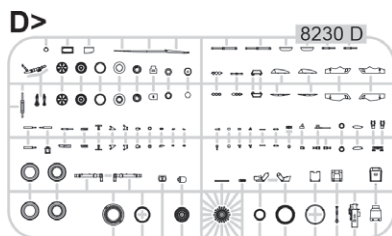
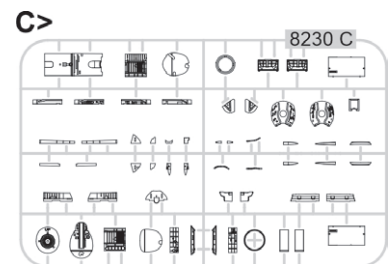
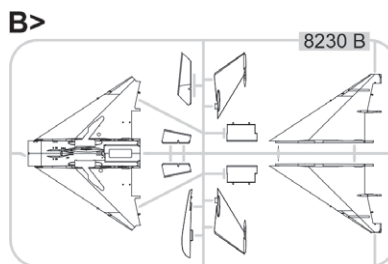
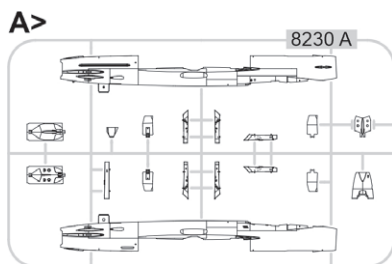

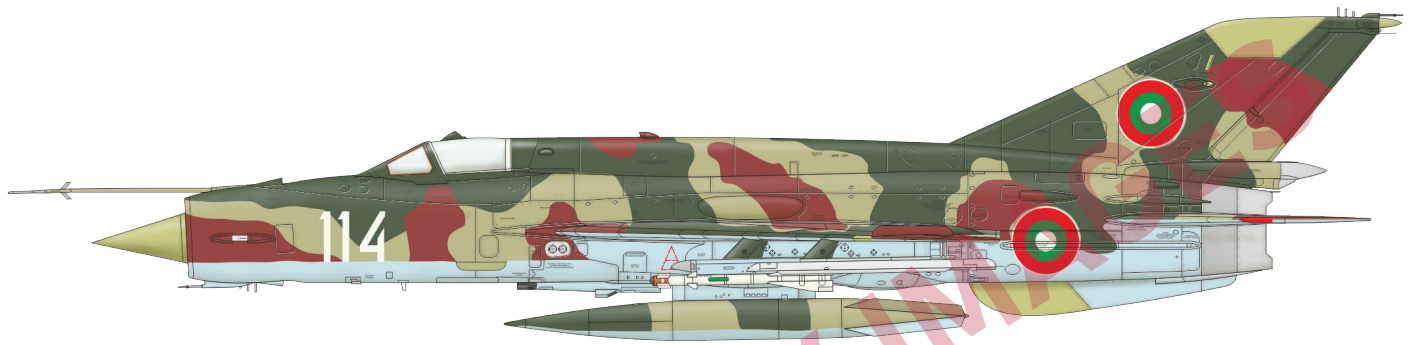

MiG-21BIS, 114, Izdelye 75B, 3rd Air Base, Graf Ignatevo, Bulgaria, from 2002



MiG-21BIS, MG129, Izdelye 75A, 31st Fighter Squadron, Kuopio airbase, Finland, 1980 - 1981

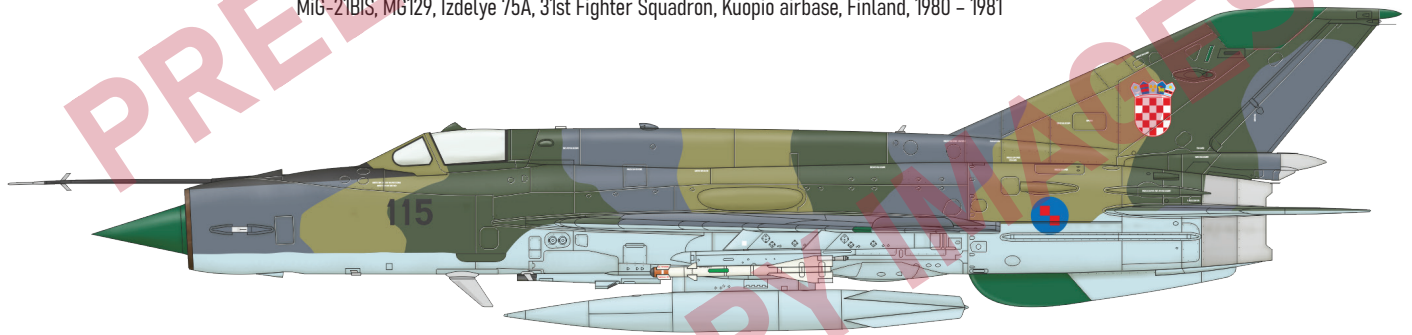

MiG-21BIS D, 115, Izdelye 75A, 22nd Fighter Squadron, Pula airbase, Croatia, 2008

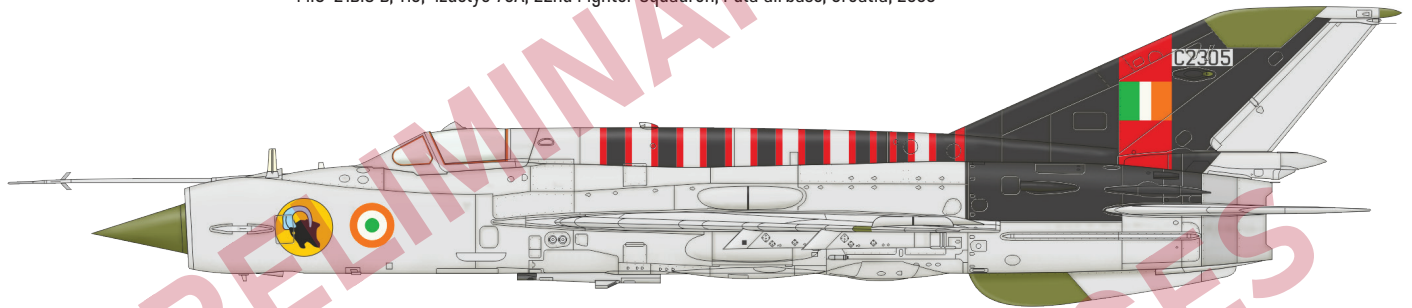

MiG-21BIS, C2305, Tactics & Air Combat Development Establishment, Jamnagar airbase, India, September, 1986

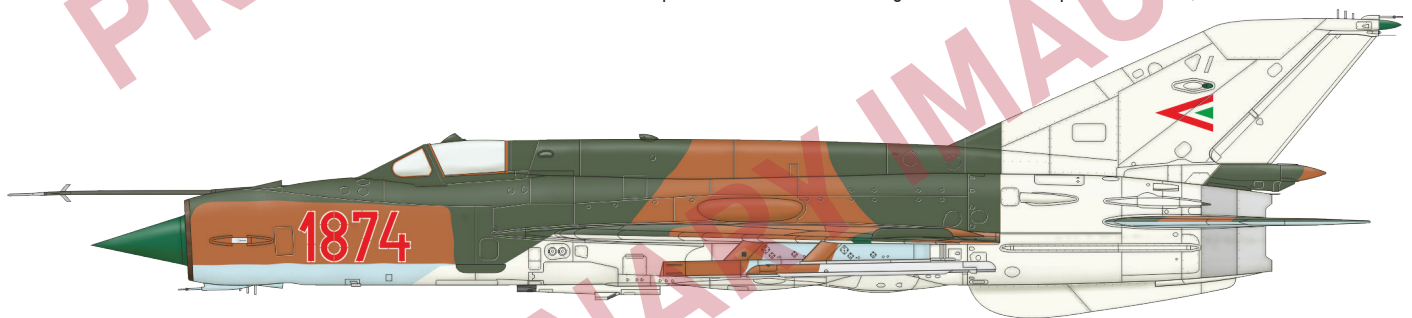

MiG-21BIS, 1874, Izdelye 75B, 47th Combat Air Regiment, Griff Squadron, Pápa airbase, Hungary, 1991

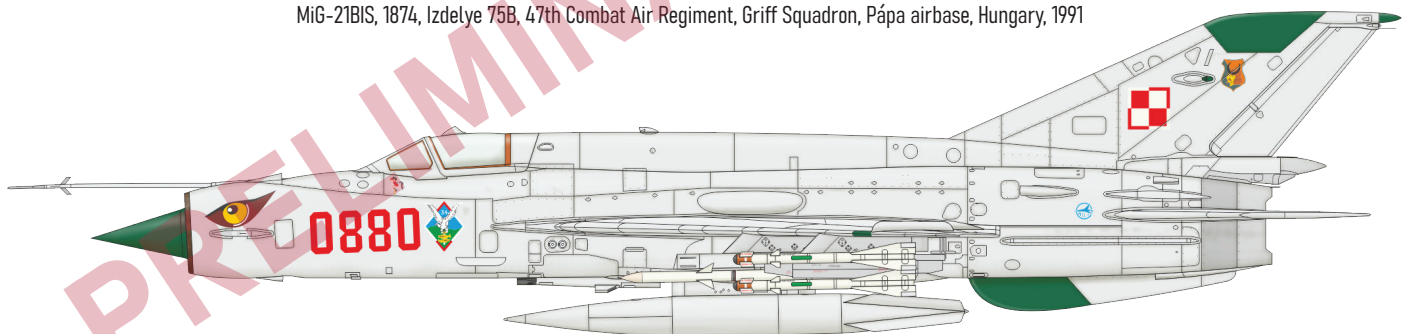

MiG-21BIS, 0880, 1st Air Division of Polish Navy, late 90's, Gdynia - Babie Doly airbase, Poland

53291 USS Alaska CB-1 part 3
1/350 Hobby Boss

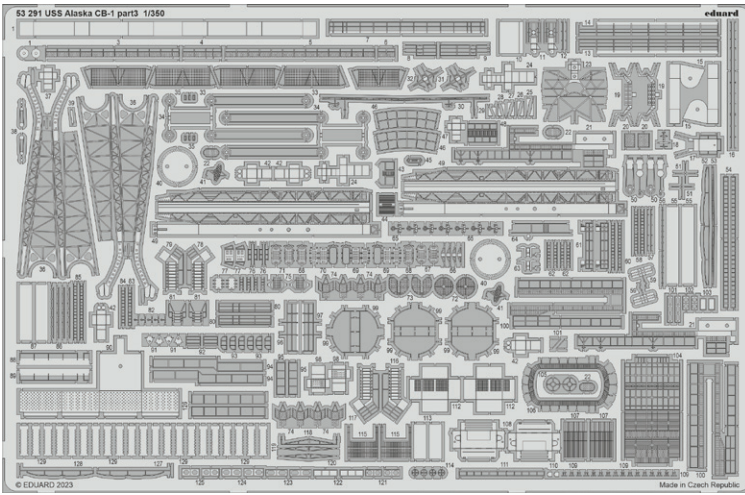

481101 B-25J bomb bay
1/48 HKM

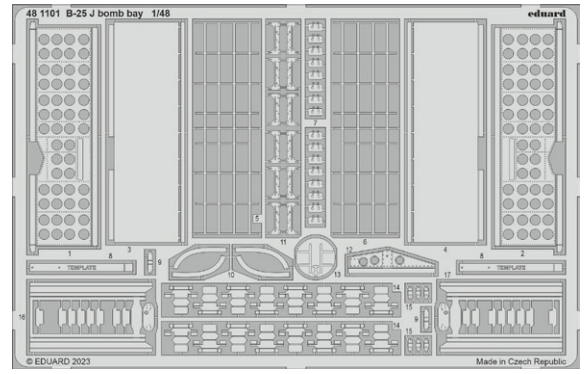

481102 B-24D exterior
1/48 Revell

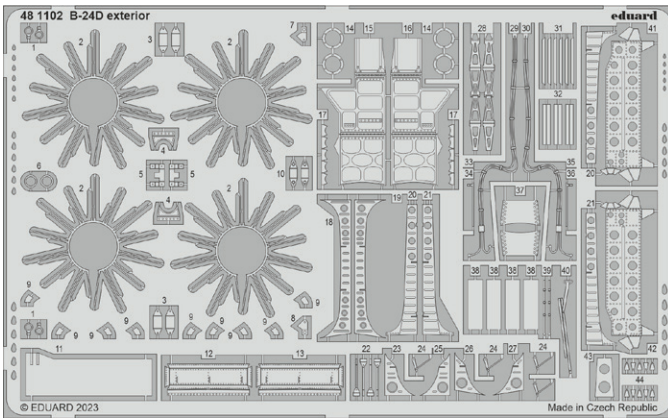

491332 F-35A
1/48 Tamiya

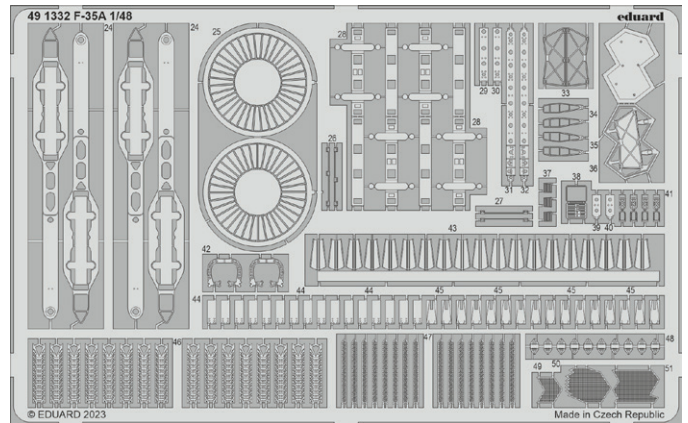

491334 F-16A MLU
1/48 Kinetic

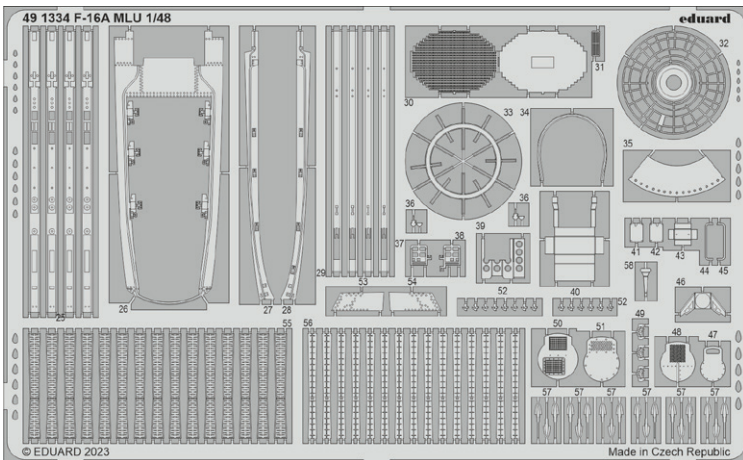

491336 B-25J glazed nose
1/48 HKM

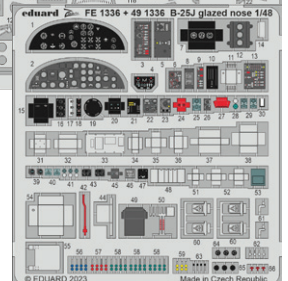
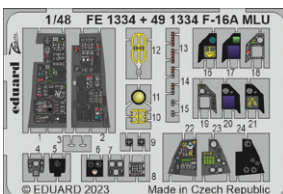
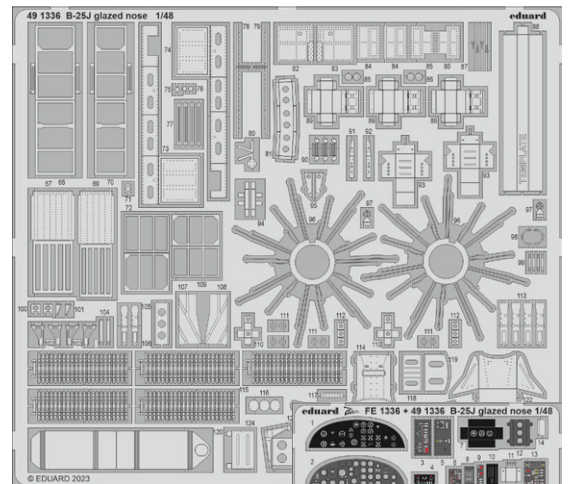

491338 B-24D cockpit
1/48 Revell

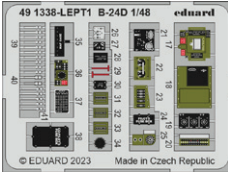
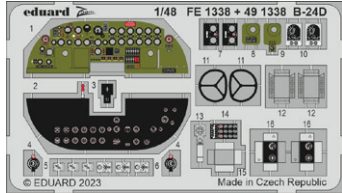
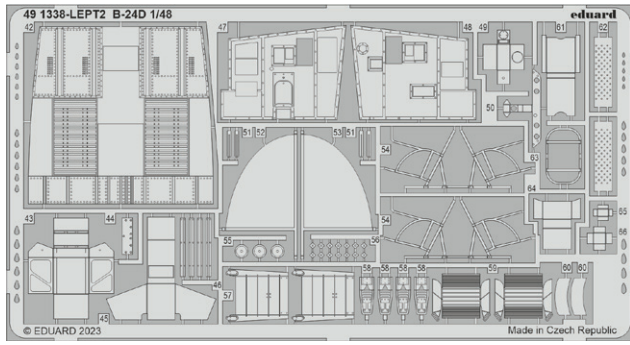

491339 B-24D nose interior
1/48 Revell

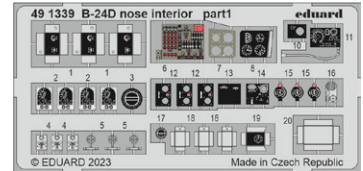
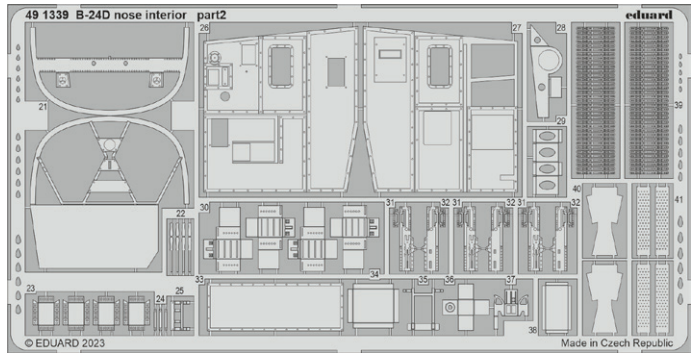

72728 C-130J exterior
1/72 Zvezda

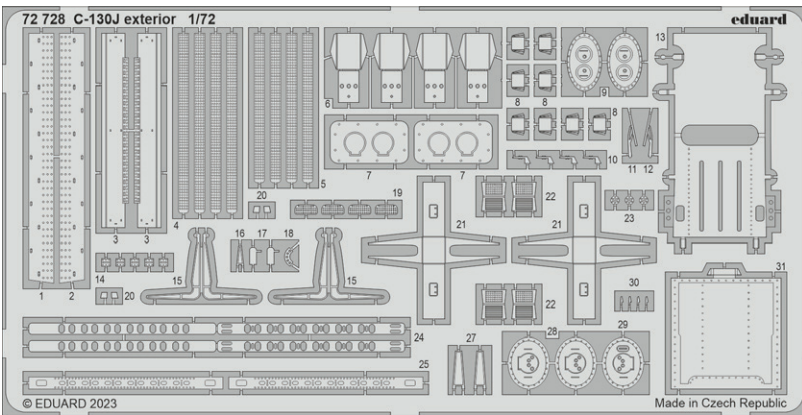

72729 Bf 110G-2
1/72 Eduard

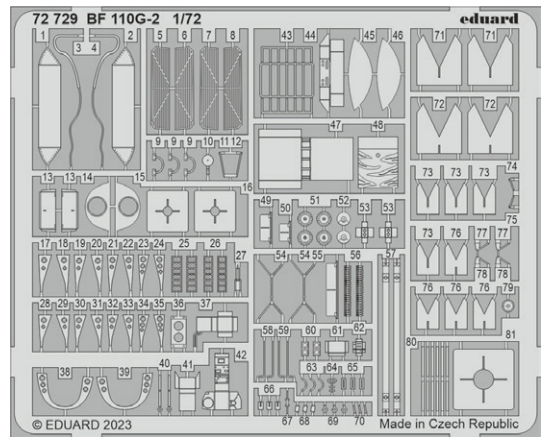

73794 C-130J interior
1/72 Zvezda

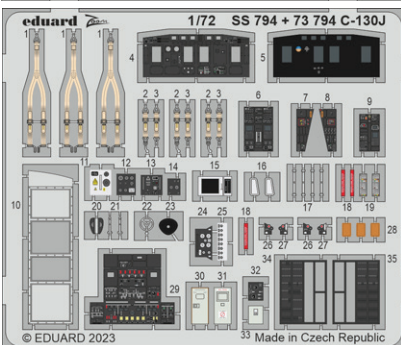
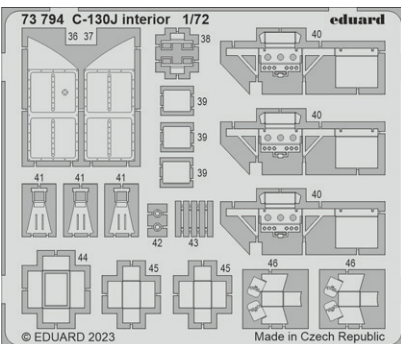

73795 C-130J cargo floor
1/72 Zvezda

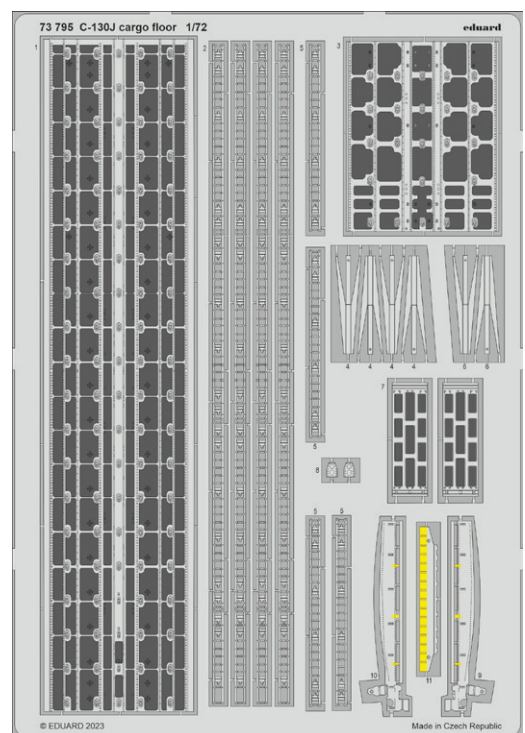

73796 C-130J cargo seatbelts
1/72 Zvezda

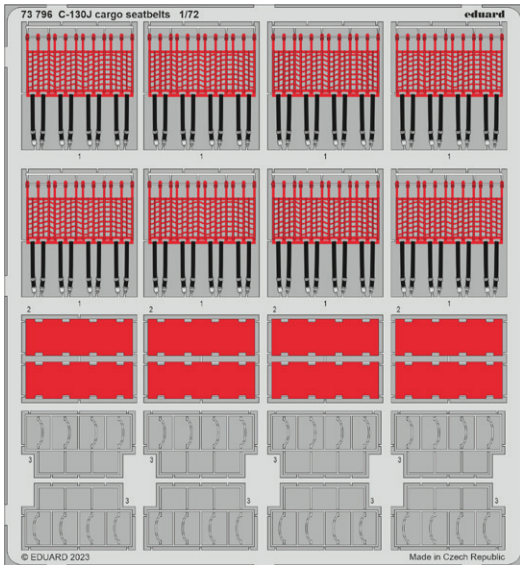

73797 C-130J cargo interior
1/72 Zvezda

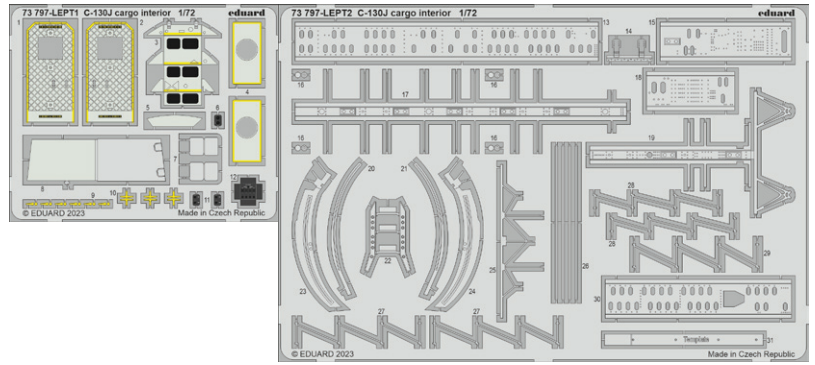

33344 Hurricane Mk.IIb seatbelts
STEEL 1/32 Revell

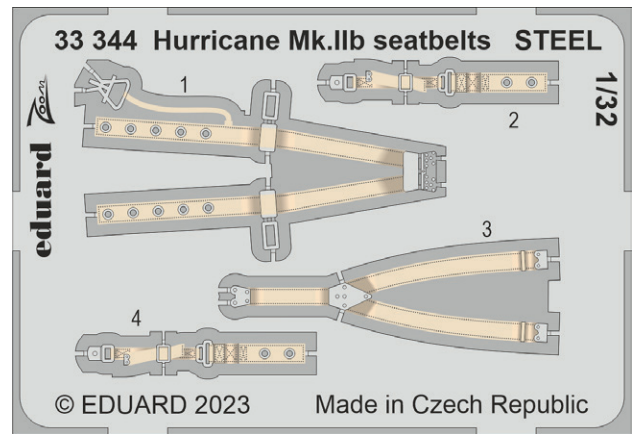

FE1334 F-16A MLU
1/48 Kinetic

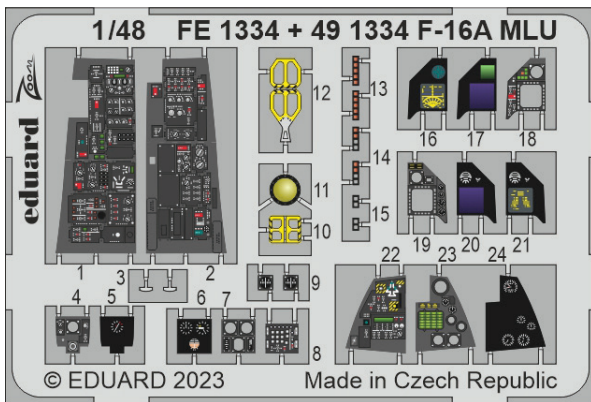

FE1335 F-16A MLU seatbelts STEEL
1/48 Kinetic

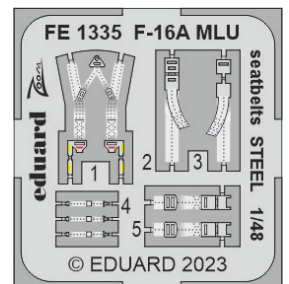

FE1336 B-25J glazed nose
1/48 HKM

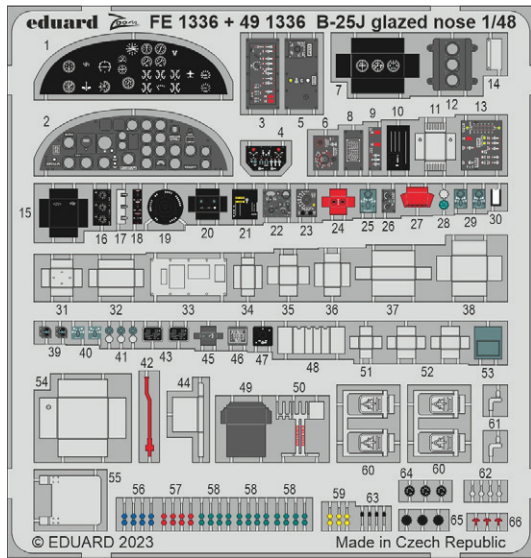

FE1337 B-25J glazed nose seatbelts STEEL
1/48 HKM

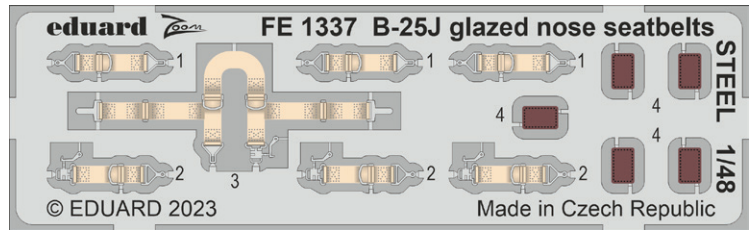

FE1338 B-24D
1/48 Revell

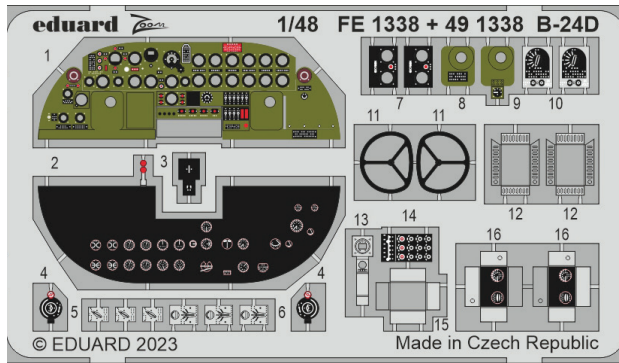

FE1339 B-24D seatbelts STEEL
1/48 Revell

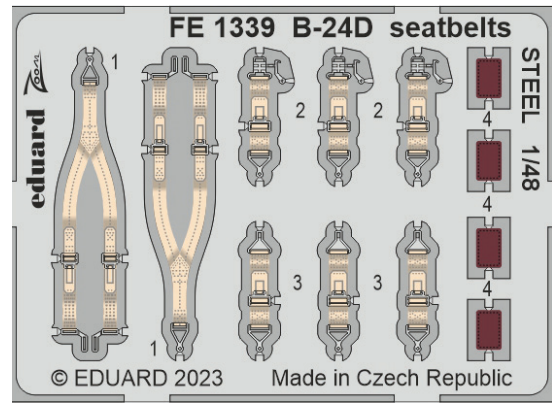

SS794 C-130J
1/72 Zvezda

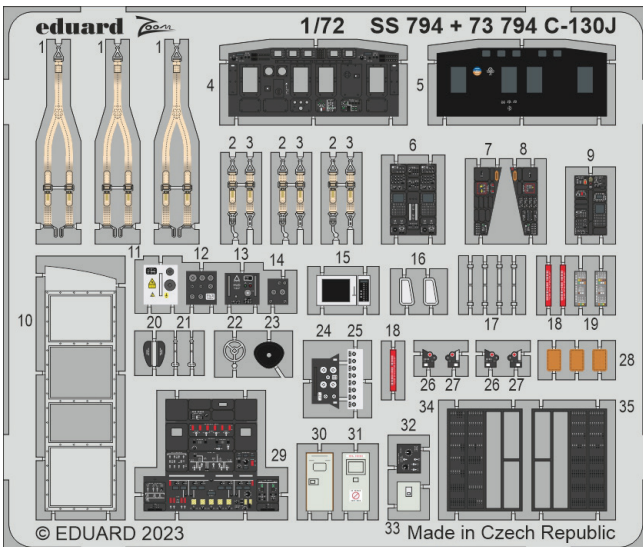

SS798 Bf 110G-2 Weekend
1/72 Eduard

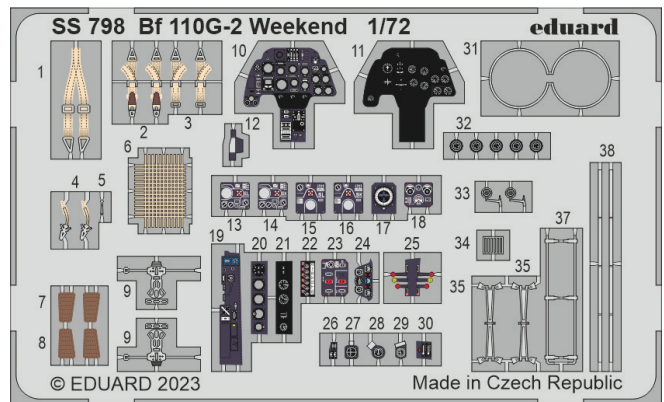

D48110 B-25J stencils
1/48 HKM

S1 S1 S2 S2 S3

S4 S5 S6

S7 S8

S9 S10 S11 S12 S13 S14

S15 S15

S16 S16 S17 S18 S19

S20 S21 S22 S23 S24

S25 S26 S27 S28 S29 S30

S31 S32 S33 S34 S35

S36 S36 S37 S38

S39 S39

S40 S41 S42 S43 S44

S45 S46 S47 S47 S48

S49 S50 S51

K1 K2 K3

D48110 B-25J stencils

Made in Czech Republic © 2023

eduard

644201 Mi-24V black (Mi-35) Löök 1/48 Eduard/Zvezda

Löök set - Brassin pre-painted dashboards and STEEL seatbelts for Mi-24V w/ black-painted interior (Mi-35) in 1/48 scale.

Easy to assemble, replaces plastic parts.

Recommended kit: Eduard / Zvezda

Set contains:

- resin: 2 parts
- decals: no
- photo-etched details: yes, pre-painted
- painting mask: no



644202 Anson Mk.I Löök 1/48 Airfix

Löök set - Brassin pre-painted dashboard and STEEL seatbelts for Anson Mk.I in 1/48 scale.

Easy to assemble, replaces plastic parts.

Recommended kit: Airfix

Set contains:

- resin: 1 part
- 3D print: 2 parts
- decals: no
- photo-etched details: yes, pre-painted
- painting mask: no

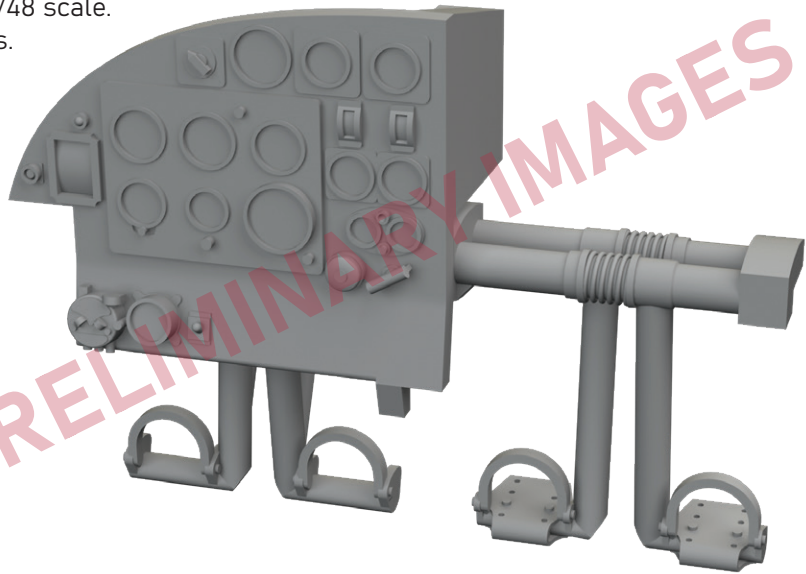

644203 F-35A Löök 1/48 Tamiya

Löök set - Brassin pre-painted dashboard and STEEL seatbelts for F-35A in 1/48 scale.

Easy to assemble, replaces plastic parts.

Recommended kit: Tamiya

Set contains:

- resin: 1 part
- decals: no
- photo-etched details: yes, pre-painted
- painting mask: no

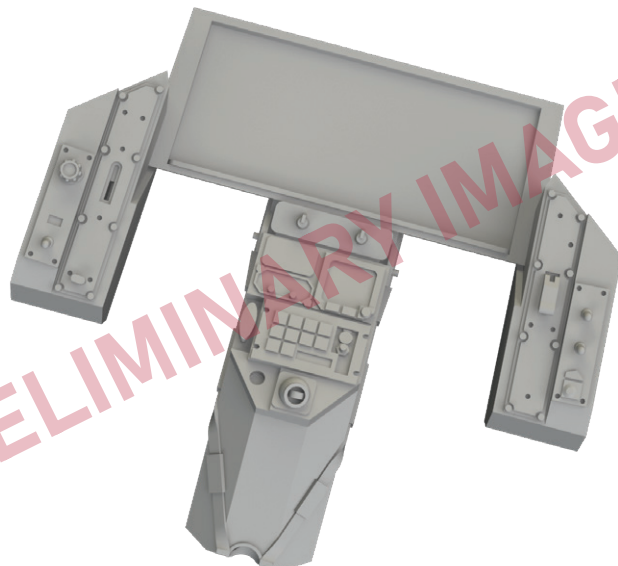

635023 WWII German NOTEK headlights PRINT 1/35

Brassin set - NOTEK headlights for German WWII AFV in 1/35 scale. The set consists of 12 pcs of NOTEK headlights. Made by direct 3D printing.

eduard
BRASSIN
Print

Set contains:

- 3D print: 12 parts
- decals: no
- photo-etched details: yes
- painting mask: no



635025 WWII German shovels PRINT 1/35

Brassin set - shovels for German WWII AFV in 1/35 scale. The set consists of 3 shovels. Made by direct 3D printing.

Set contains:

- 3D print: 3 parts
- decals: no
- photo-etched details: yes
- painting mask: no



eduard
BRASSIN
Print

648828 F4F-4 engine PRINT 1/48 Eduard

Brassin set - the engine for F4F-4 in 1/48 scale. The cowling are included. Made by direct 3D printing. Recommended kit: Eduard

eduard
BRASSIN
Print

Set contains:

- 3D print: 35 parts
- decals: no
- photo-etched details: yes
- painting mask: no

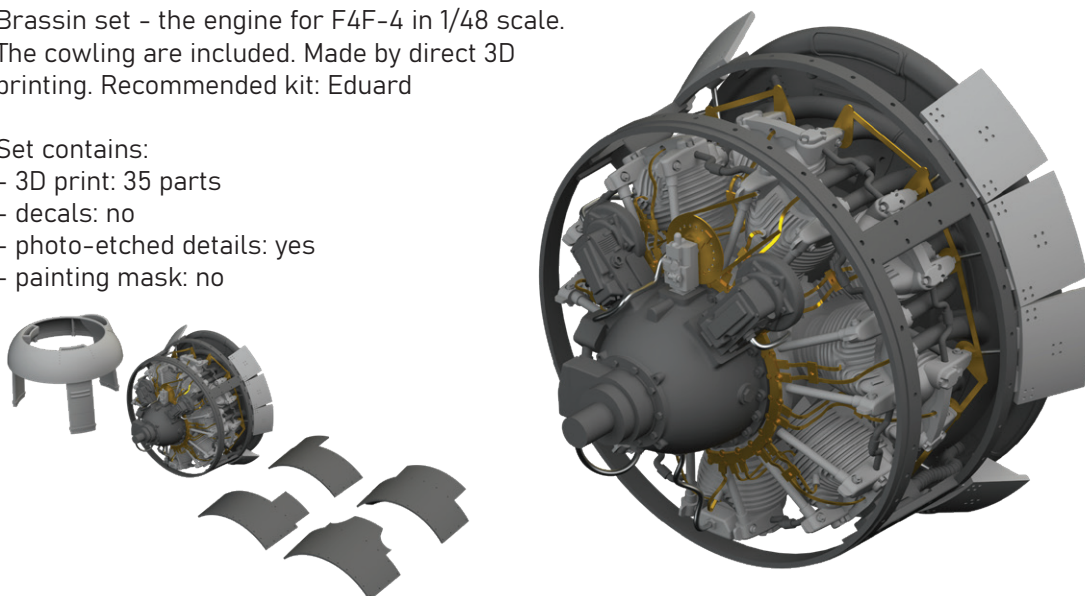

648829 F4F-4 wheel bay PRINT 1/48 Eduard

Brassin set - the wheel bay for F4F-4 in 1/48 scale.
Made by direct 3D printing. Recommended kit: Eduard

Set contains:

- 3D print: 10 parts
- decals: no
- photo-etched details: no
- painting mask: no

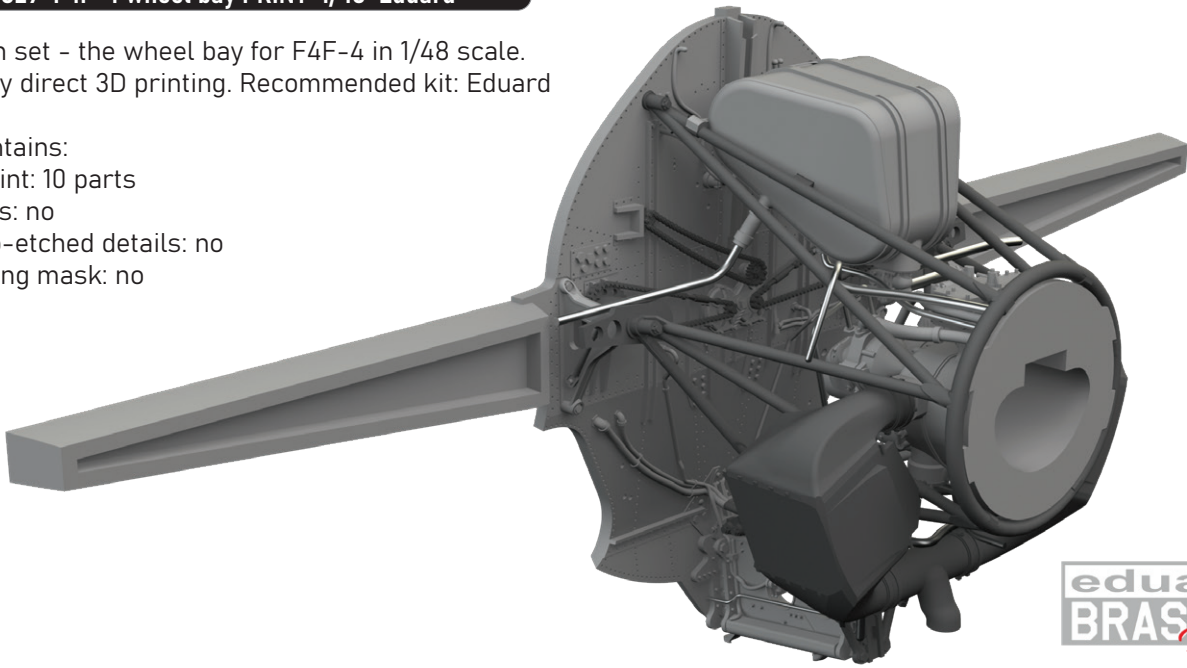

eduard
BRASSIN
Print

648835 Anson Mk.I wheels 1/48 Airfix

Brassin set - the undercarriage wheels for Anson Mk.I in 1/48 scale. The set consists of the main wheels and a tailwheel. Easy to assemble, replaces plastic parts. Recommended kit: Airfix

Set contains:

- resin: 3 parts
- decals: no
- photo-etched details: no
- painting mask: yes

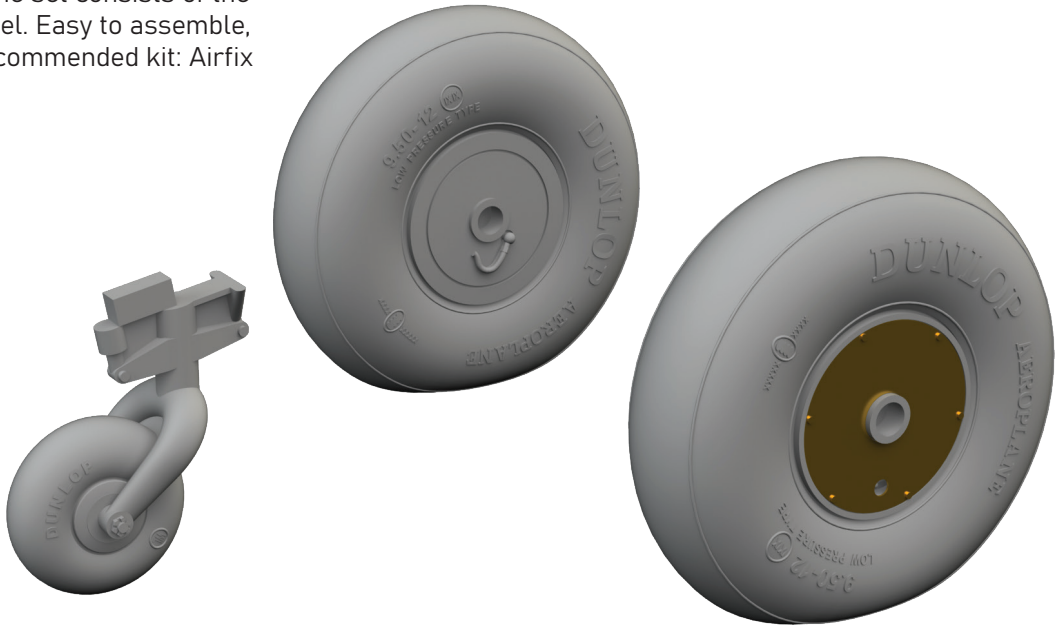

648836 ACES II ejection seat lower handles PRINT 1/48

Brassin set - pre-painted lower handles for ACES II ejection seats in 1/48 scale.
The set consists of the 5 handles.
Made by direct 3D printing.

Set contains:

- 3D print: 5 parts
- decals: no
- photo-etched details: no
- painting mask: no



eduard
BRASSIN
Print

648837 F-16 ejection seat PRINT 1/48 Kinetic

Brassin set - ejection seat for F-16 in 1/48 scale. Made by direct 3D printing. Recommended kit: Kinetic

Set contains:

- 3D print: 5 parts
- decals: yes
- photo-etched details: yes, pre-painted
- painting mask: no

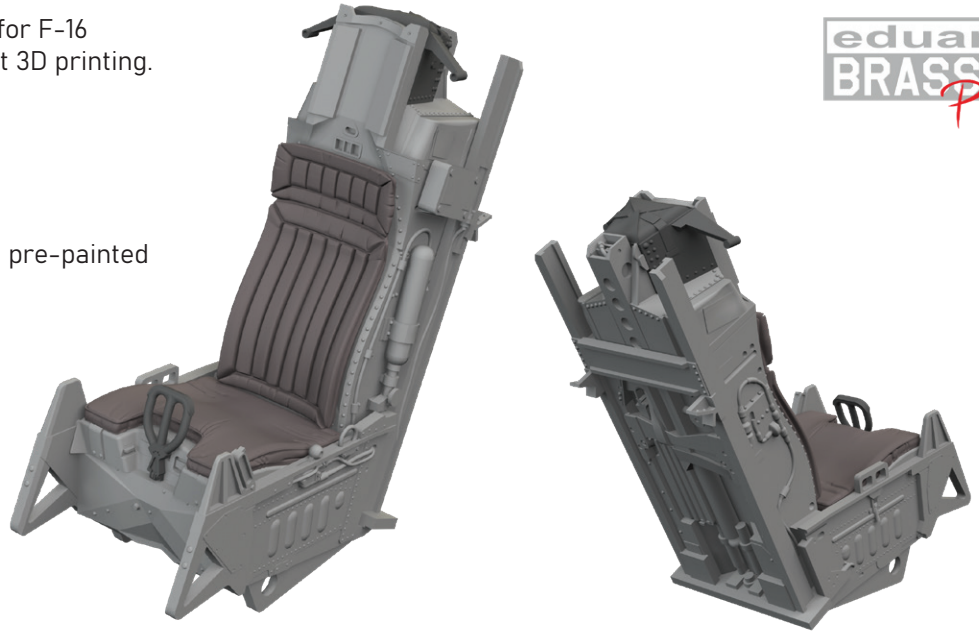

eduard
BRASSIN
Print

648838 Mi-24V cockpit black (Mi-35) PRINT & SPACE 1/48 Eduard/Zvezda

Brassin set - black-painted cockpit for Mi-24V (Mi-35) in 1/48 scale. Made by direct 3D printing. Recommended kit: Eduard / Zvezda

Set contains:

- 3D print: 10 parts
- resin: 46 parts
- decals: no
- photo-etched details: yes, pre-painted
- painting mask: no
- SPACE 3D decals: yes

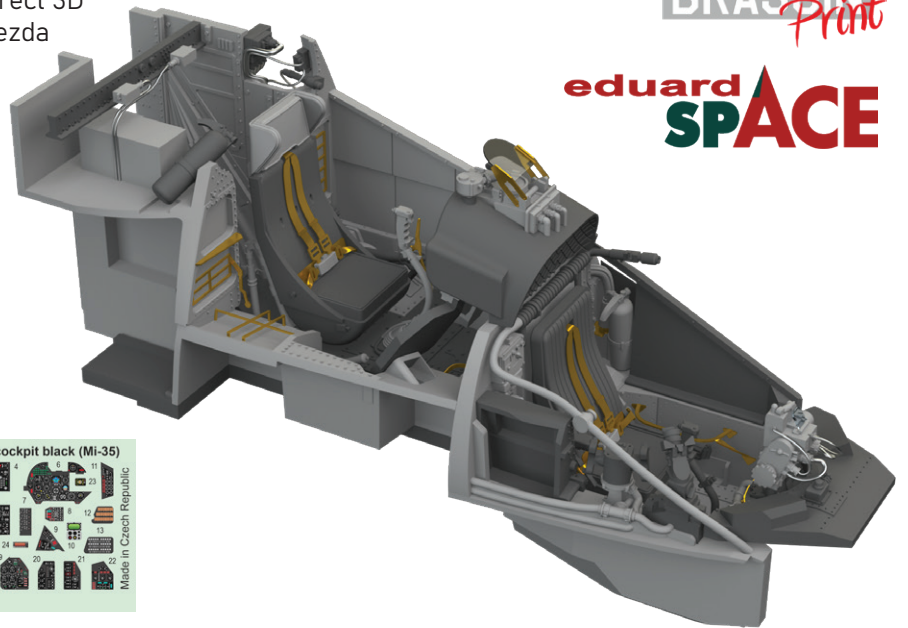

eduard
BRASSIN
Print

eduard
SPACE

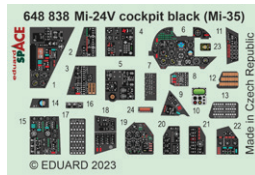
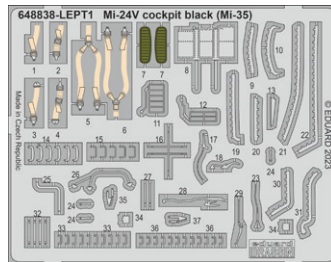

648839 F-35A wheels 1/48 Tamiya

Brassin set - the undercarriage wheels for F-35A in 1/48 scale. The set consists of the main wheels and a nose wheel. Easy to assemble, replaces plastic parts. Recommended kit: Tamiya

Set contains:

- resin: 3 parts
- decals: no
- photo-etched details: no
- painting mask: yes



648840 Beaufort Mk.I guns PRINT 1/48 ICM

Brassin set - guns for Beaufort Mk.I in 1/48 scale. Made by direct 3D printing. Easy to assemble, replaces plastic parts. Recommended kit: ICM

Set contains:

- 3D print: 4 parts
- decals: no
- photo-etched details: no
- painting mask: no

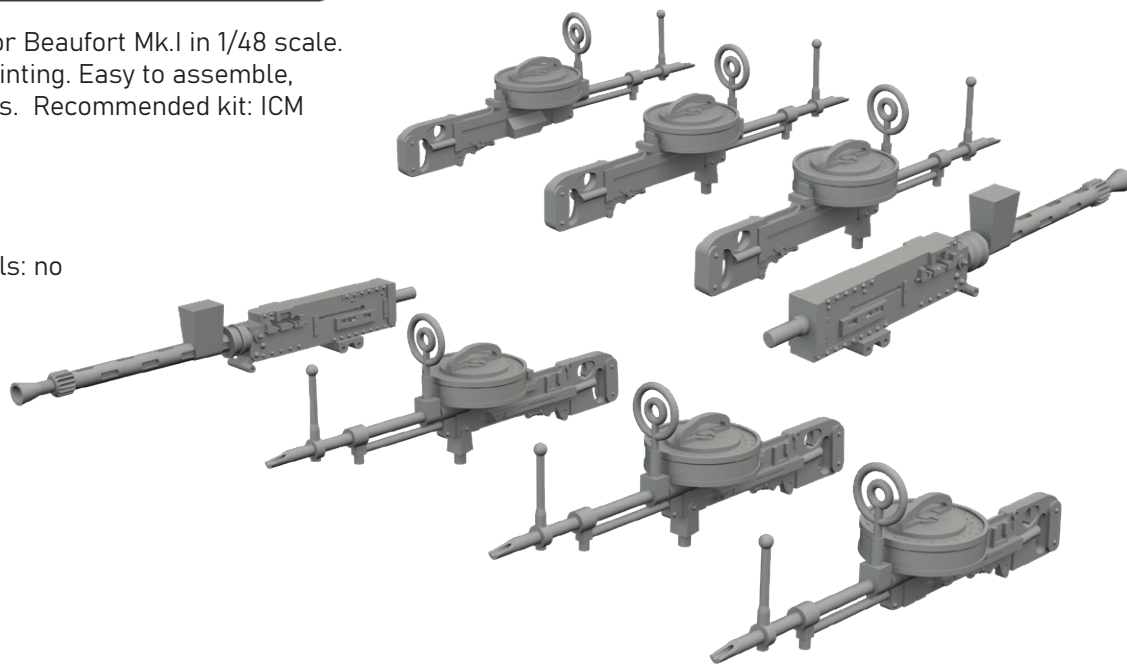

648841 Anson Mk.I radiators PRINT 1/48 Airfix

Brassin set - radiators for Anson Mk.I in 1/48 scale. The set consists of two radiators. Made by direct 3D printing. Easy to assemble, replaces plastic parts. Recommended kit: Airfix

Set contains:

- 3D print: 2 parts
- decals: no
- photo-etched details: no
- painting mask: no

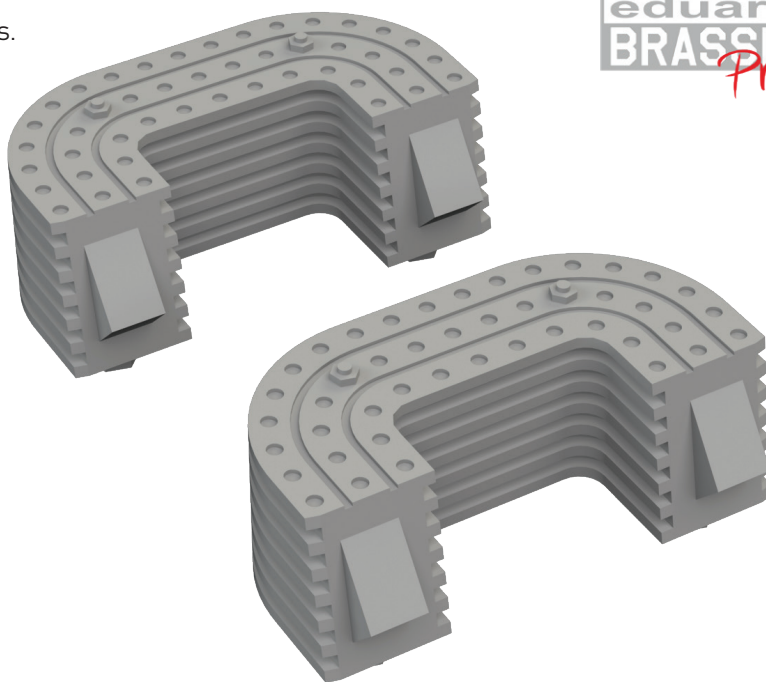

672308 P-39Q 500lb bomb PRINT 1/72 Arma Hobby

Brassin set - the 500lb bomb and a bomb rack for P-39Q in 1/72 scale. Made by direct 3D printing. Easy to assemble, replaces plastic parts. Recommended kit: Arma Hobby

Set contains:

- 3D print: 2 parts
- decals: yes
- photo-etched details: yes
- painting mask: no

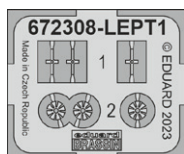
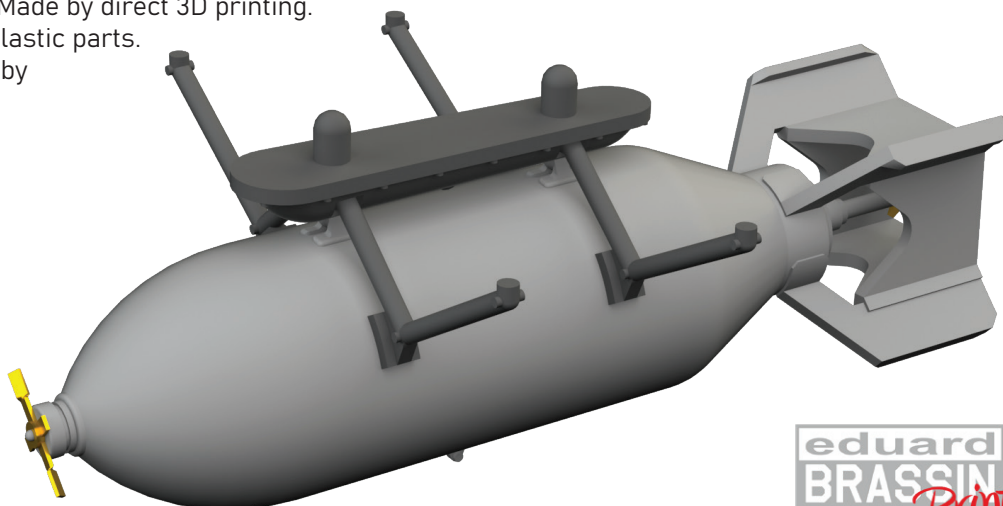

672309 P-39Q 75gal drop tank PRINT 1/72 Arma Hobby

Brassin set - 75gal drop tank and a rack for P-39Q in 1/72 scale. Made by direct 3D printing. Easy to assemble, replaces plastic parts. Recommended kit: Arma Hobby



Set contains:

- 3D print: 3 parts
- decals: no
- photo-etched details: no
- painting mask: no



634031 Bf 109G-2 LööKplus 1/32 Revell

Collection of 4 sets for Bf 109G-2 in 1/32 scale. Recommended kit: Revell

- LööK set (pre-painted Brassin dashboards & Steelbelts)
- TFace painting mask
- exhaust stacks
- undercarriage wheels

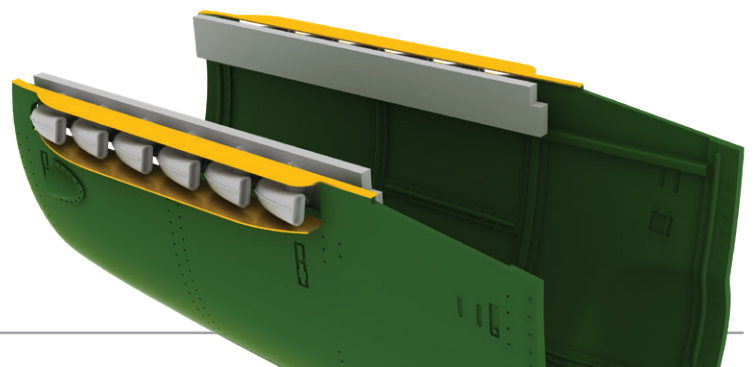
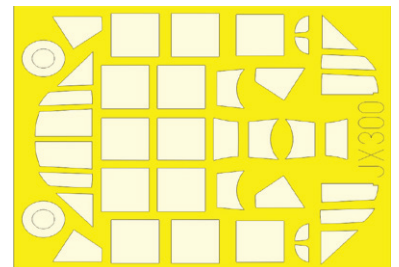
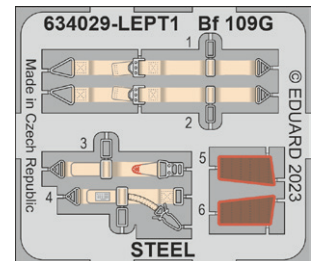

644197 Z-326 LööKplus 1/48 Eduard

Collection of 3 sets for Z-326 in 1/48 scale.
Recommended kit: Eduard

- LööK set (pre-painted Brassin dashboards & Steelbelts)
- TFace painting mask
- undercarriage wheels

LööK

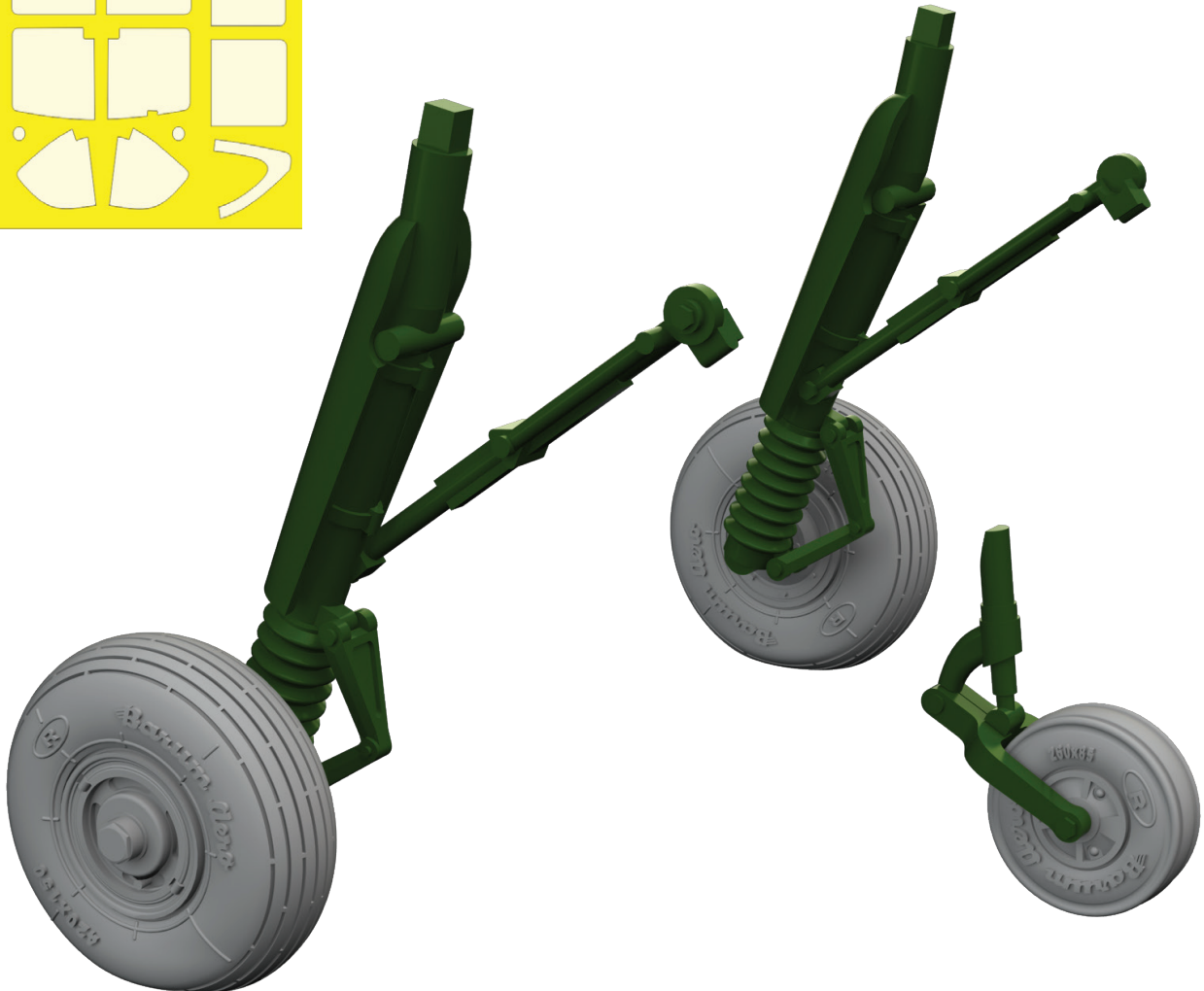
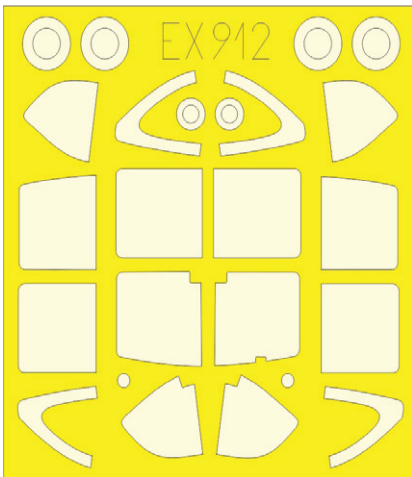
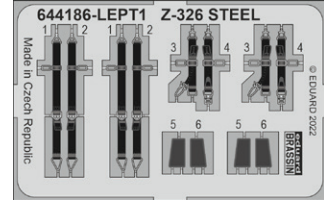

644199 Buccaneer S.2C/D LööKplus 1/48 Airfix

Collection of 4 sets for Buccaneer S.2C/D in 1/48 scale.
Recommended kit: Airfix

- LööK set (pre-painted Brassin dashboards & Steelbelts)
- TFace painting mask
- ejection seats
- undercarriage wheels

Löökt

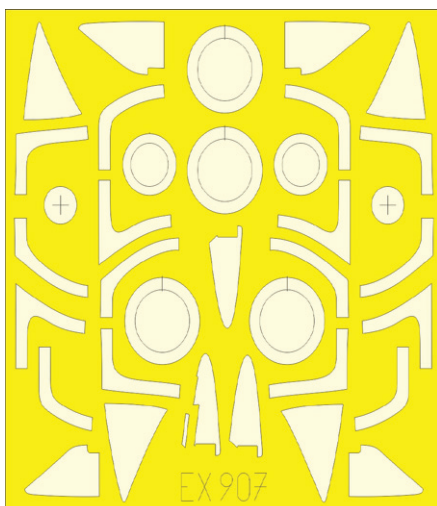
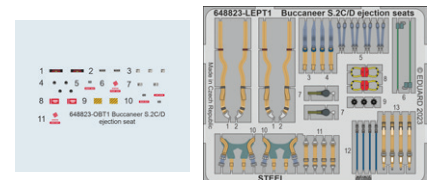
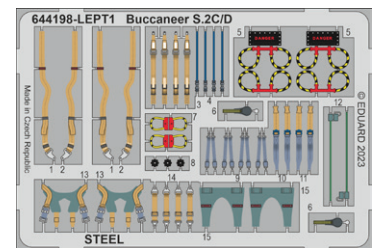
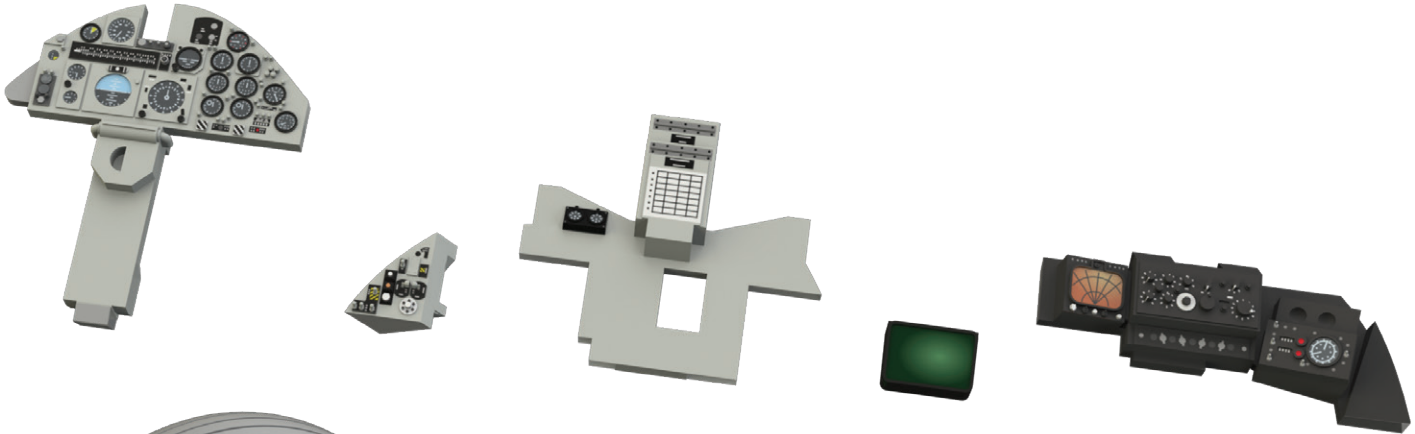

644200 Beaufort Mk.I LööKplus 1/48 ICM

Collection of 3 sets for Beaufort Mk.I in 1/48 scale.
Recommended kit: ICM

- LööK set (pre-painted Brassin dashboards & Steelbelts)
- TFace painting mask
- undercarriage wheels

LööK

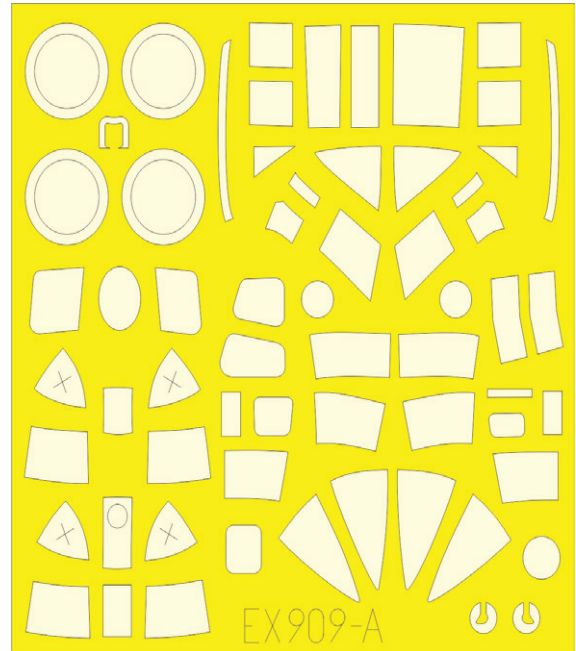
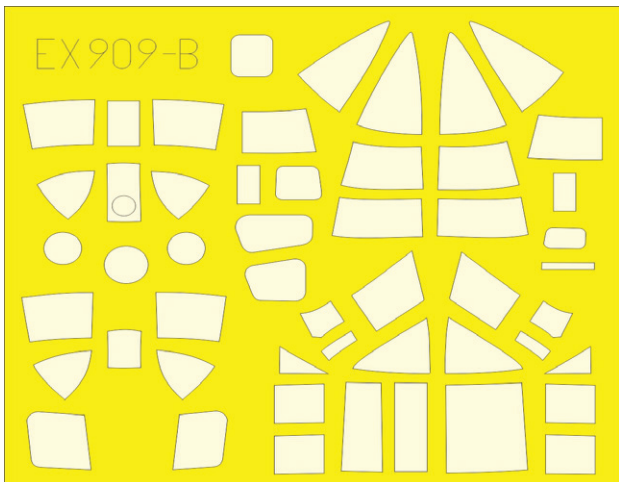
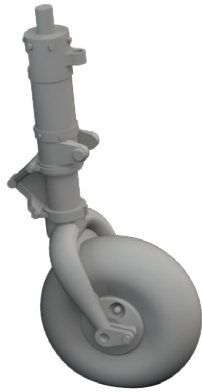
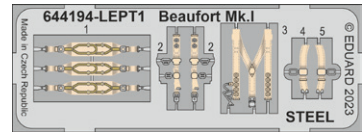

SIN648100 F-35A armament 1/48 Tamiya

Collection of 6 sets for F-35A in 1/48 scale.
Recommended kit: Tamiya

- AIM-120C AMRAAM (2 sets)
- AIM-9X
- AIM-132 ASRAAM
- GBU-12 bomb
- GBU-31(V)1/B JDAM



All sets included in this BIG SIN are available separately, but with every BIG SIN set you save up to 30 %.



SIN648101 Fw 190A-8 ESSENTIAL 1/48 Eduard

Collection of 4 sets for Fw 190A-8 in 1/48 scale.
Recommended kit: Eduard

- undercarriage wheels
- undercarriage legs BRONZE
- landing flaps PRINT
- cockpit PRINT

All sets included in this BIG SIN are available separately,
but with every BIG SIN set you save up to 30 %.

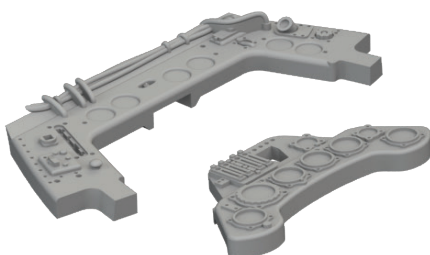
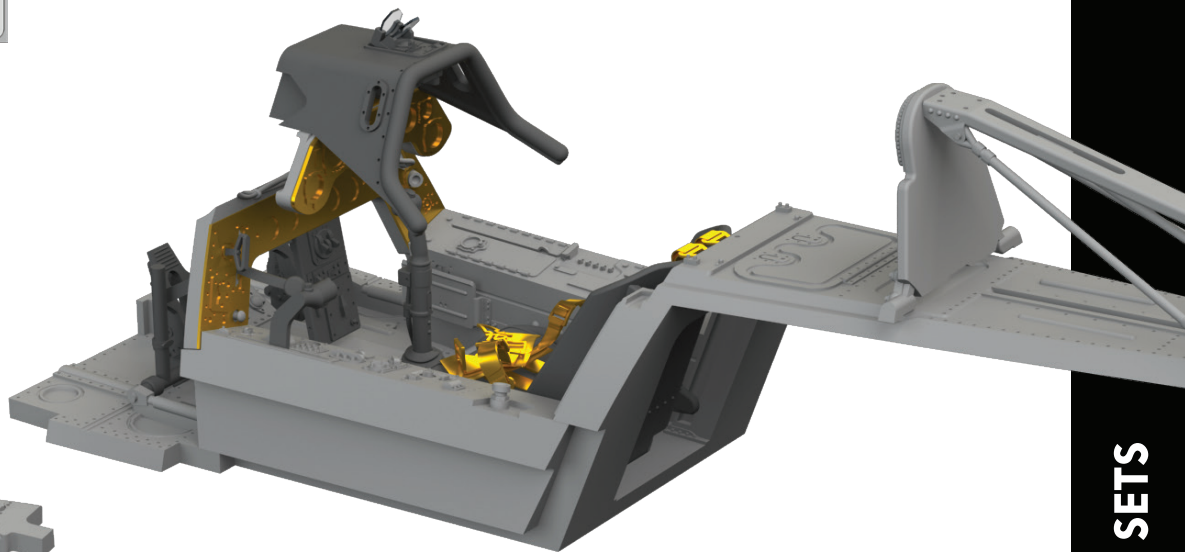
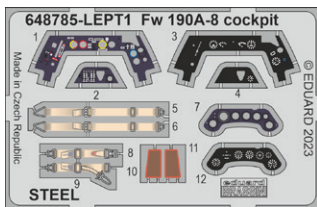
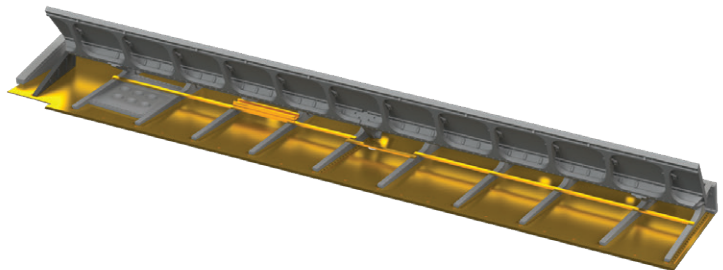
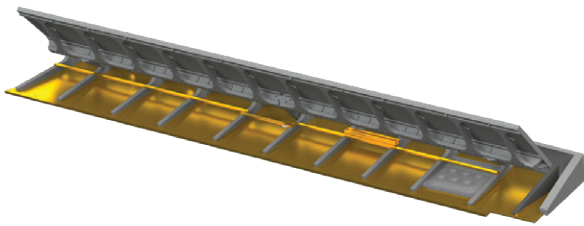
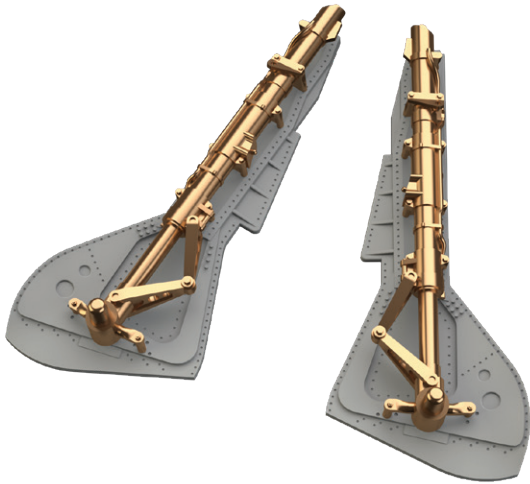

BIG33148 Bf 109G-2/4 1/32 Revell

- 321002 Bf 109G-2/4 1/32
- 33338 Bf 109G-2/4 seatbelts STEEL 1/32
- JX299 Bf 109G-2/4 1/32

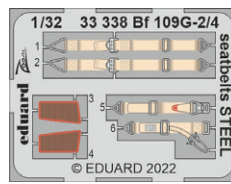
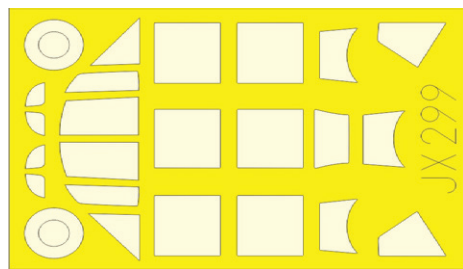
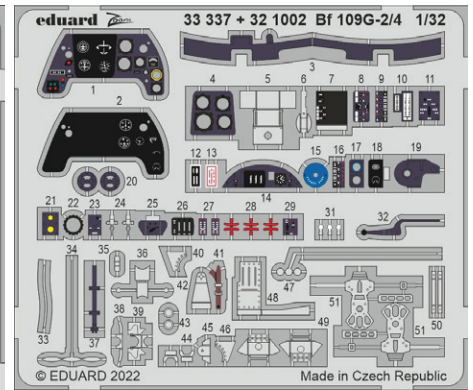
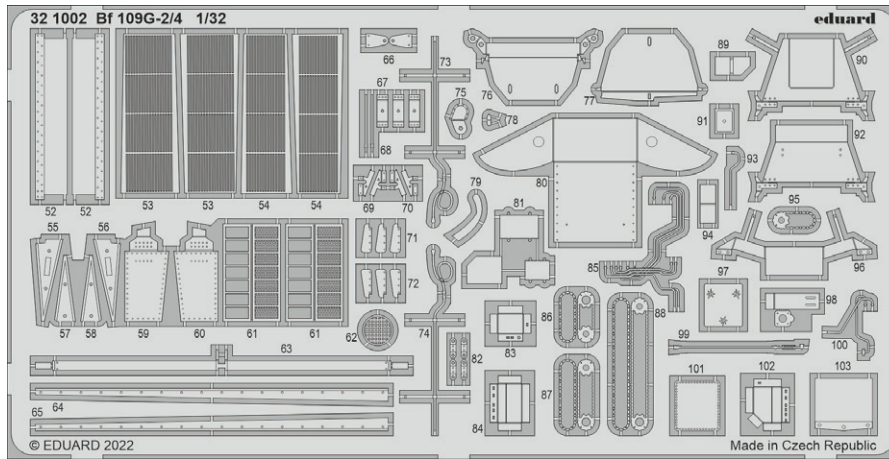

BIG33149 Yak-9K 1/32 ICM

- 32479 Yak-9K landing flaps 1/32
- 321003 Yak-9K 1/32
- 33340 Yak-9K seatbelts STEEL 1/32
- JX301 Yak-9K 1/32

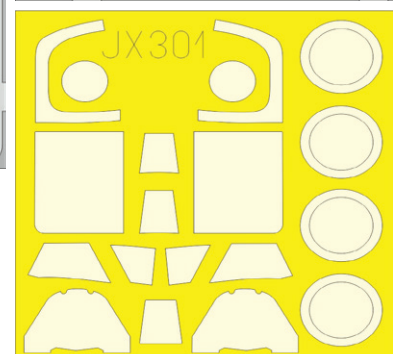
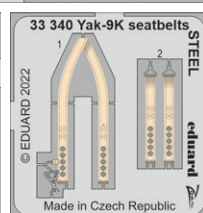
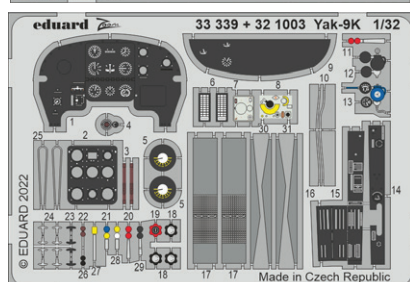
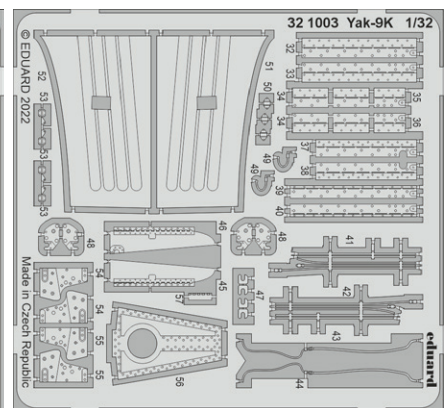
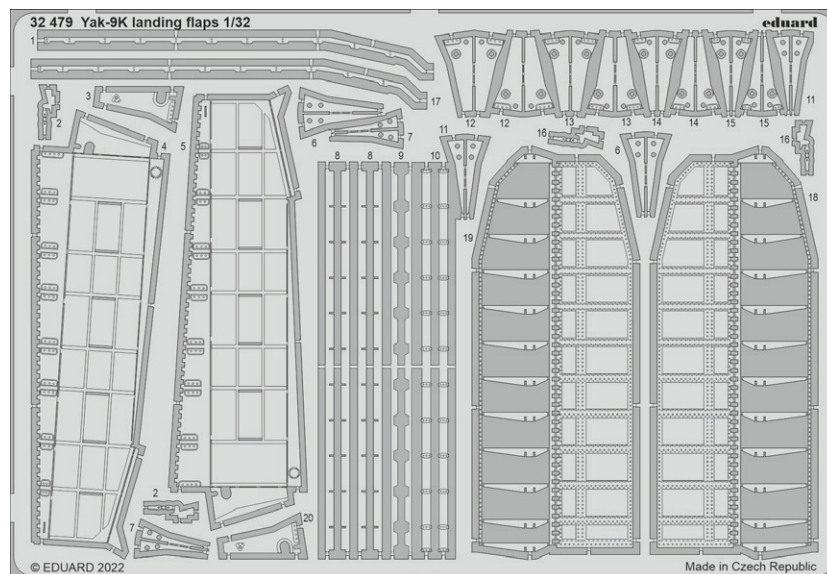

BIG49359 Mi-4 1/48 Trumpeter

- 491320 Mi-4 1/48
- FE1321 Mi-4 seatbelts STEEL 1/48
- EX910 Mi-4 1/48

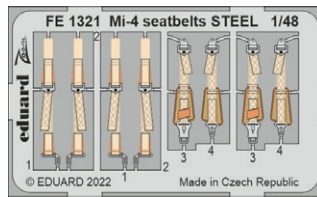
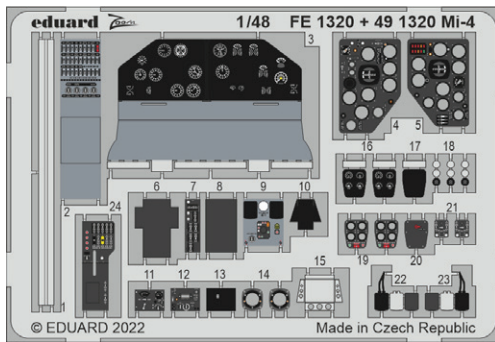
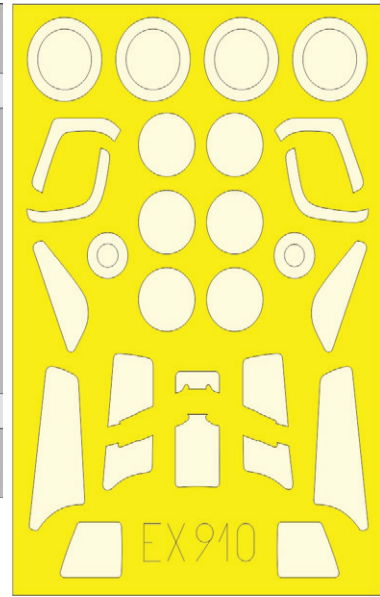
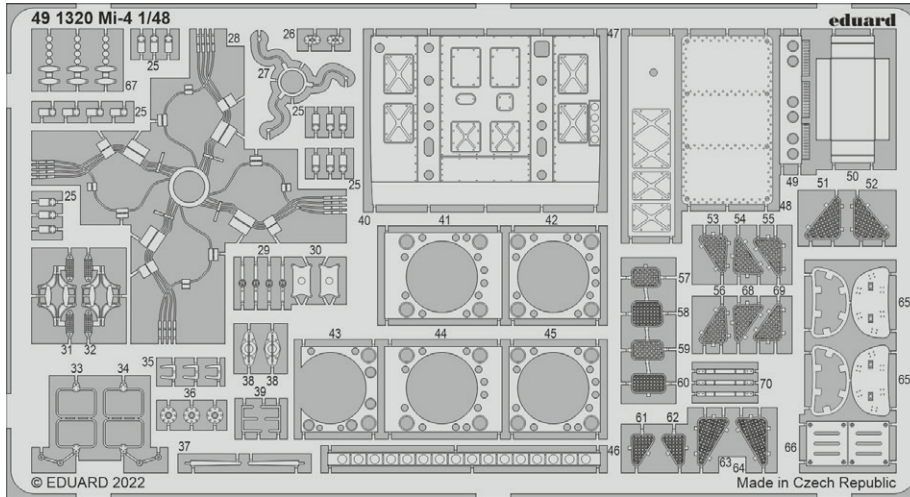

BIG49360 Beaufort Mk.I PART I 1/48 ICM

- 491318 Beaufort Mk.I 1/48
- FE1319 Beaufort Mk.I seatbelts STEEL 1/48
- EX908 Beaufort Mk.I 1/48

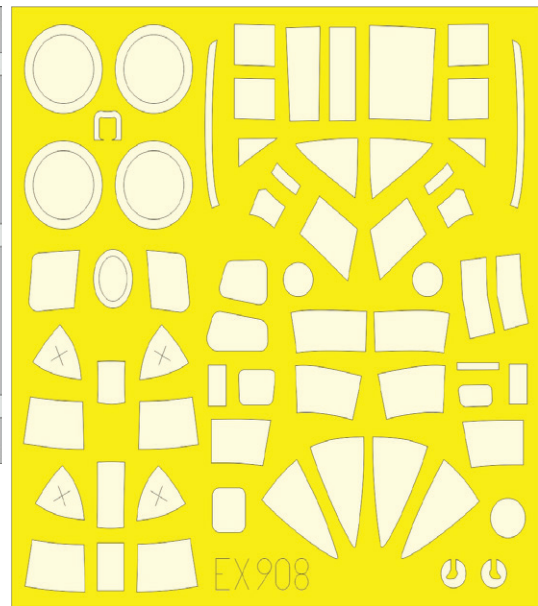
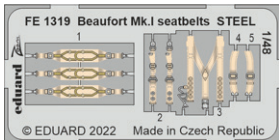
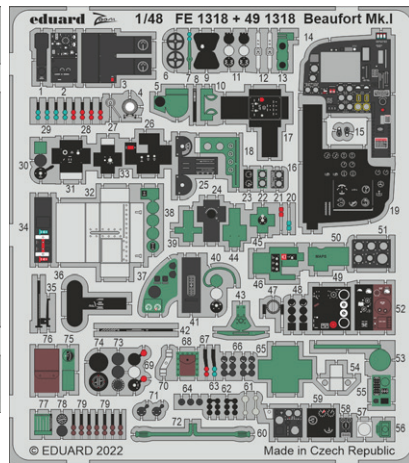
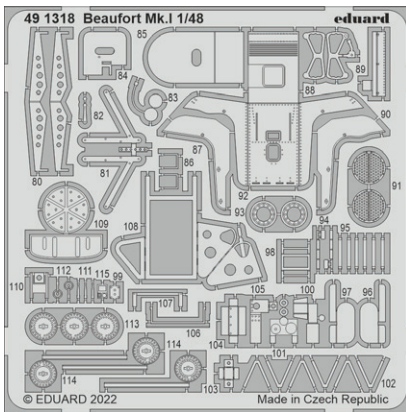

#SIN64899

P-38J ESSENTIAL

1/48 TAMIYA

Collection of 3 sets for P-38J in 1/48 scale.
Recommended kit: Tamiya

- cockpit PRINT
- wheels
- undercarriage legs BRONZE

All sets included in this BIG SIN are available separately, but with every BIG SIN set you save up to 30 %.

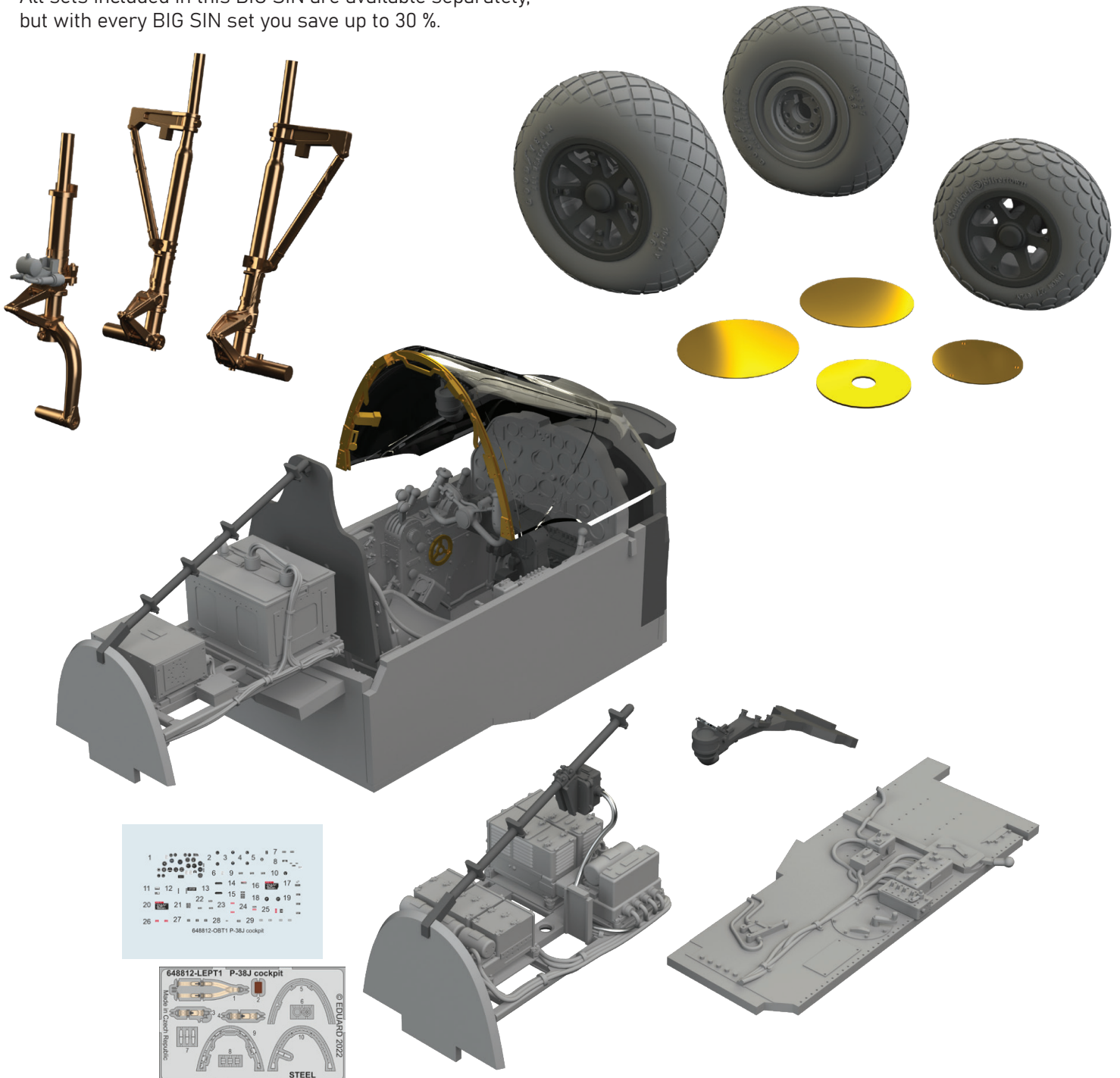

1	2	3	4	5	7	-
6	9	-	10	8	-	-
11	12	13	14	15	16	17
20	21	22	23	24	25	19
26	27	28	29	-	-	-

648812-CBT1 P-38J cockpit

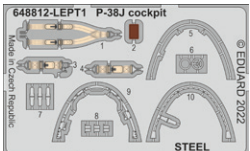

eduard



Bf 110E 1/48

ProfiPACK
edition

ProfiPACK edition kit of German WWII twin-engine heavy fighter aircraft Messerschmitt Bf 110E in 1/48 scale.

WILD CARDS 

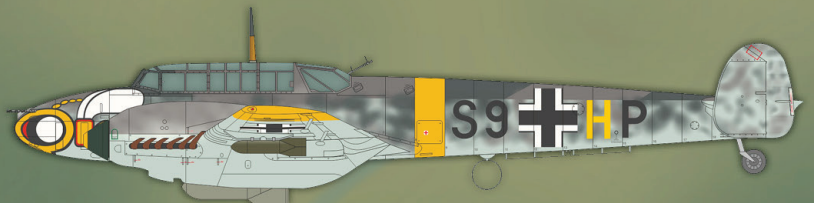

6./ZG 1, Russia, Summer 1942



4./NJG 1, St. Trond, Belgium, February 1942



Lt. Felix-Maria Brandis, 1.(Z)/JG 77, Malmi, Finland, 1942

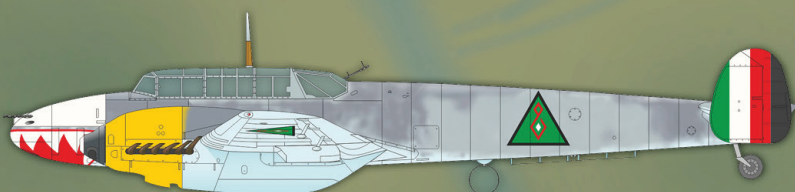

4./ZG 76, Sonderkommando Junck, Mosul Air Base, Iraq, May 1941



Lt. Herbert Kutscha, 5./ZG 1, Soviet Union, 1942

#8203

www.eduard.com

#648834

MB Mk.6 ejection seat upper handles PRINT

1/48 

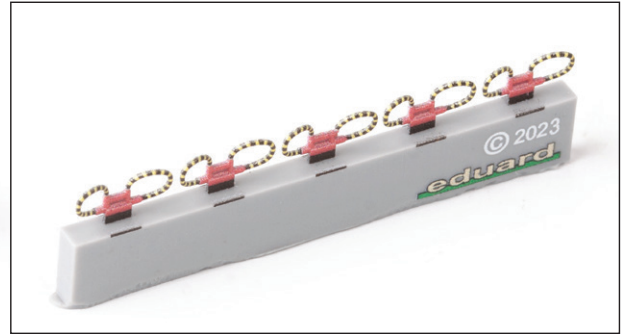
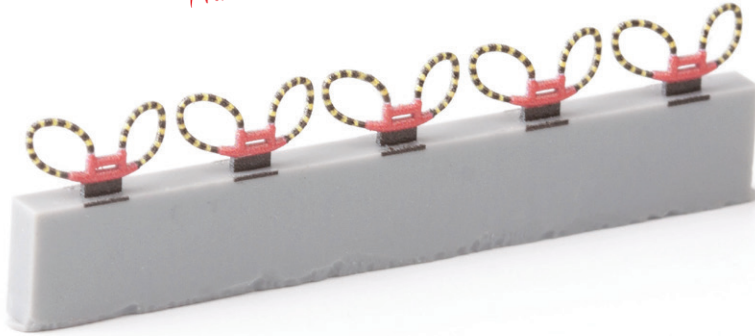

#644195

F-35B LööKplus

1/48 Italeri

Collection of 3 sets for F-35B in 1/48 scale.
Recommended kit: Italeri

- LööK set (pre-painted Brassin dashboards & Steelbelts)
- TFace painting mask
- undercarriage wheels

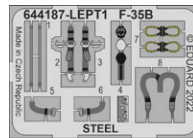
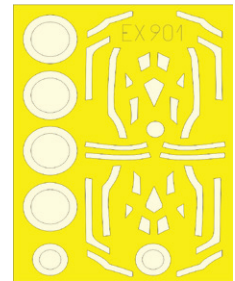
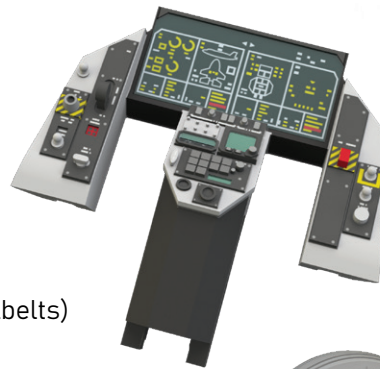

LööK+

#BIG49357

F-35B

1/48 Italeri

- 49103 Remove Before Flight STEEL
- 491312 F-35B
- FE1313 F-35B seatbelts STEEL
- EX900 F-35B

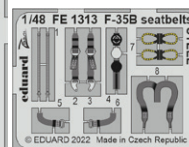
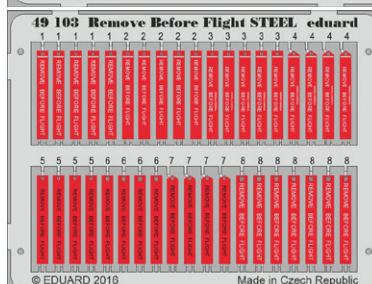
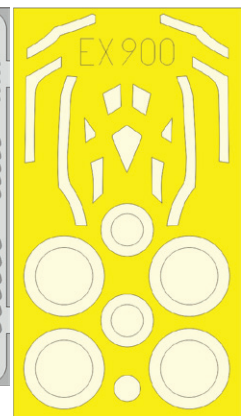
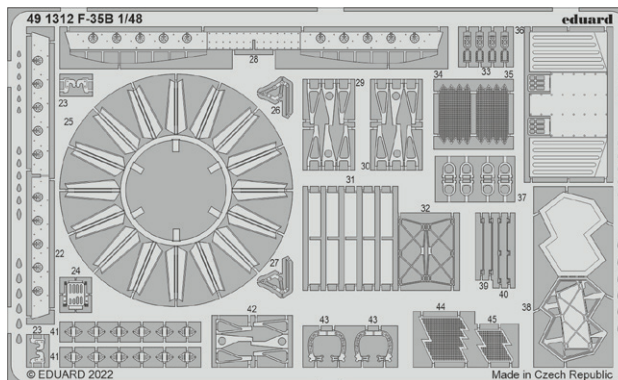

BIG ED