

**eduard**  
**MASK**

**TA-7**

**1/72**

The die-cut mask for accurate canopy frame painting of the  
*Hobby Boss* scale *1/72 KIT*

**CX 231**

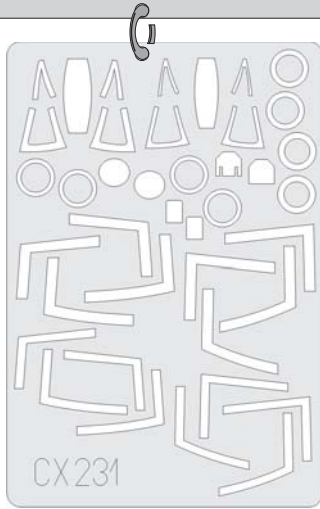

 - LIQUID MASK  
MASCOL

**H1**  
2PCS

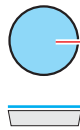

**E8**  
2PCS

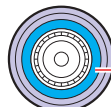

**E10**  
2PCS

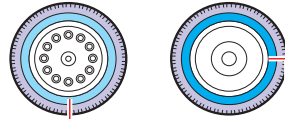

**H2**



**H3**



**E9**  
2PCS

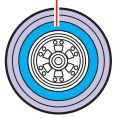

1.)

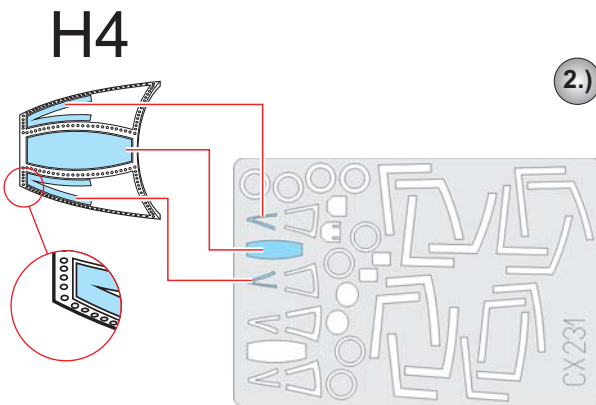

2.)

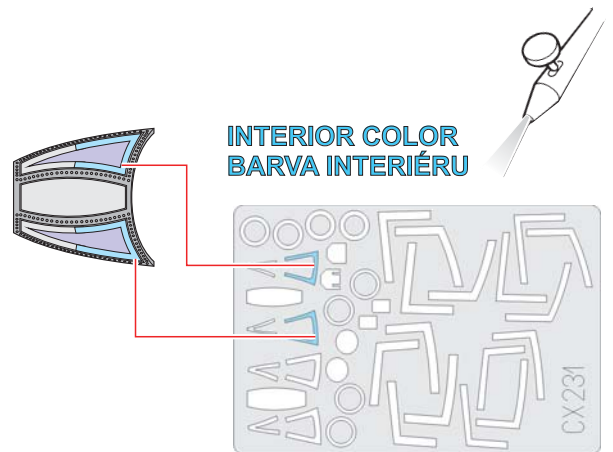

3.)

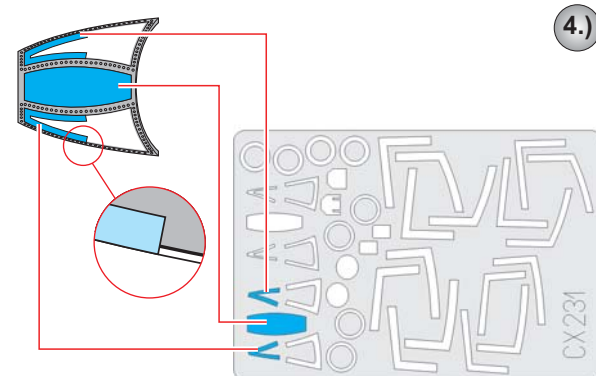

4.)

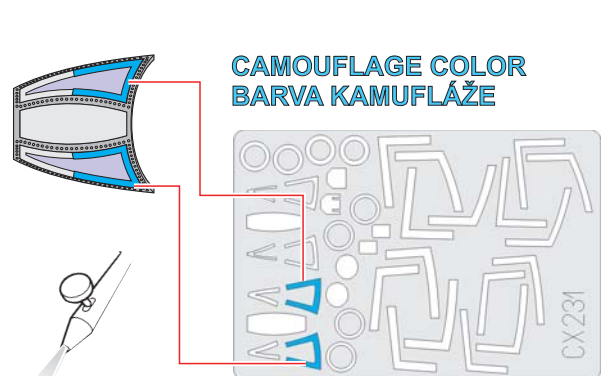

# H6

1.)

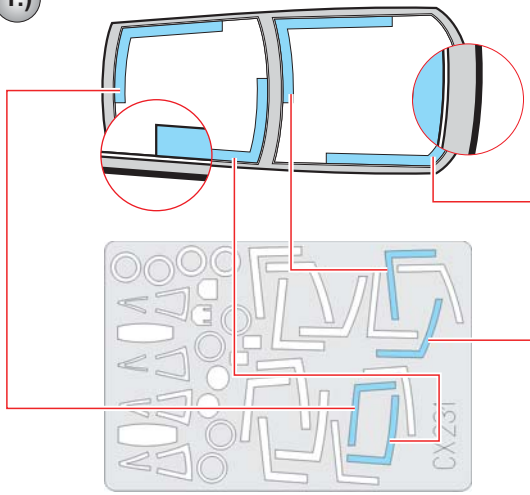

2.)

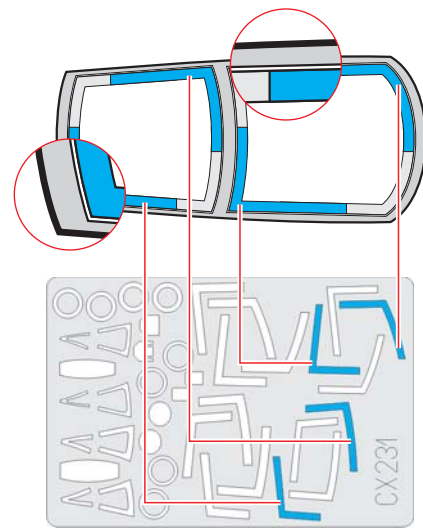

3.)

**INTERIOR COLOR  
BARVA INTERIÉRU**

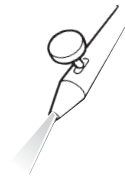
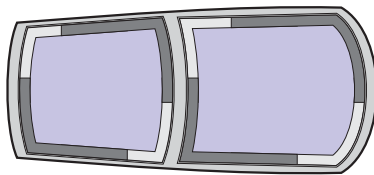

4.)

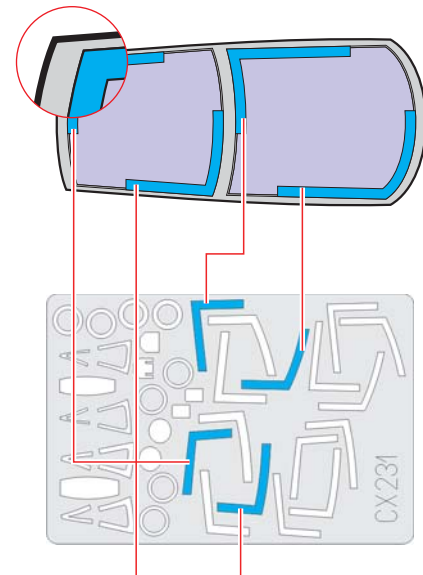

5.)

**CAMOUFLAGE COLOR  
BARVA KAMUFLÁŽE**

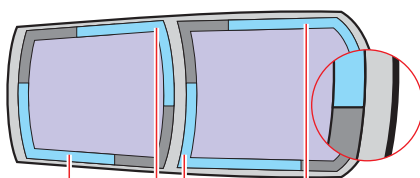

6.)

# H6

