

eduard
MASK

He 111P

The die-cut mask for accurate canopy frame painting of the
Hasegawa 1/72 KIT

1/72

CX 106

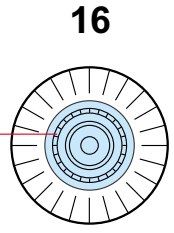
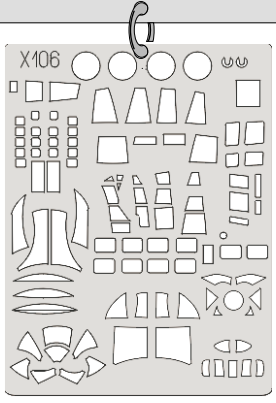

2 pcs.

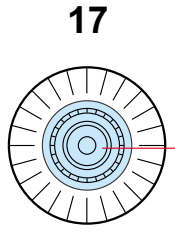

2 pcs.

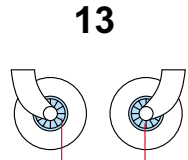

13



LIQUID MASK

REFERENCES:

Aero Detail No.18 - Heinkel He 111
Modelpres Publ. - Heinkel He 111
Replic No.40 12/1994

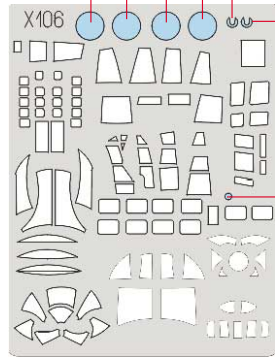

N10

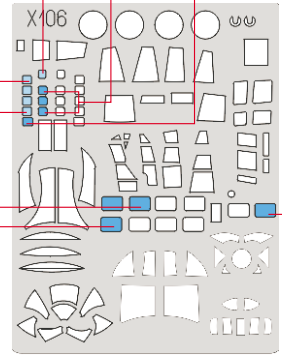
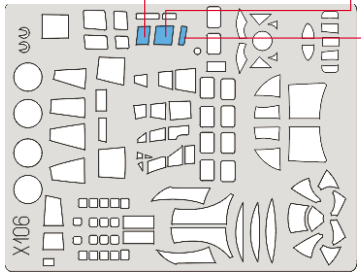
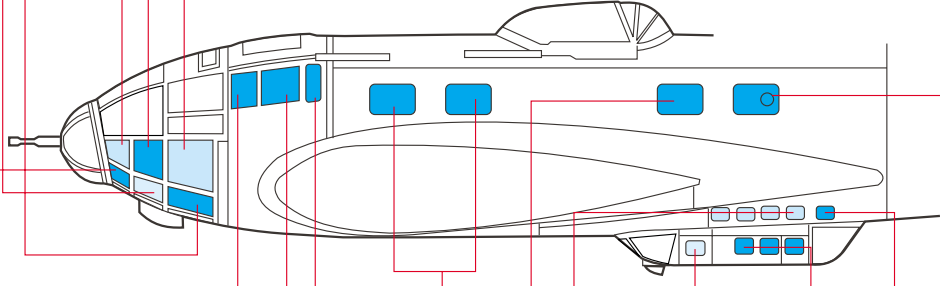
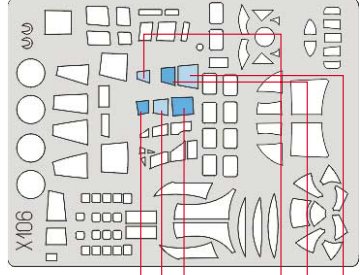

1.)

2.)

1.)

2.)

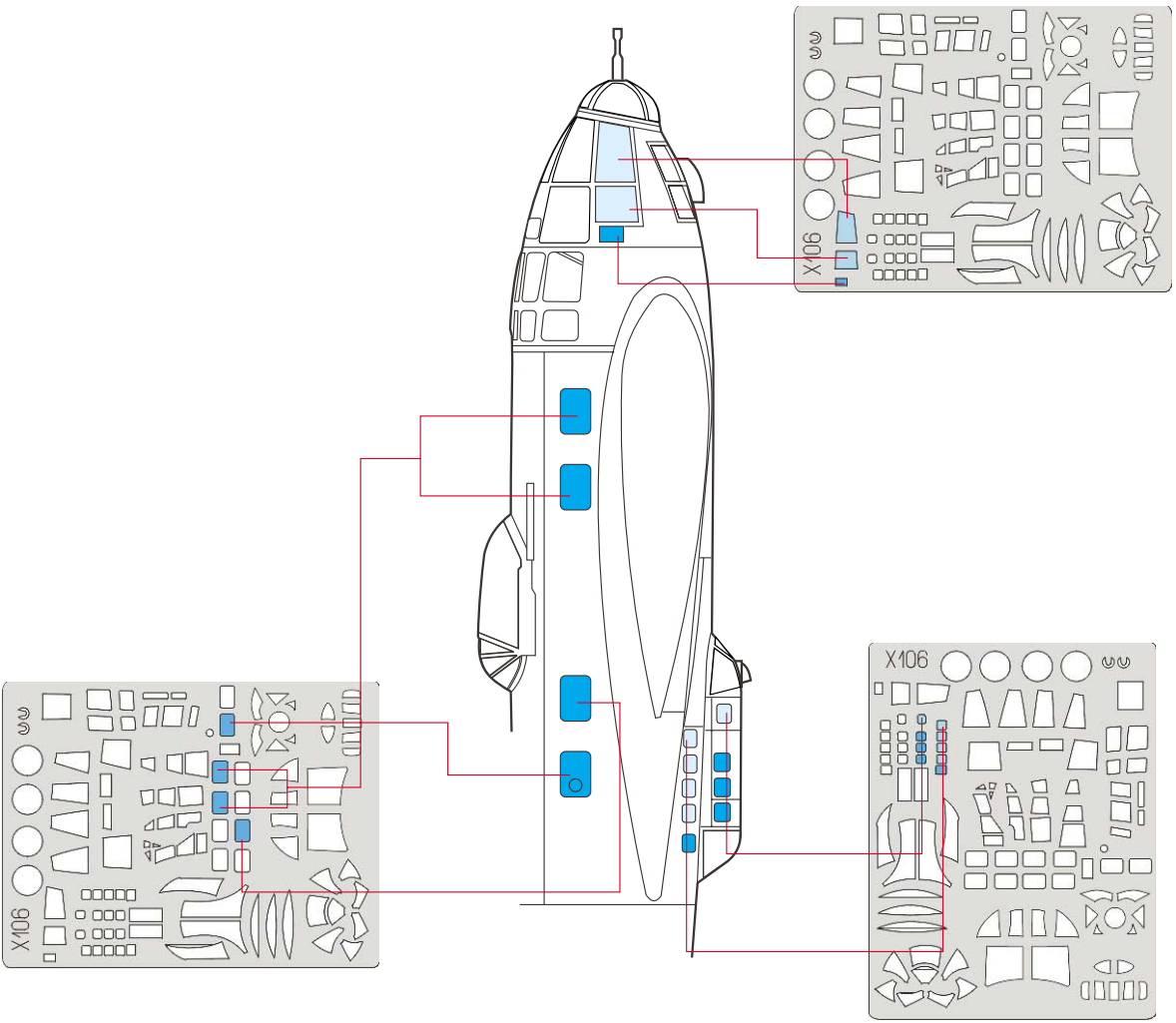
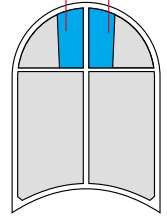
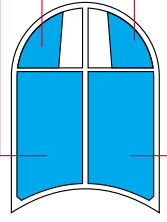
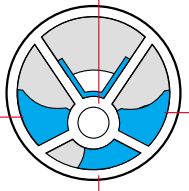
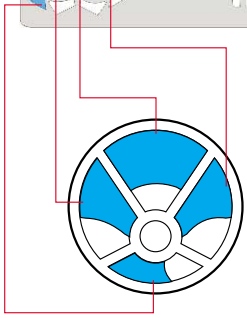
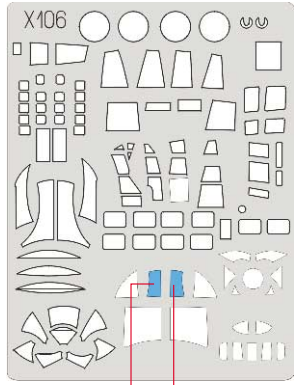
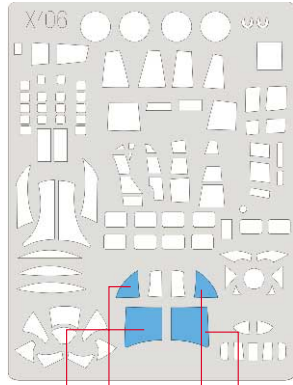
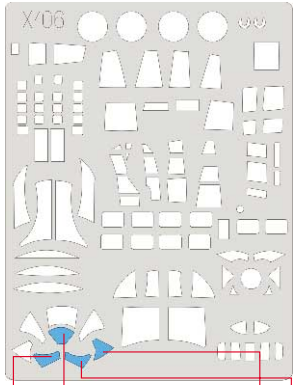
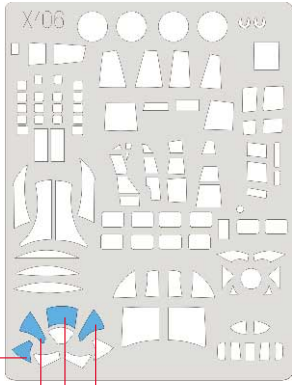

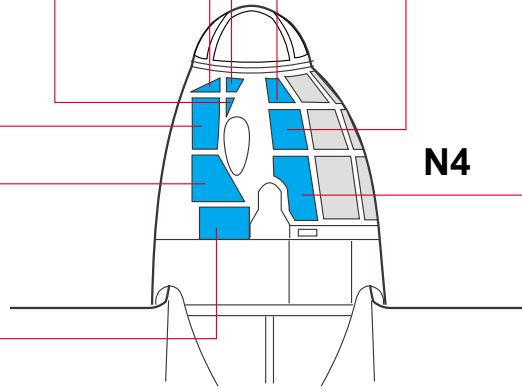
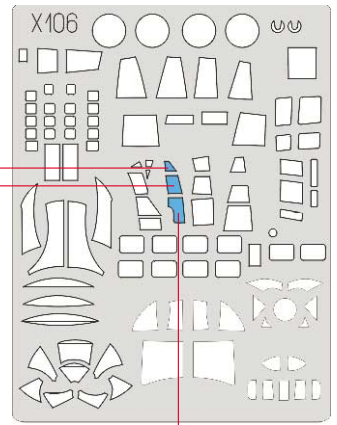
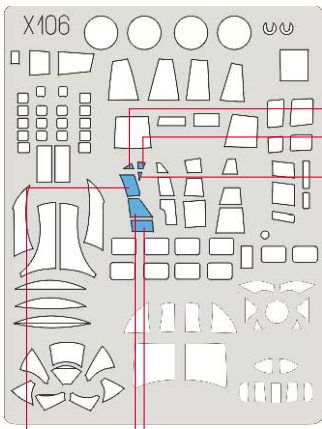

1.)

2.)

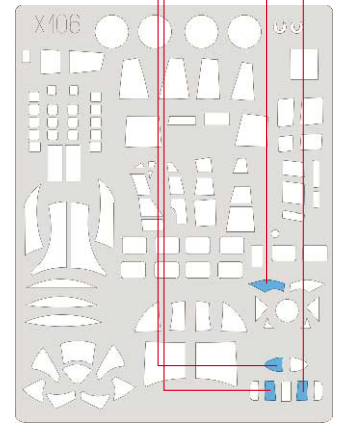
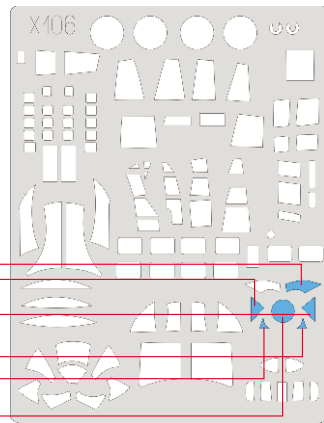
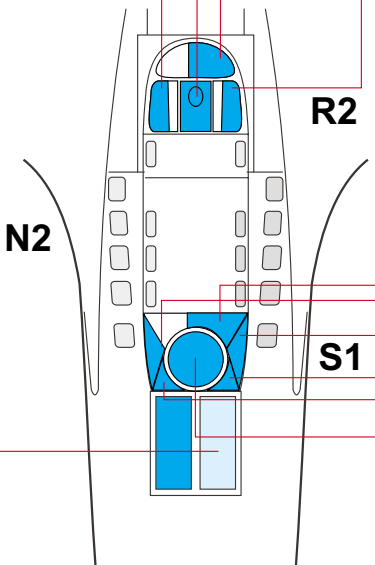
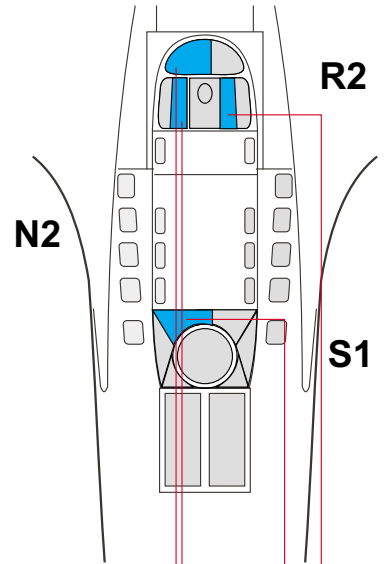
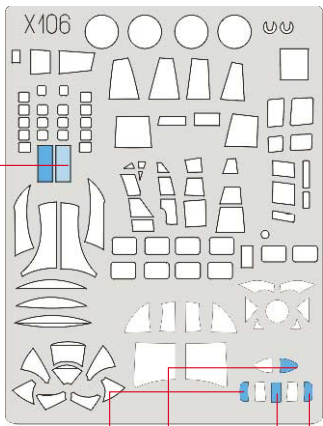

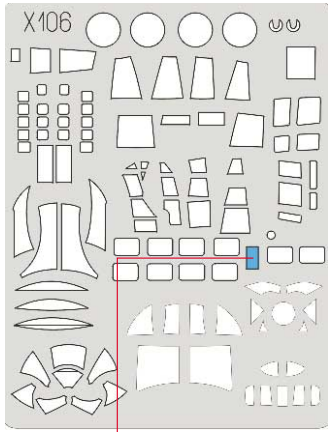

LIQUID MASK

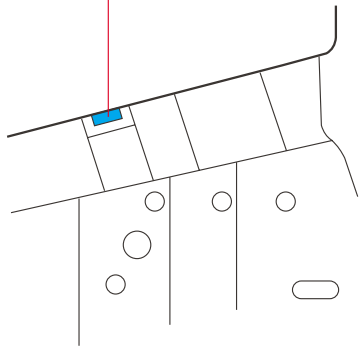
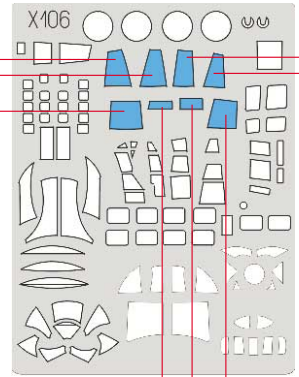

N3

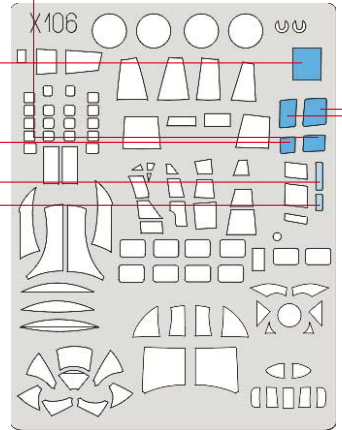
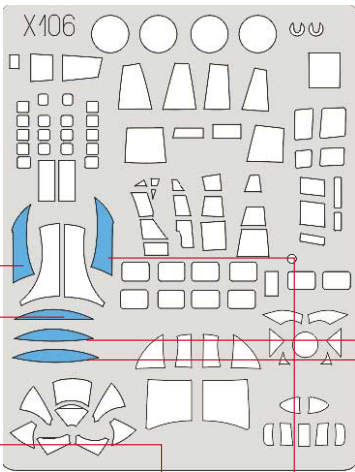
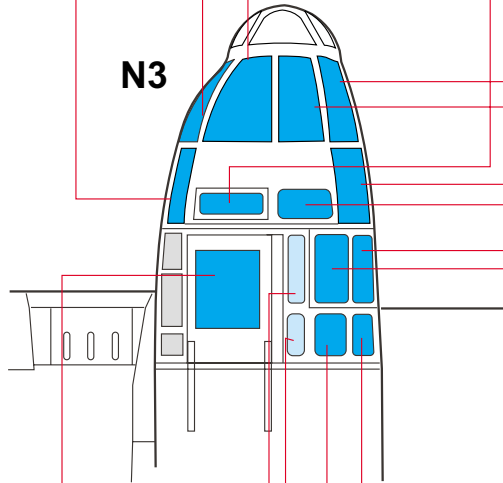

1.)

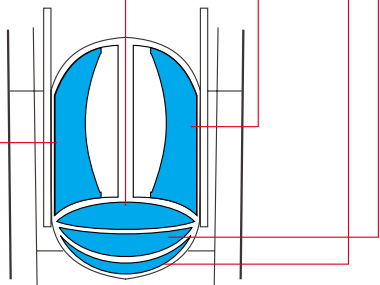

2.)

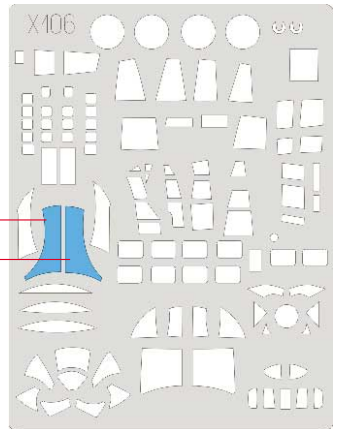
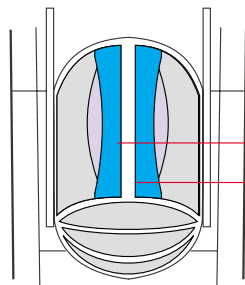

T3