

eduard
MASK

Mosquito Bomber 1/72

The die-cut mask for accurate canopy frame painting of the
Hasegawa 1/72 KIT

CX 040

 - LIQUID MASK

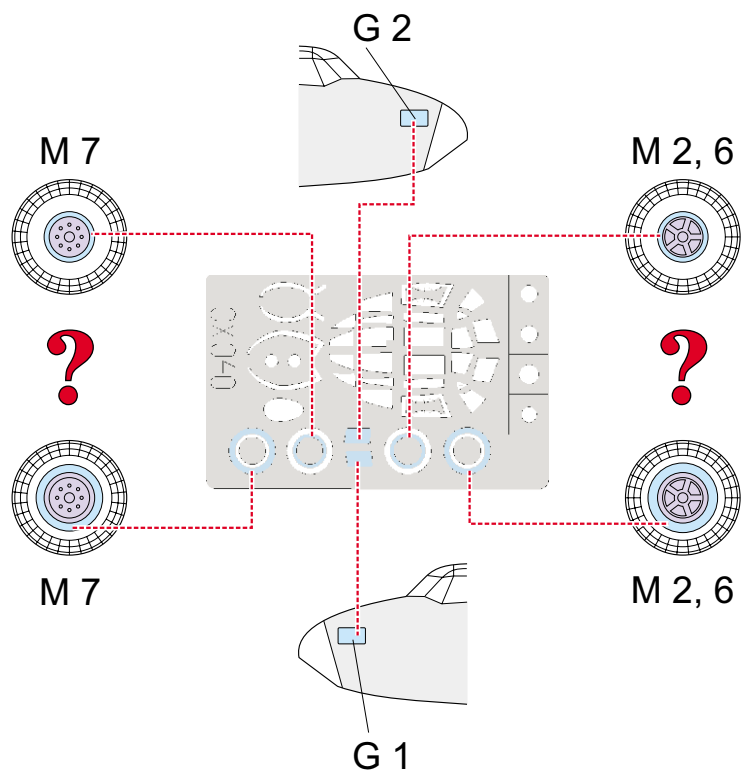
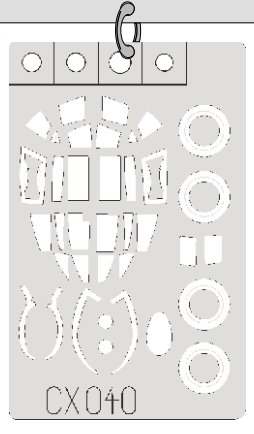

REFERENCES:
 SQUADRON SIGNAL
 PUBLICATION 5515,
 WALK AROUND MOSQUITO
 SAM PUBLICATION,
 MODELLERS DATAFILE 1,
 THE DE HAVILLAND MOSQUITO

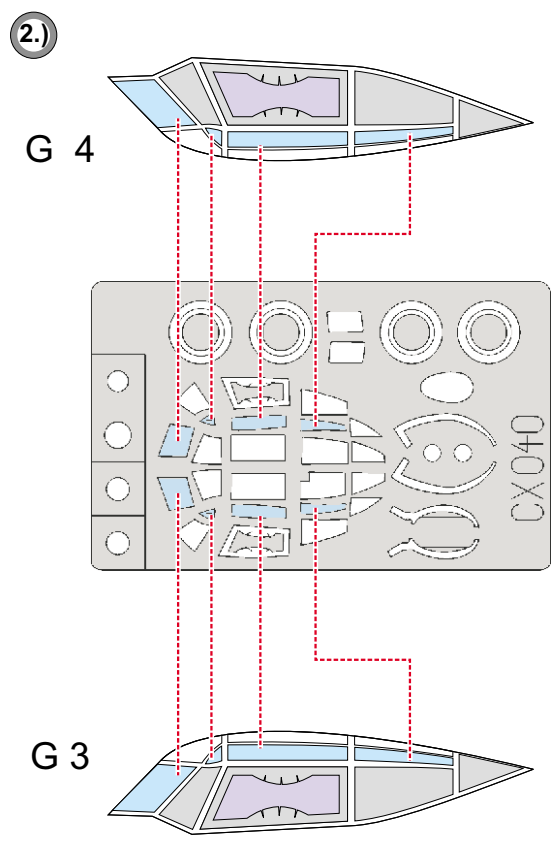
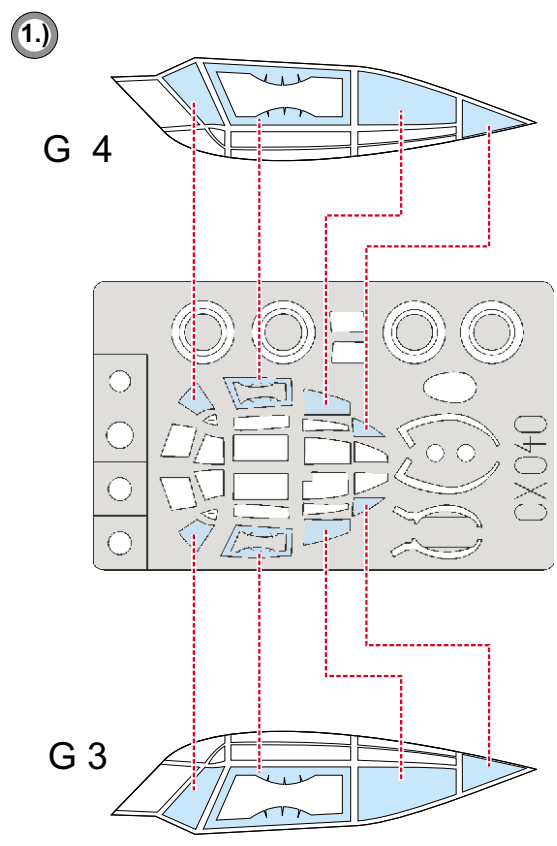

3.)

G 3, 4

G 3, 4

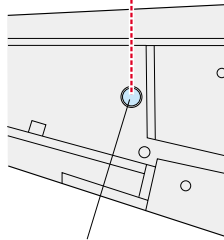
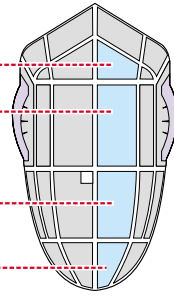
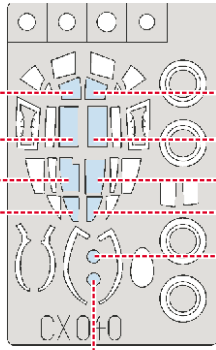
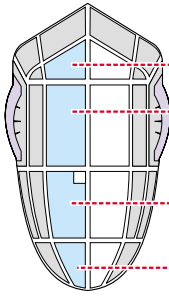

K 1

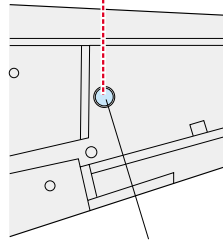

K 1

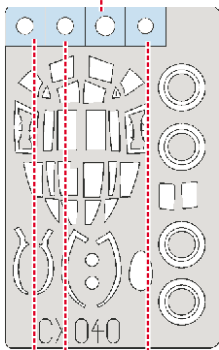

CX040

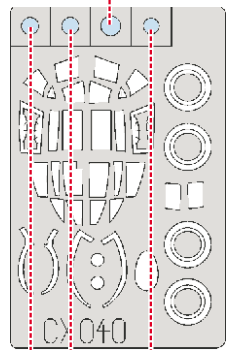

CX040

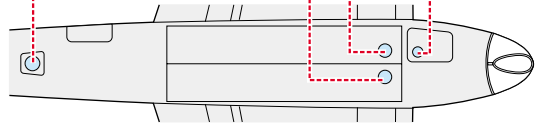
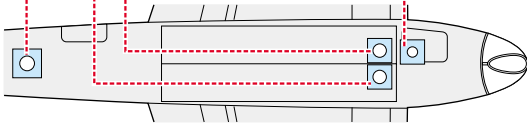

1.)

G 5

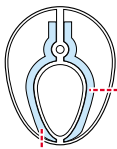

2.)

G 5

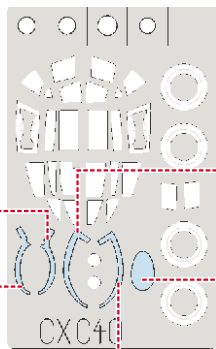
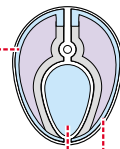

CX040