

eduard  
MASK

# Do 217K 1/72

The die-cut mask for accurate canopy frame painting of the  
*Italeri 1/72 KIT*

CX 032

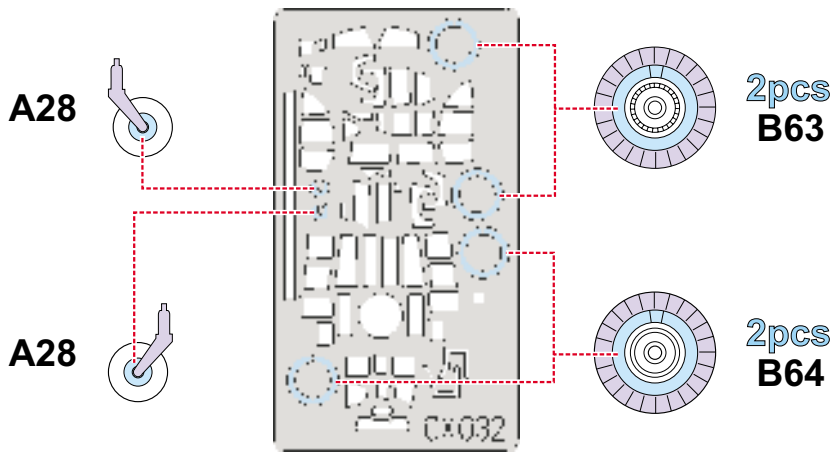

LIQUID MASK 

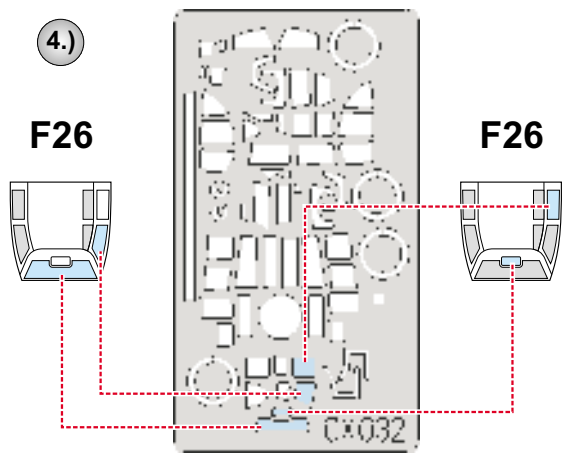
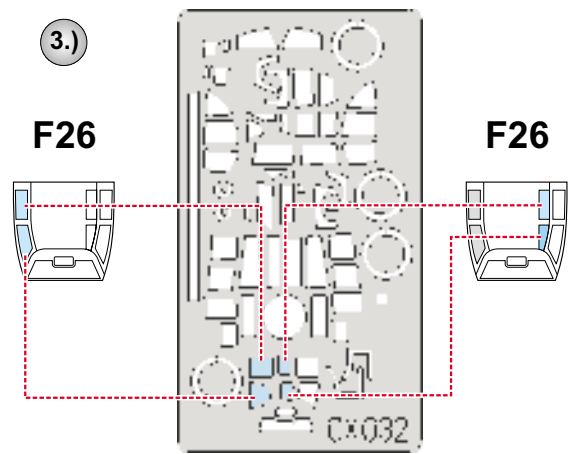
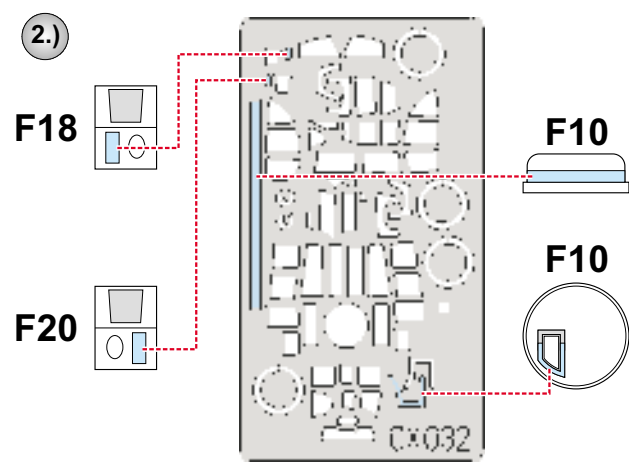
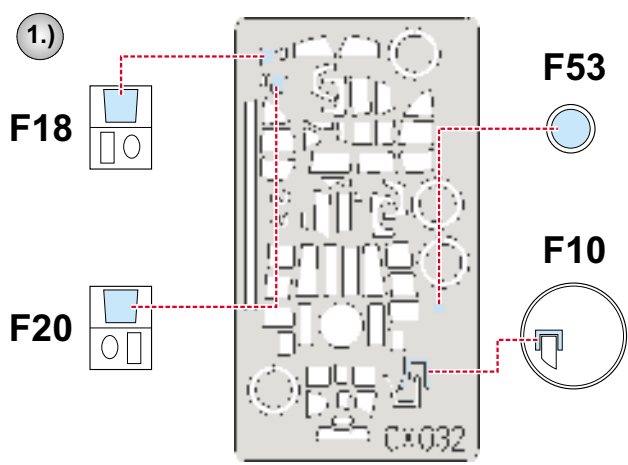

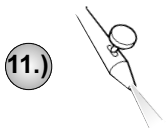
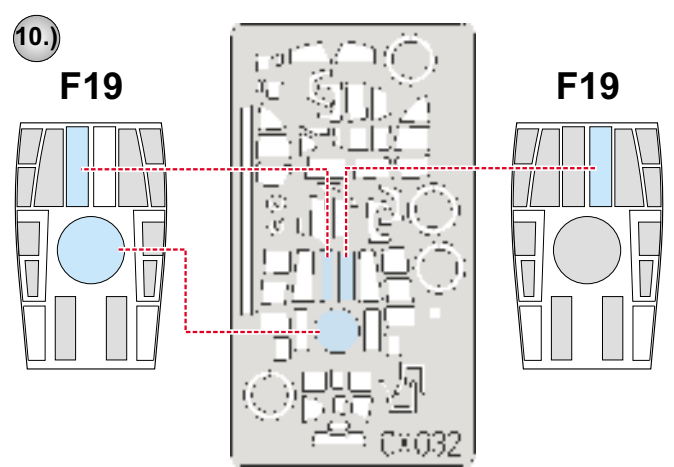
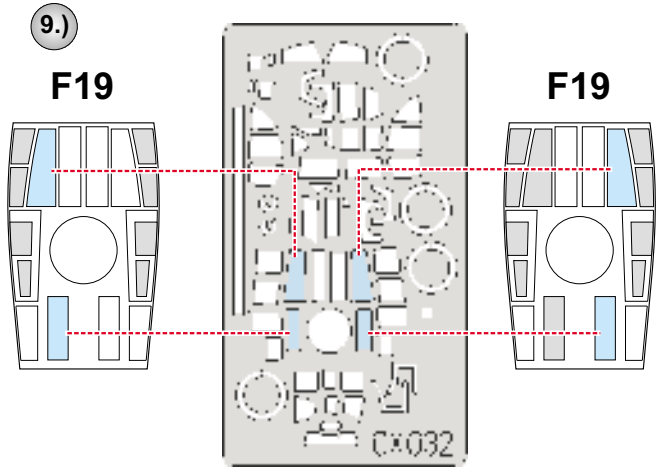
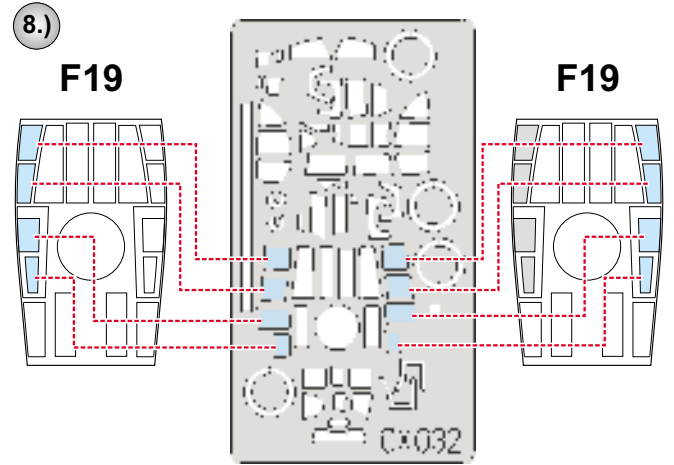
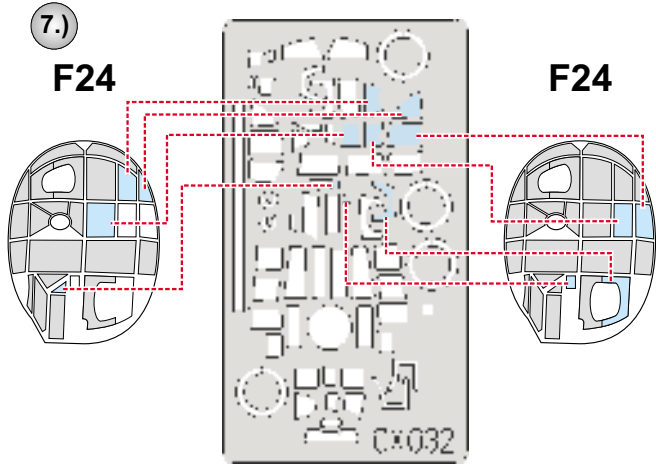
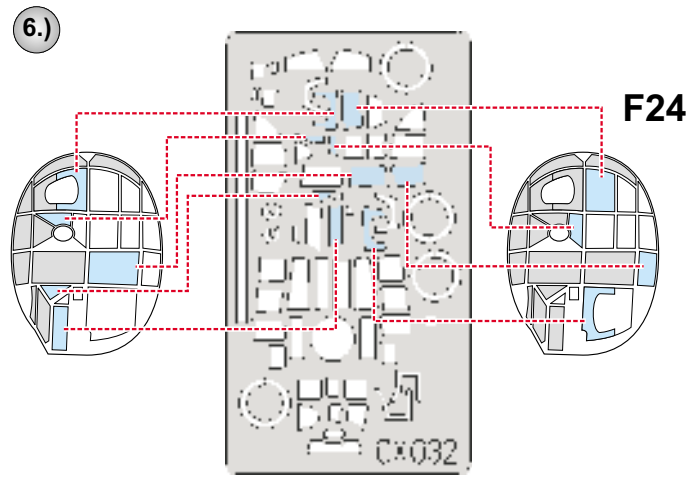
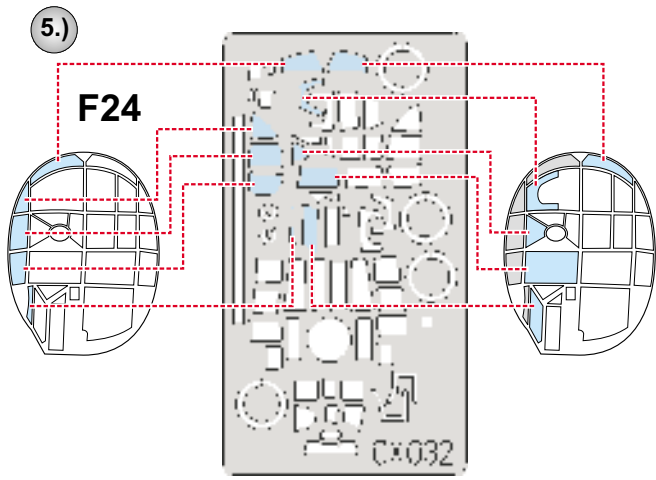

**INTERIOR  
COLOR**

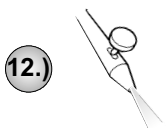

**CAMOUFLAGE  
COLOR**

**F24**

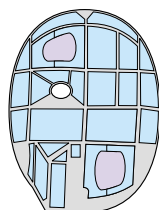

**F19**

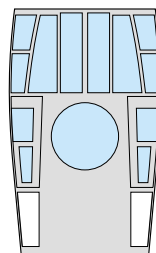

**F18**



**F20**



**F10**

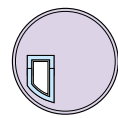

**F10**

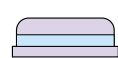

**F26**

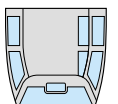

**LIQUID MASK**