

eduard
MASK

JX 150

He 111H-6 1/32

The die-cut mask for accurate canopy frame painting of the
Revell scale 1/32 KIT



JX150-A

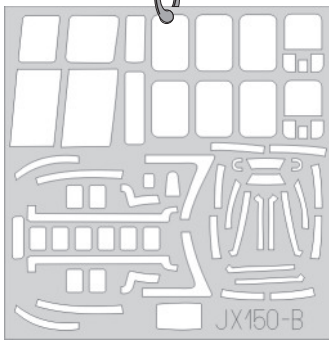

JX150-B

307



305

1.)

2x

149

LIQUID MASK

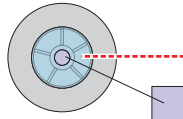

172

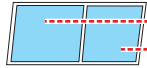

94

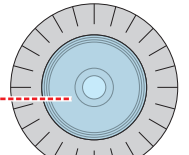

4x

174

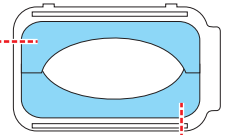

175

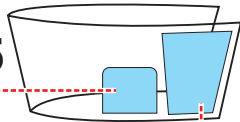

175

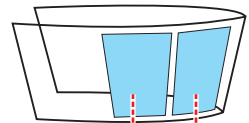

2.)

177

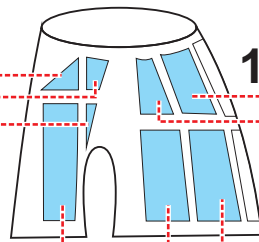

3.)

177

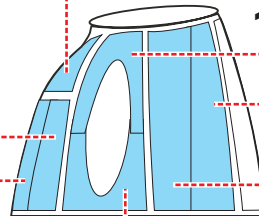

4.)

177

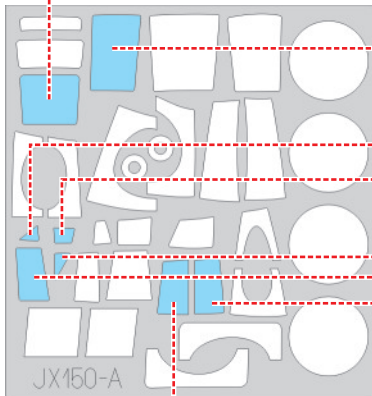
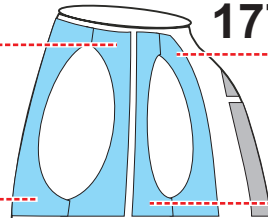

JX150-A

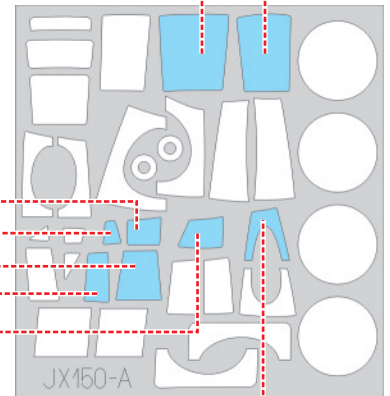

JX150-A

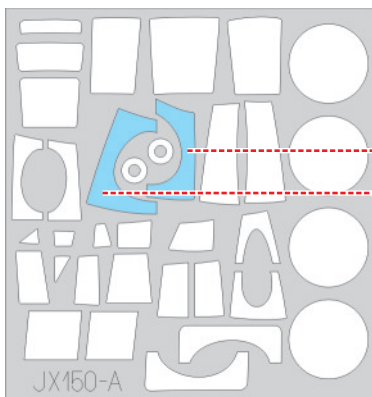

JX150-A

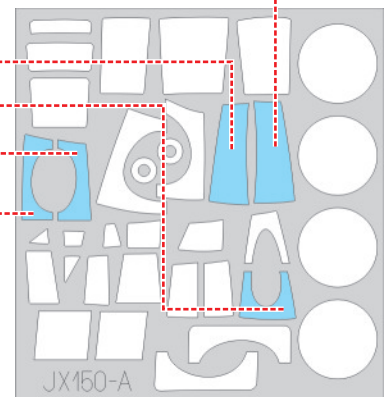

JX150-A

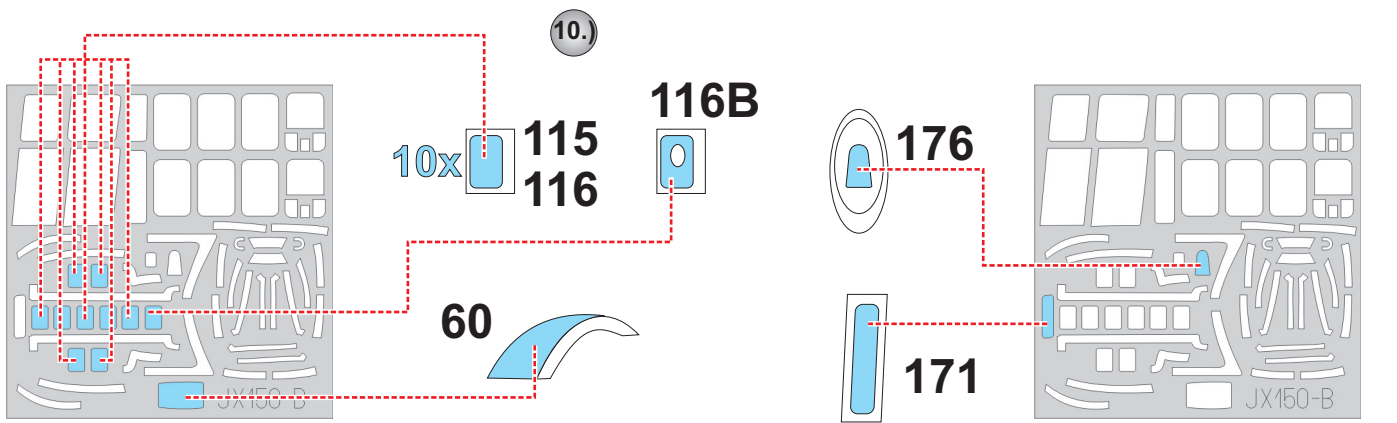
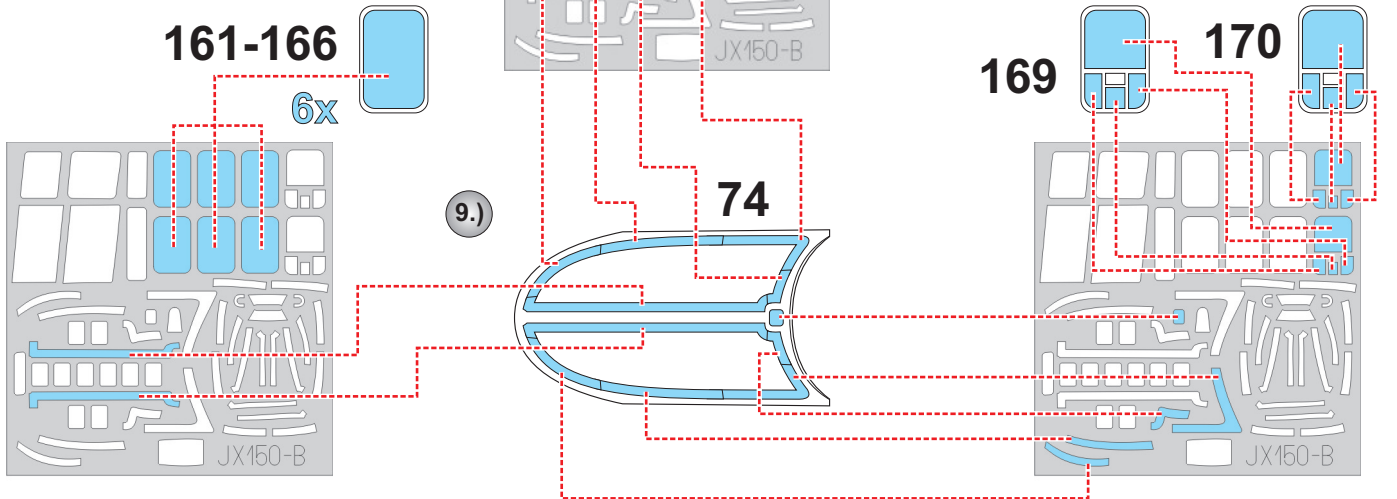
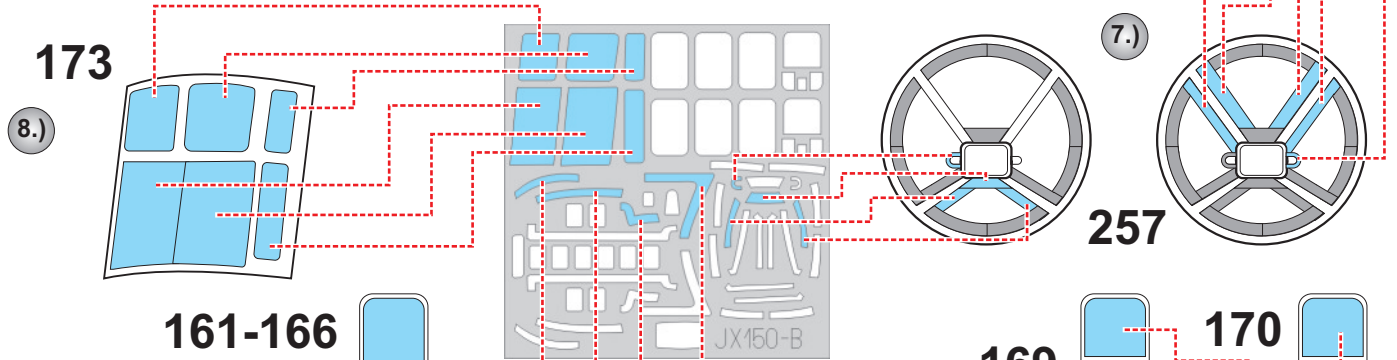
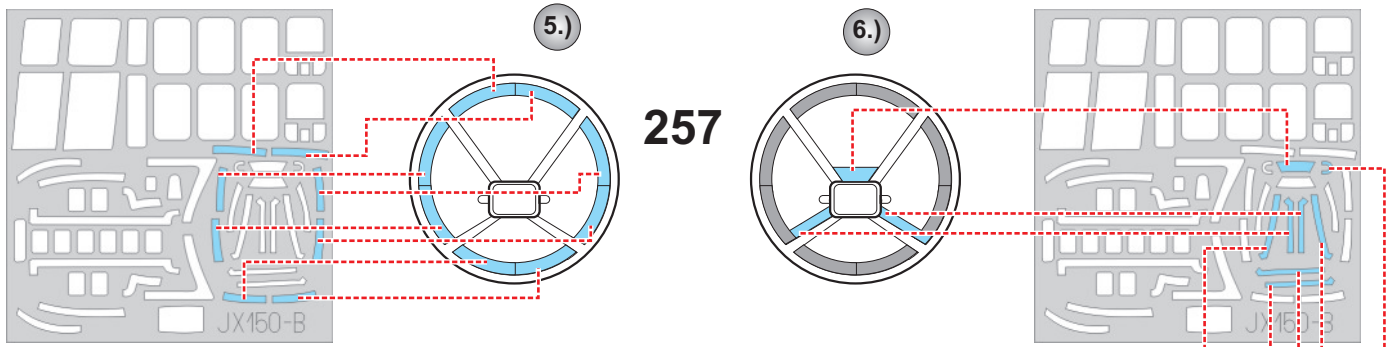

11. LIQUID MASK ■

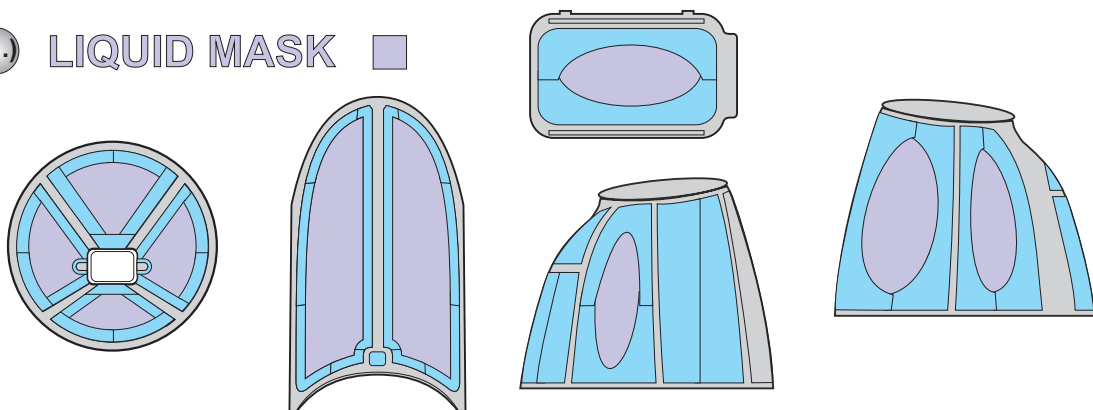

eduard
MASK

JX 150

He 111H-6 1/32

The die-cut mask for accurate canopy frame painting of the
Revell scale 1/32 KIT

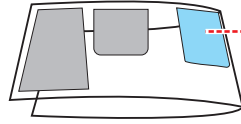
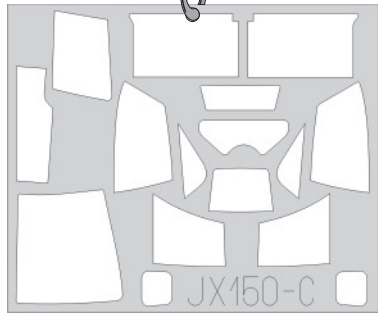

175

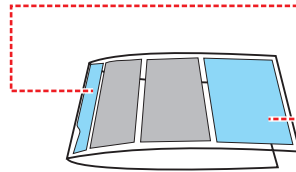
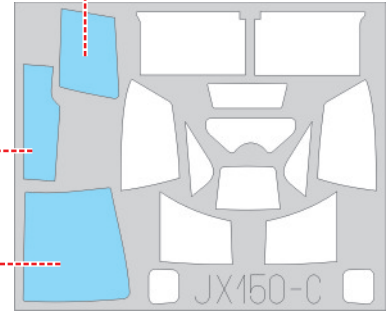

175

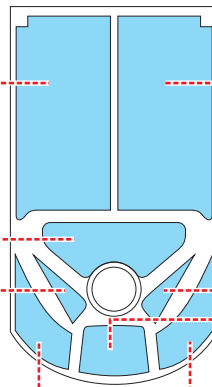
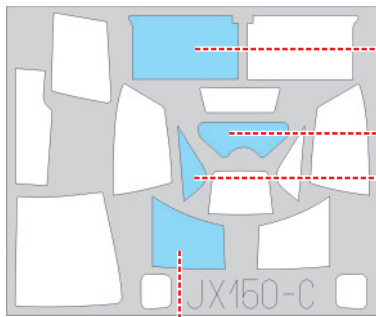

344

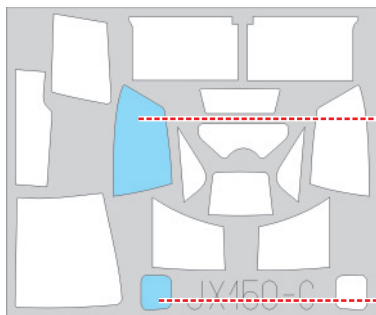
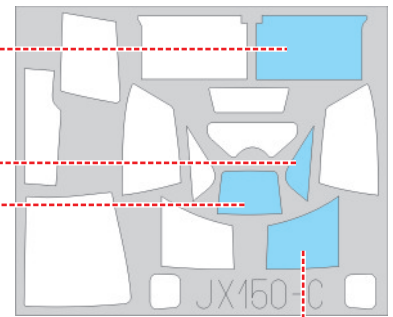

111

