

635 040 WWII German Jerry Cans



1/35 scale



R59 2pcs.



R60 2pcs.



R61 2pcs.



R62 2pcs.



R63 2pcs.



R64 2pcs.

COLOURS

GSI Creos (GUNZE)			Mr.METAL COLOR	
AQUEOUS	Mr.COLOR			
[H 32]	[C 40]	FIELD GRAY		

This product contains metal and resin detail parts for upgrading scale plastic models. When selecting this set make sure that it is for the kit mentioned in product name as these sets are made specifically for that kit. When upgrading the model some cutting or corrections may be necessary for parts to fit accurately. **WARNING!** This set contains small and sharp parts. Work carefully in a ventilated and well-lit room. Safety glasses are recommended. This product is not suitable for children below 14 years of age.

Tento výrobek obsahuje leptané a odlévané detaily pro úpravu a vylepšení plastického modelu. Při výběru sady kovových detailů zkontrolujte, zda je určena pro model, který chcete upravit. Model, pro který je sada určena, je uveden u názvu výrobku. Pro přesnou aplikaci kovových a odlévaných dílů může být zapotřebí upravit díly upravovaného modelu. **POZOR!** Sada obsahuje malé ostré díly. Pracujte ve větrané a dobře osvětlené místnosti.



435 21 Obrnice 170
Czech Republic

www.eduard.com

10,95









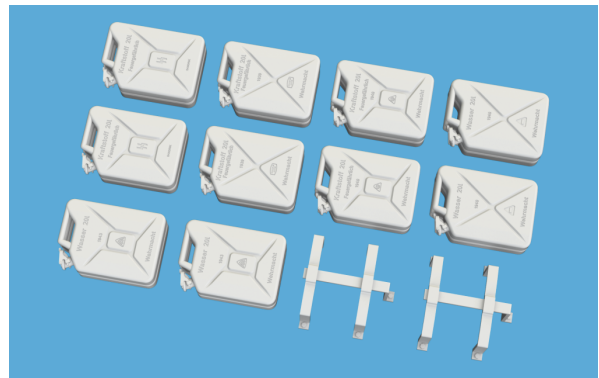
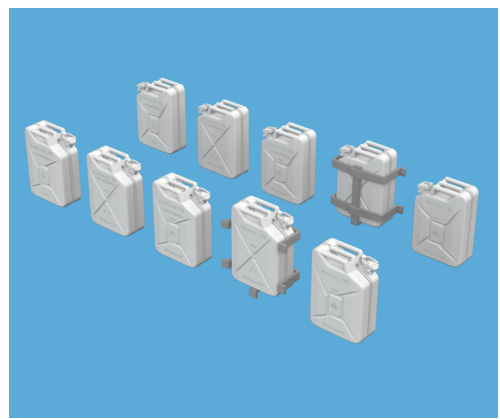

635 040

WWII German Jerry Cans

1/35



BEST BRASS AROUND!

-  REMOVE
ODSTRANIT
-  BEND
OHNOUT
-  GRIND
OBROUSIT
-  OPTION
VOLBA
-  DRILL A HOLE
VRTAT OTVOR
-  REPLACE
NAHRADIT
-  SYMMETRICAL ASSEMBLY
SYMETRICKÁ MONTÁŽ
-  SCRIBE THE PANEL AND HOLES
RYTI
-  REVERSE SIDE
OTOČIT

