

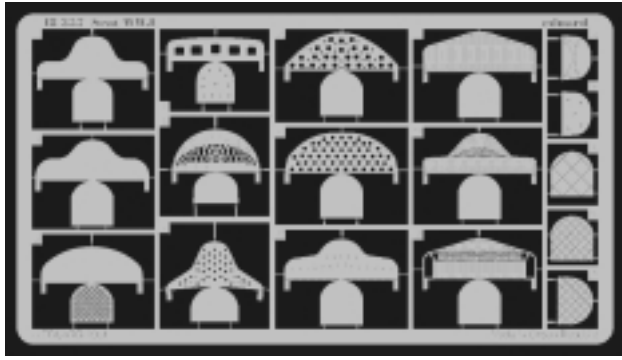







Seats WW.I

eduard

48 357



-  SYMMETRICAL ASSEMBLY
SYMETRICKÁ MONTÁŽ
-  REMOVE
ODSTRANIT
-  BEND
OHNOUT
-  REPLACE
NAHRADIT
-  GRIND
OBROUSIT
-  OPTION
VOLBA

 ORIGINAL KIT PARTS
PŮVODNÍ DÍLY STAVEBNICE

 PHOTO-ETCHED PARTS
LEPTANÉ DÍLY

 PARTS TO BE REMOVED
DÍLY K ODSTRANĚNÍ

Step 1

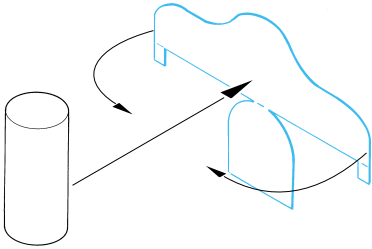

Step 2

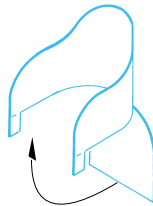

Step 3

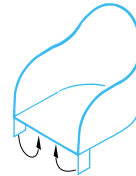

Step 4

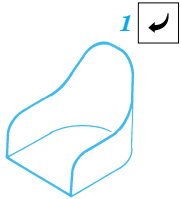
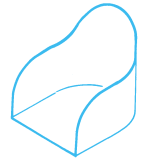

Pfalz D.III a

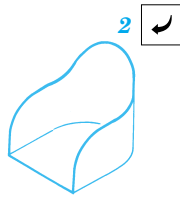

Albatros D.III , D.V

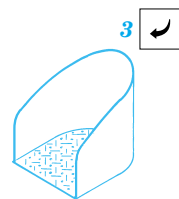

Spad VII

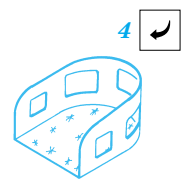

Hannover CL.III

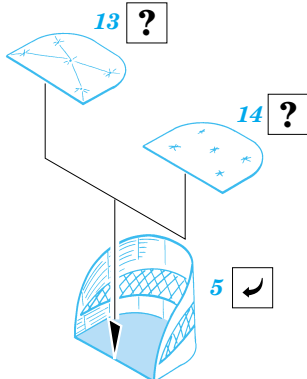

Bristol M.1

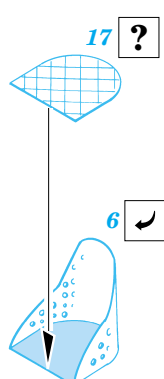

Nieuport Ni 17

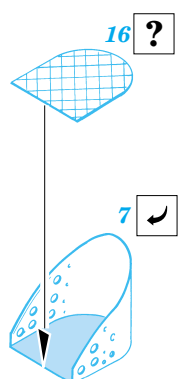

Nieuport Ni 11

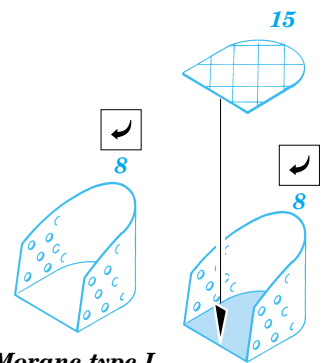

Morane type L

Hanriot HD 2

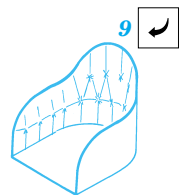

AEG C.IV

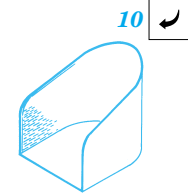

RAF Re.8

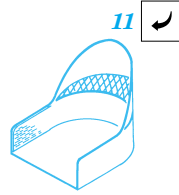

Sopwith Snipe

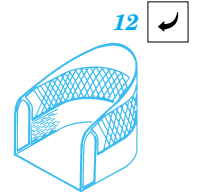

Be.2C