

1

★ APPLY EXPRESS MASK AND PAINT BEFORE GLUING  
POUŽIT EXPRESS MASK NABARVIT PŘED SLEPENÍM

◐ SYMMETRICAL ASSEMBLY  
SYMETRICKÁ MONTÁŽ

✂ REMOVE  
ODSTRANIT

▨ GRIND  
OBROUSIT

⚪ DRILL A HOLE  
VRTAT OTVOR

④ 3D DECAL PARTS  
3D OBTISKY

① PRE-PAINTED ETCHED PARTS  
LEPTANÉ BAREVNÉ DÍLY

① ETCHED PARTS  
LEPTANÉ NEBAREVNÉ DÍLY

① ORIGINAL KIT PARTS  
PŮVODNÍ DÍLY STAVEBNICE

↪ BEND  
OHNOUT

❓ OPTION  
VOLBA

Ⓜ REPLACE  
NAHRADIT

↺ REVERSE SIDE  
OTOČIT

■ ORIGINAL KIT PARTS  
PŮVODNÍ DÍLY STAVEBNICE

■ COLORED 3D DECAL PARTS  
BAREVNÉ 3D OBTISKY

■ PHOTO-ETCHED PARTS  
LEPTANÉ DÍLY

■ SKIM / SAND OFF  
OBROUSIT

■ REMOVE / CUT OFF  
ODSTRANIT

■ FILL  
TMELIT

3DL 72069

B-24J

1/72

detail set for 1/72 HASEGAWA kit • sada detailů pro stavebnici 1/72 HASEGAWA

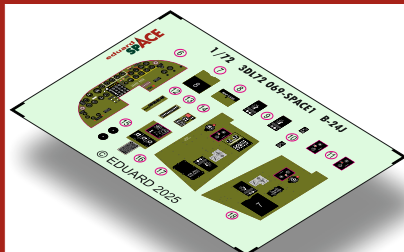

eduard  
SPACE

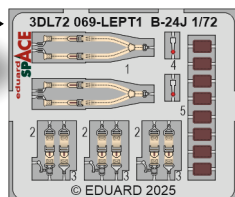

2

## 3D decals

•Soak the decal in the warm water for couple of seconds and after its separation from the backing paper position it on the model.

•To increase decal's adherence use the white glue, Mr. Mark Setter or apply to the glossy surface.

•Leaving decal in the water for too long can cause its swelling and distortion.

## PE parts

•Use cyanoacrylate glue to attach.

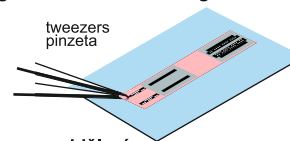

## 3D decals

•Vložte na několik vteřin do teplé vody a po oddělení od podkladového papíru naneste na model.

•Pro zvýšení přilnavosti lze použít disperzní lepidlo, Mr. Mark Setter či obtisk nanášet na lesklý povrch.

•Příliš dlouhé vystavení 3D obtisku vodě může způsobit jeho nabobtnání.

## PE parts

•K lepení použijte kyanoakrylátové lepidlo.

A

↪ 3

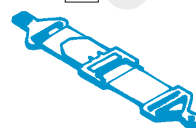

B

1.)

↪ 2

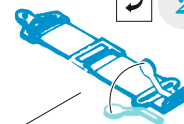

2.)



5

3.)

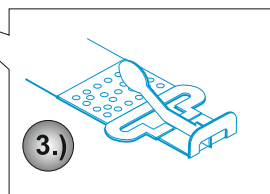

3

① ↪

2 sets

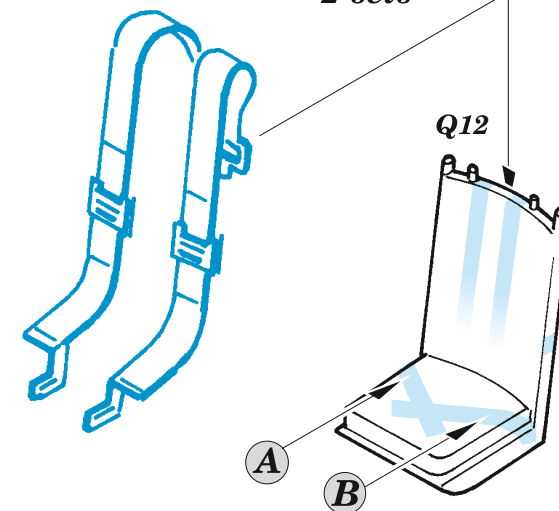

R27

