



# Seatbelts RFC WWI STEEL

1/32 scale detail set • sada detailů pro model 1/32

eduard

32 888

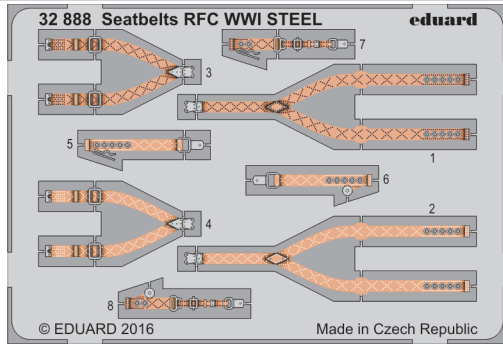

- APPLY EXPRESS MASK AND PAINT BEFORE GLUING  
POUŽIT EXPRESS MASK NABARVIT PŘED SLEPENÍM
- SYMETRICAL ASSEMBLY  
SYMETRICKÁ MONTÁŽ
- REMOVE  
ODSTRANIT
- GRIND  
OBROUSIT
- DRILL HOLE  
VRTÁT OTVOR
- COLORED ETCHED PARTS  
LEPTANÉ BAREVNÉ DÍLY
- ETCHED PARTS  
LEPTANÉ NEBAREVNÉ DÍLY
- ORIGINAL KIT PARTS  
PŮVODNÍ DÍLY STAVEBNICE
- BEND  
OHNOUT
- OPTION  
VOLBA
- REPLACE  
NAHRADIT

ORIGINAL KIT PARTS  
PŮVODNÍ DÍLY STAVEBNICE

PHOTO-ETCHED PARTS  
LEPTANÉ DÍLY

PARTS TO BE REMOVED  
DÍLY K ODSTRANĚNÍ

FILL  
TMELIT

**A**

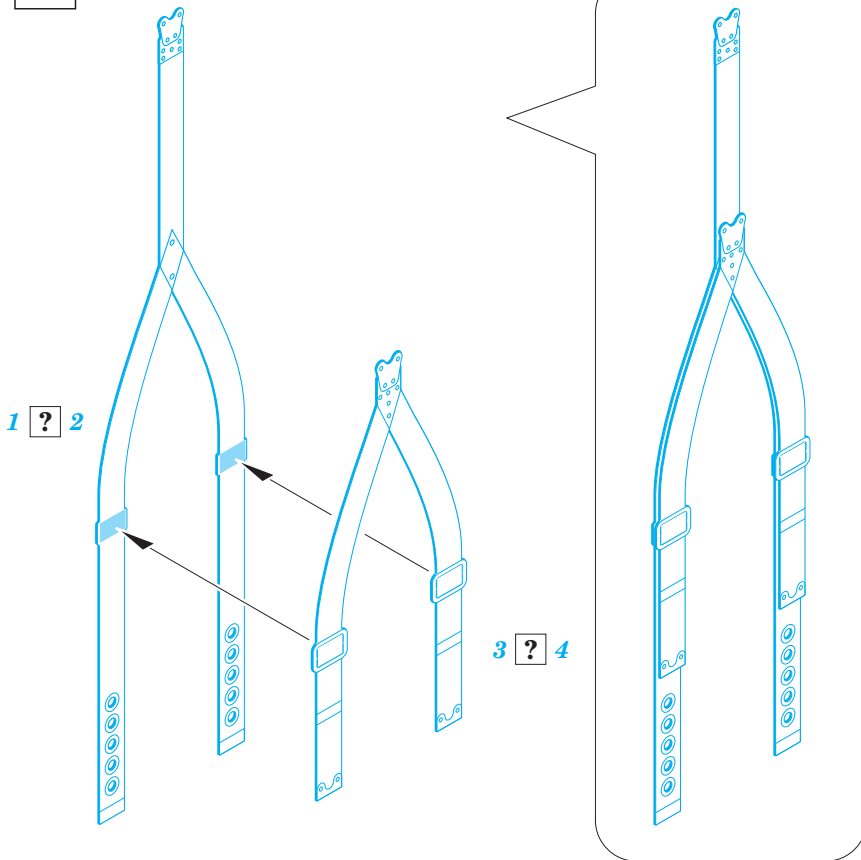

**B**

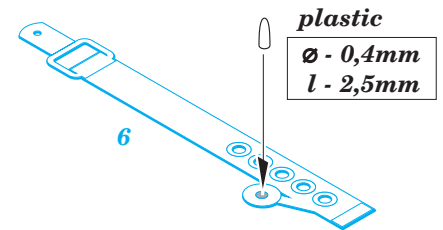

**C**

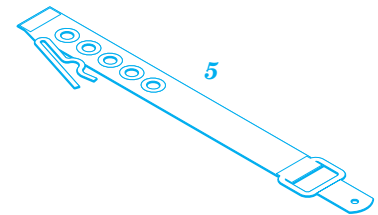

**D**

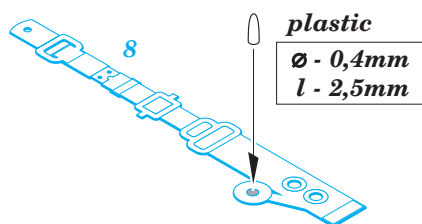

**E**

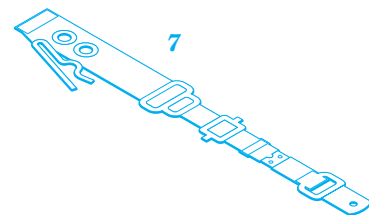

# EARLY

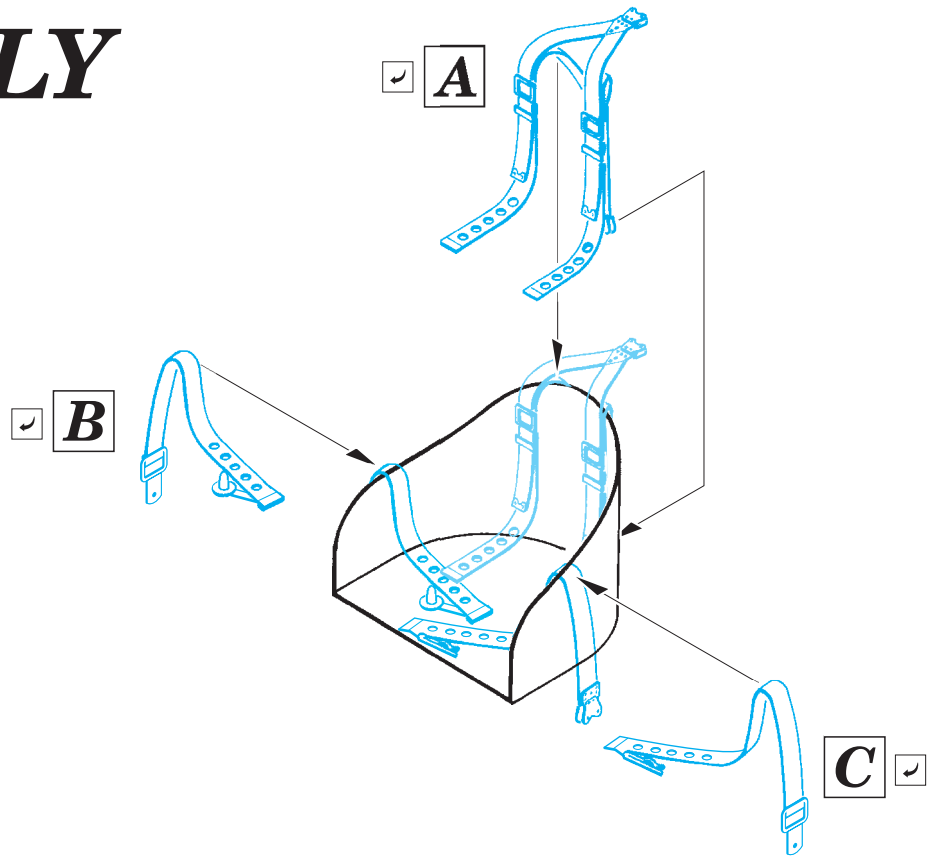

# LATE

