



T-28B/D Trojan exterior

eduard

detail set for 1/32 KITTY HAWK No. 32014 kit • sada detailů pro stavebnici 1/32 KITTY HAWK No. 32014

32 391

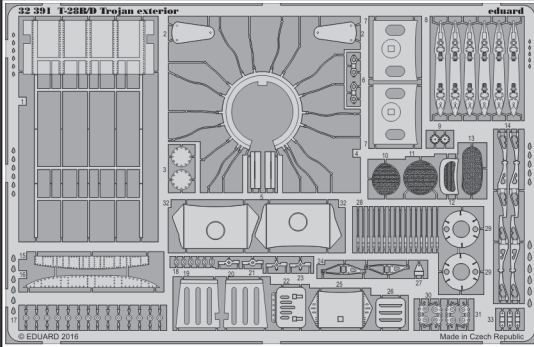

- ★ APPLY EXPRESS MASK AND PAINT BEFORE GLUING
POUŽIT EXPRESS MASK NABARVIT PŘED SLEPENÍM
- ☉ SYMMETRICAL ASSEMBLY
SYMETRICKÁ MONTÁŽ
- ☐ REMOVE
ODSTRANIT
- ☑ BEND
OHNOUT
- ▨ GRIND
OBROUSIT
- ⊙ ? OPTION
VOLBA
- ⊘ DRILL HOLE
VRTAT OTVOR
- Ⓜ REPLACE
NAHRADIT
- 1 COLORED ETCHED PARTS
LEPTANÉ BAREVNÉ DÍLY
- 1 ETCHED PARTS
LEPTANÉ NEBAREVNÉ DÍLY
- 1 ORIGINAL KIT PARTS
PŮVODNÍ DÍLY STAVEBNICE

ORIGINAL KIT PARTS
PŮVODNÍ DÍLY STAVEBNICE

PHOTO-ETCHED PARTS
LEPTANÉ DÍLY

PARTS TO BE REMOVED
DÍLY K ODSTRANĚNÍ

FILL
TMELIT

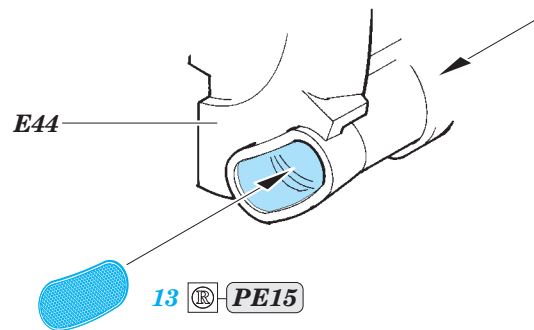
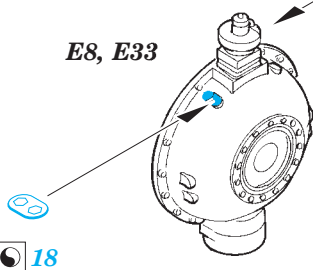
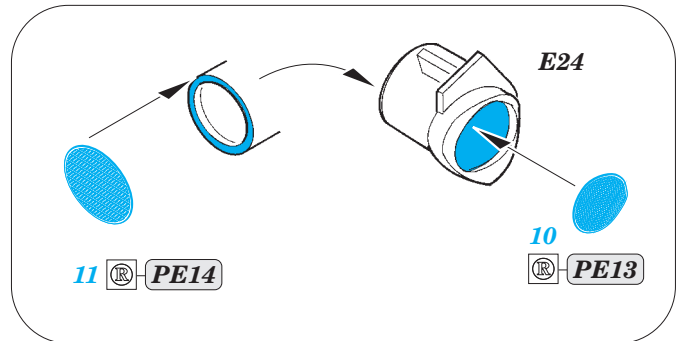
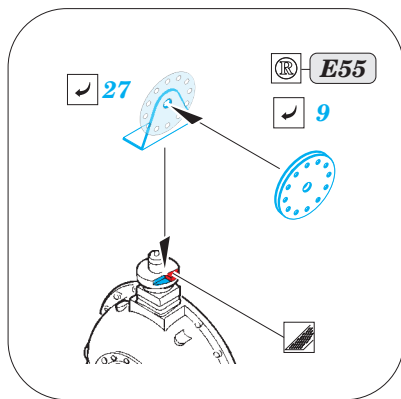
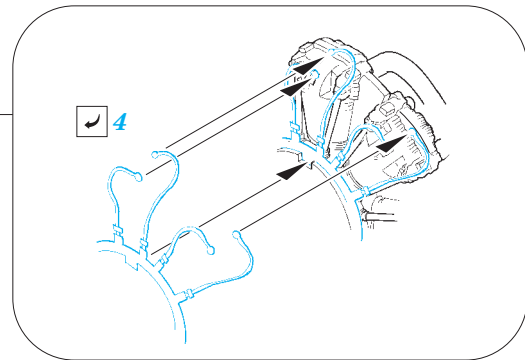
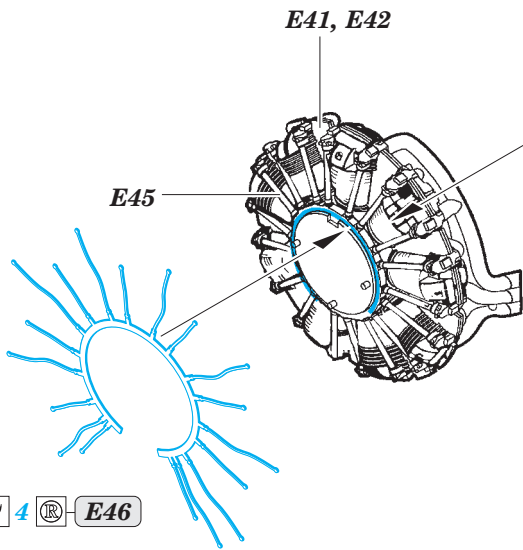

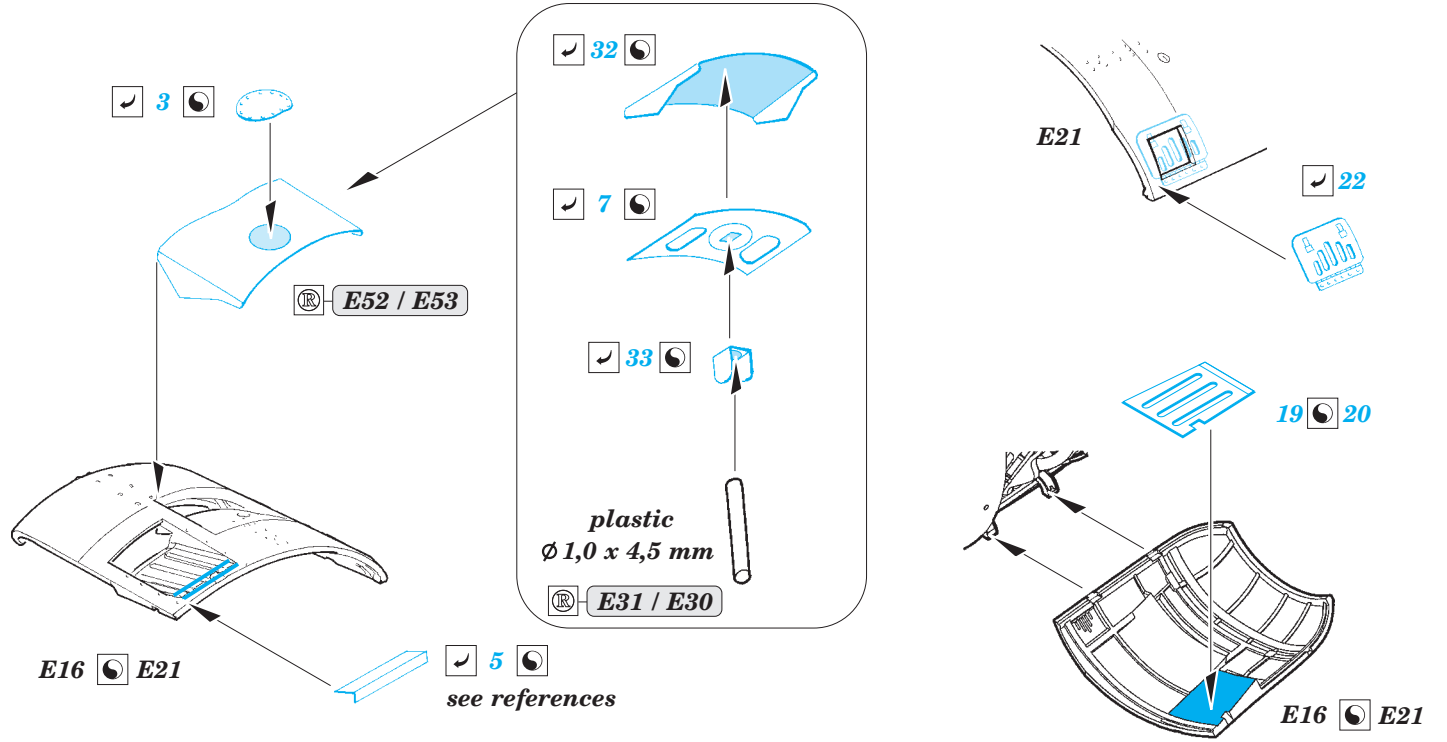
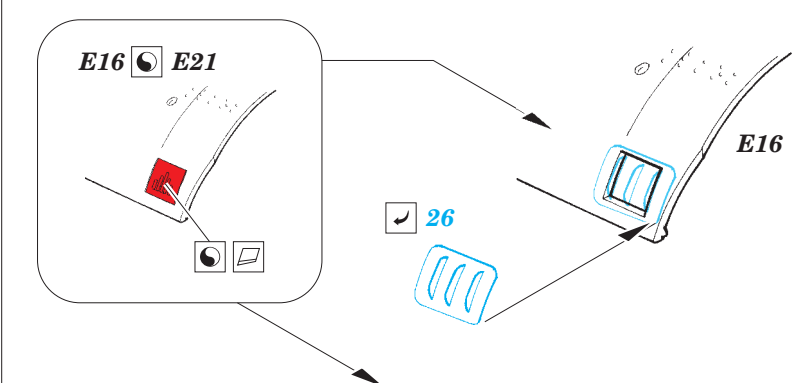
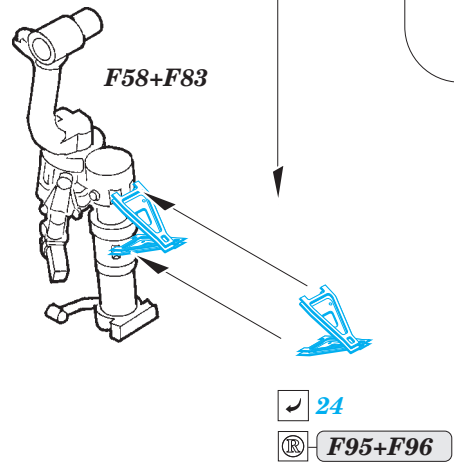
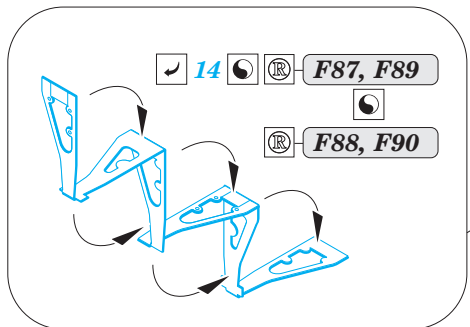
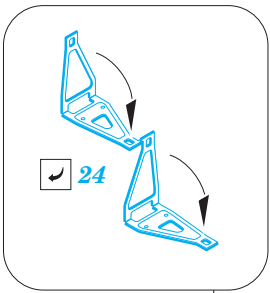
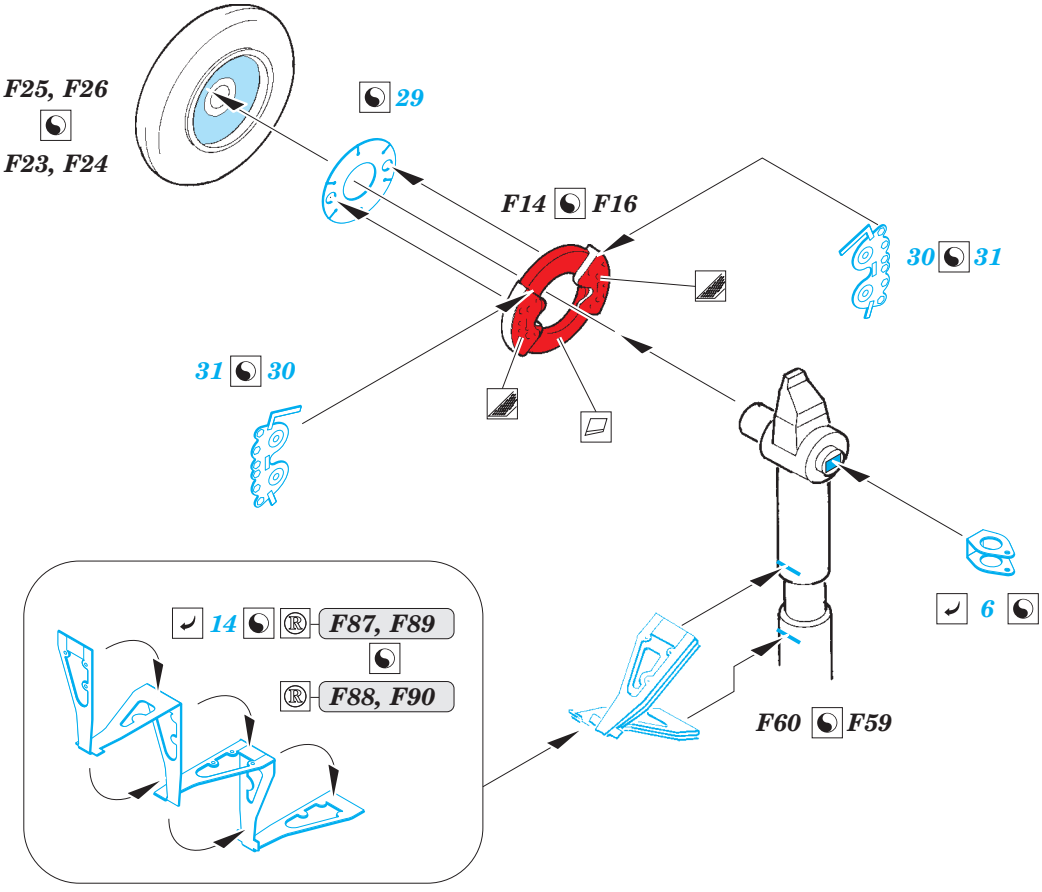

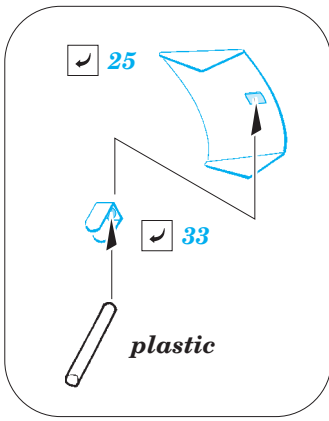

plastic
 Ø 1,0 x 3,5 mm

E29

