



Czech Hedgehog

1/72 scale detail set • sada detailů pro model 1/72

eduard

22 067

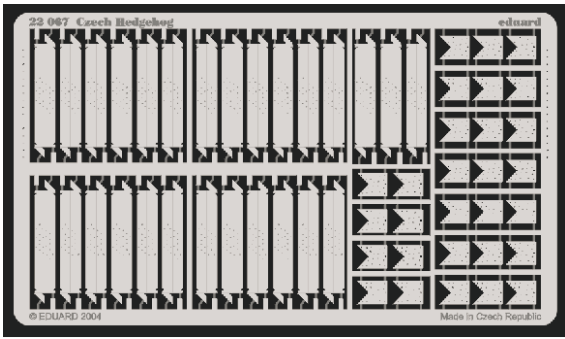

- APPLY EXPRESS MASK AND PAINT BEFORE GLUING
POUŽIT EXPRESS MASK NABARVIT PŘED SLEPENÍM
- SYMMETRICAL ASSEMBLY
SYMETRICKÁ MONTÁŽ
- REMOVE
ODSTRANIT
- GRIND
OBROUSIT
- DRILL HOLE
VRTAT OTVOR
- BEND
OHNOUT
- OPTION
VOLBA
- REPLACE
NAHRADIT

ORIGINAL KIT PARTS
PŮVODNÍ DÍLY STAVEBNICE
 PHOTO-ETCHED PARTS
LEPTANÉ DÍLY
 PARTS TO BE REMOVED
DÍLY K ODSTRANĚNÍ
 FILL
TMELIT

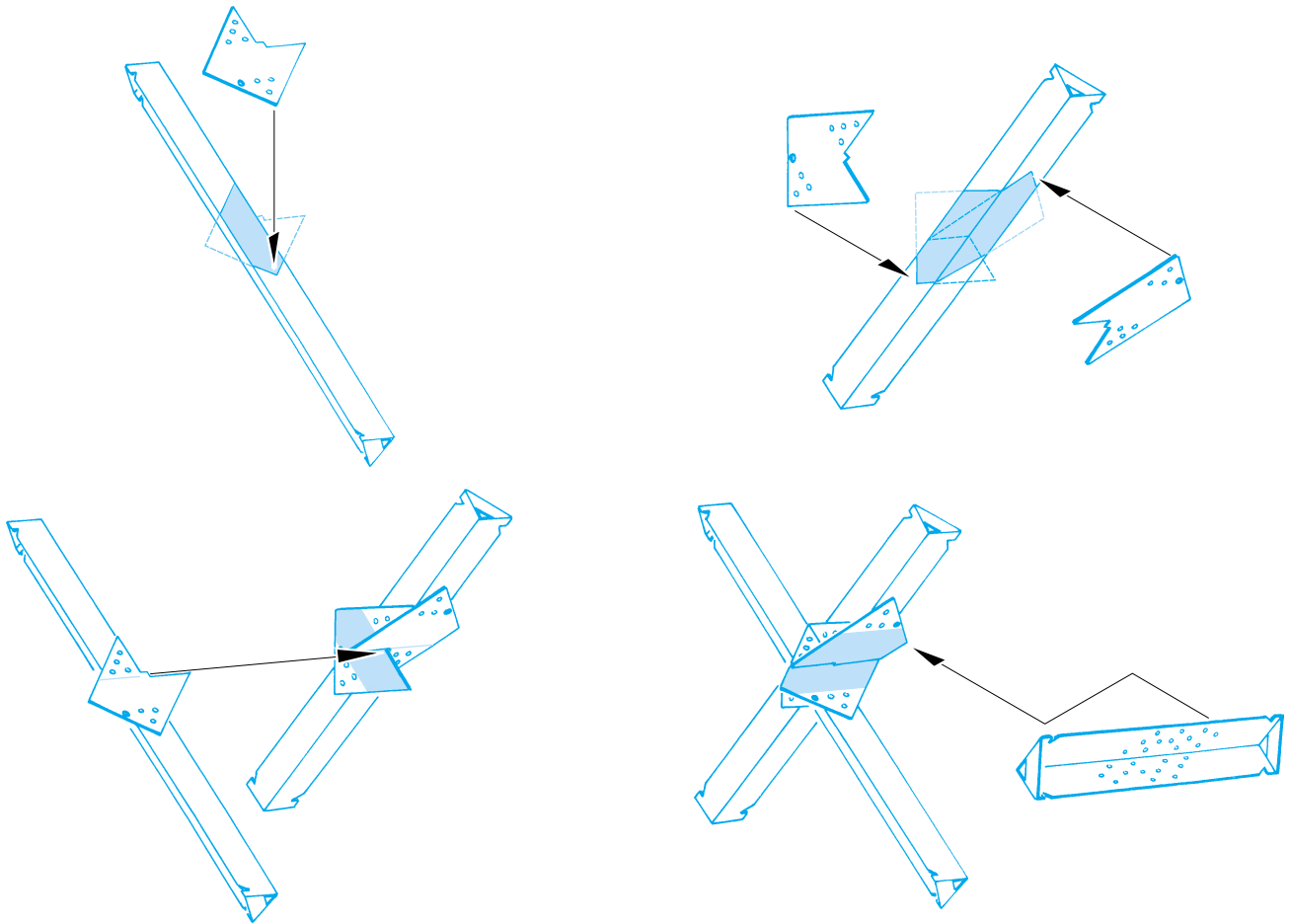

A

1.)

Plastic



2.)

Push

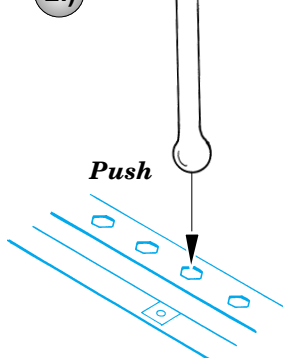

3.)

Cut

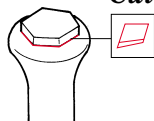

4.)

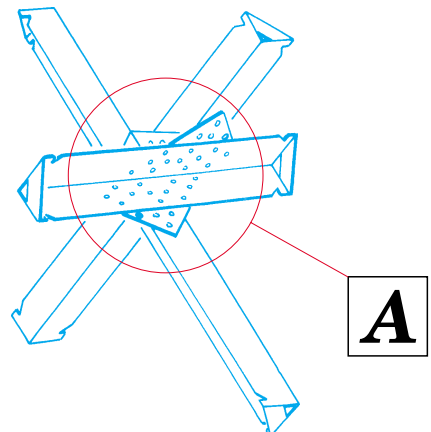

A