

**eduard**  
**Express Mask**

**XL 502**

# F4F National Insignia red outline

FOR 1/32 KIT

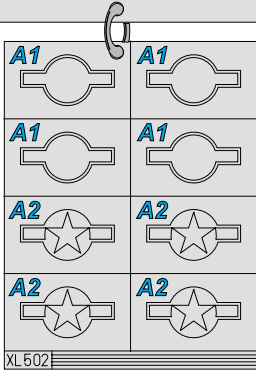

1.)

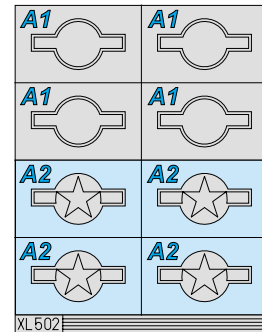
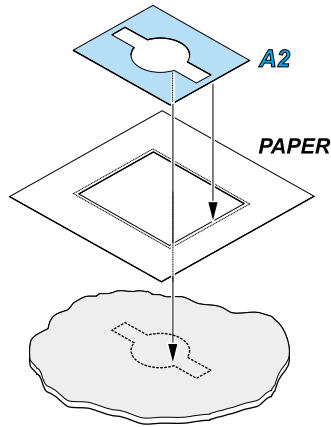

## REFERENCES:

IN DETAIL & SCALE VOL.65  
 John M. Elliott  
 THE OFFICIAL MONOGRAM  
 US NAVY & MARINE CORPS  
 AIRCRAFT COLOR GUIDE  
 (vol.2 1940-1949)

2.)

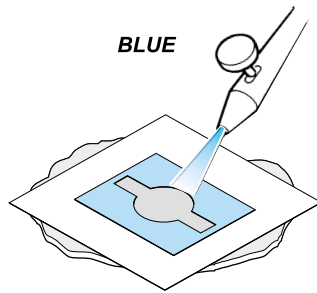

3.)

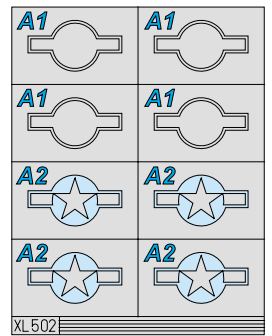
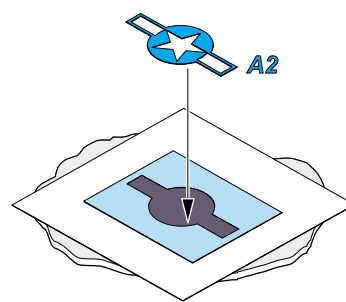

4.)

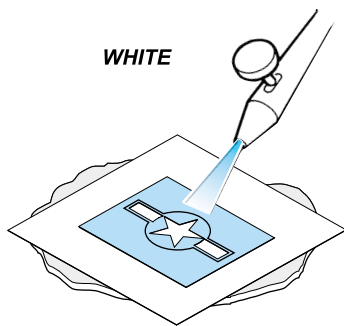

5.)

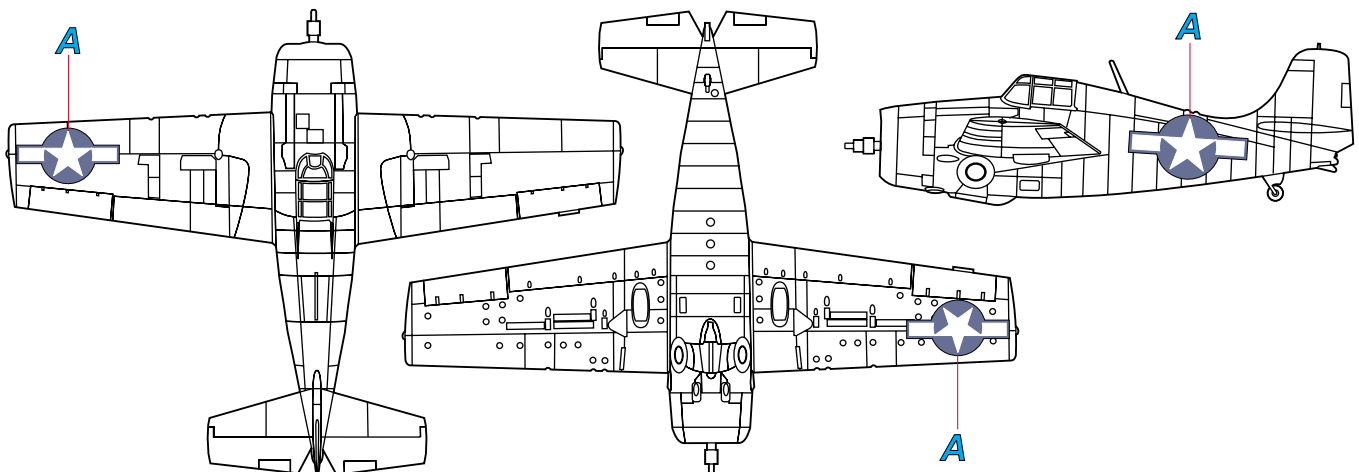
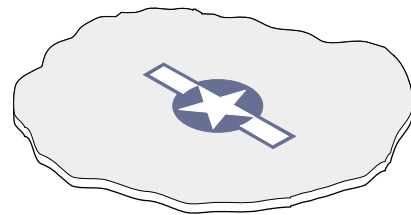

1.)

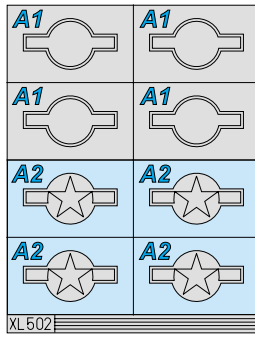
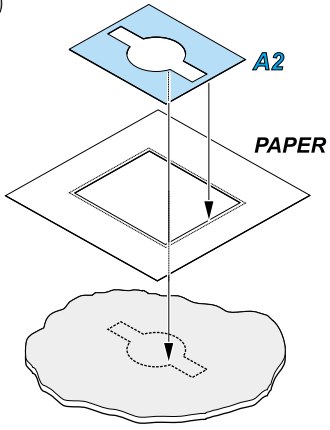

2.)

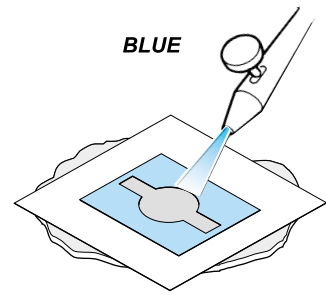

3.)

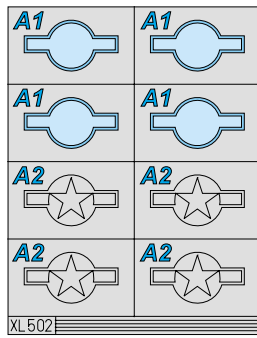
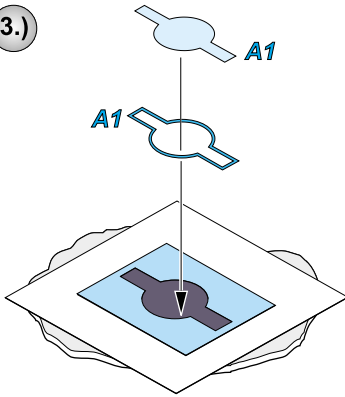

4.)

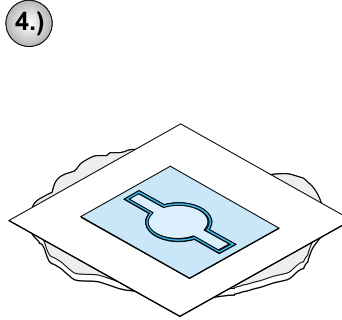

5.)

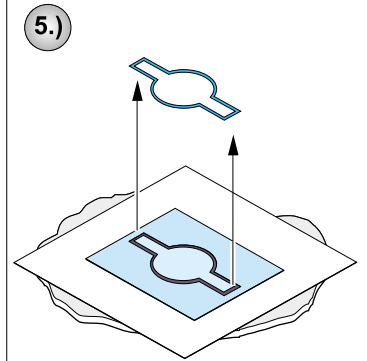

6.)

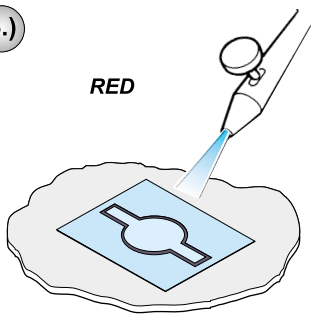

7.)

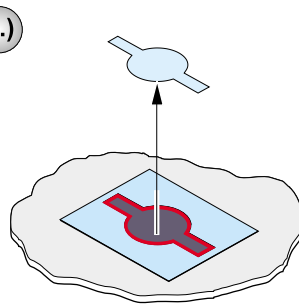

8.)

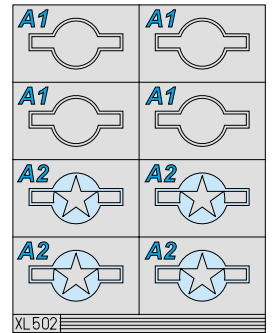
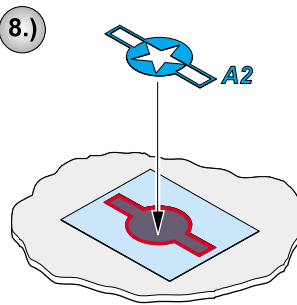

9.)

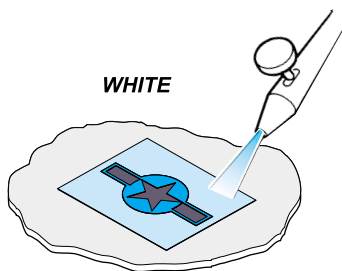

10.)

