

eduard
Express Mask

U-2

The die-cut mask for accurate canopy frame painting of the
Italeri 1/48 KIT

XF 206

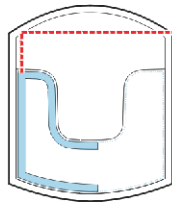
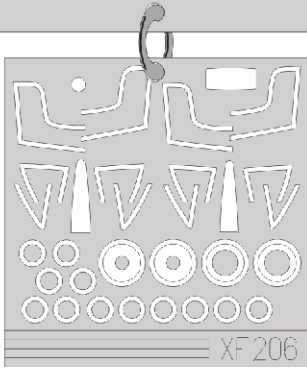

D27

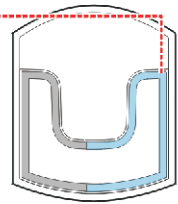
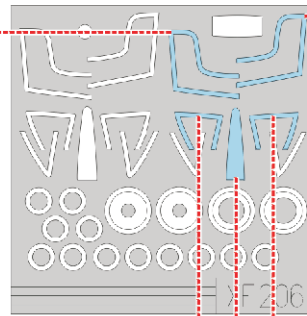

D27

1.)

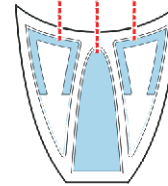

D28

LIQUID MASK

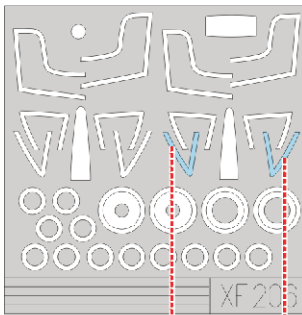

2.)

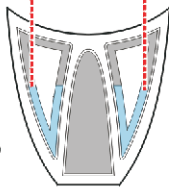

D28

3.)



INTERIOR
COLOR

4.)



RUBBER
COLOR

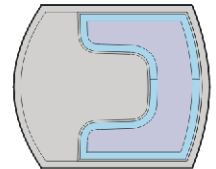
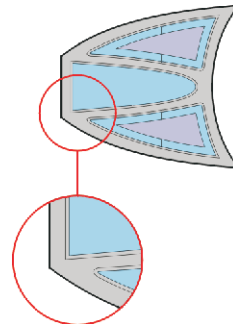

5.)

REMOVE
MASK

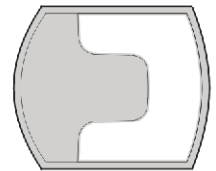
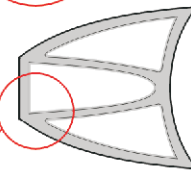
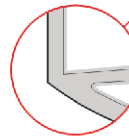

6.)

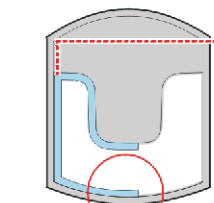

D27

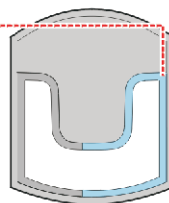
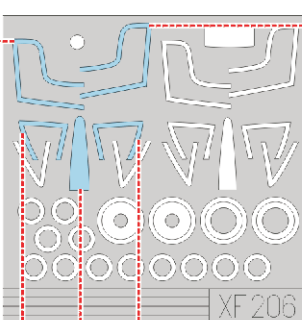

D27

7.)

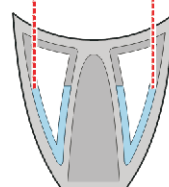
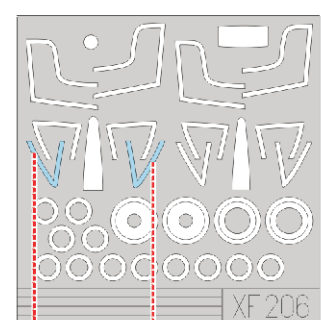

D28

8.)



CAMOUFLAGE COLOR

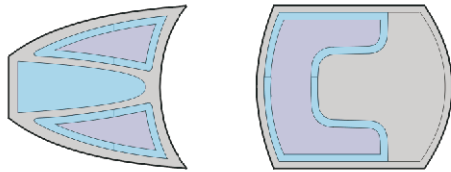

 - LIQUID MASK

9.)

REMOVE MASK

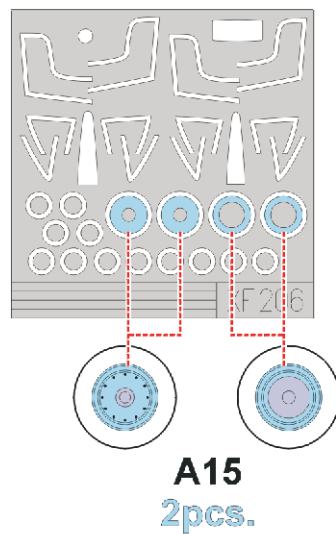
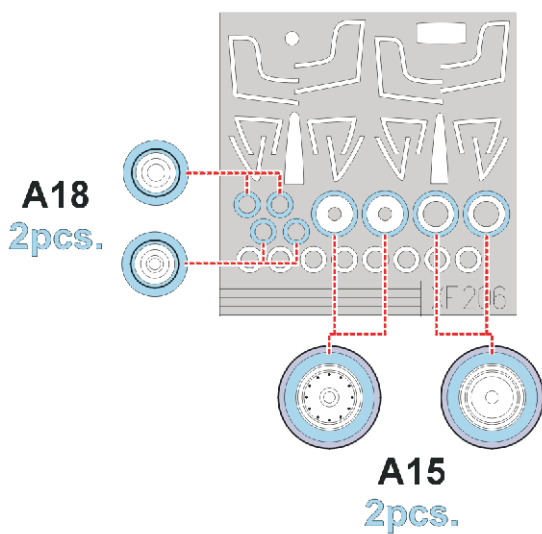
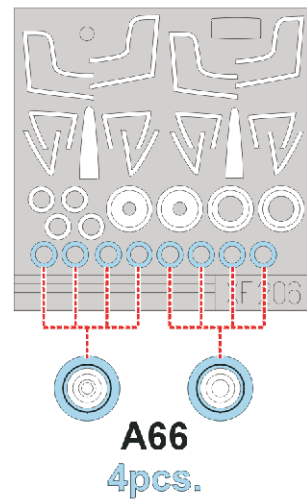
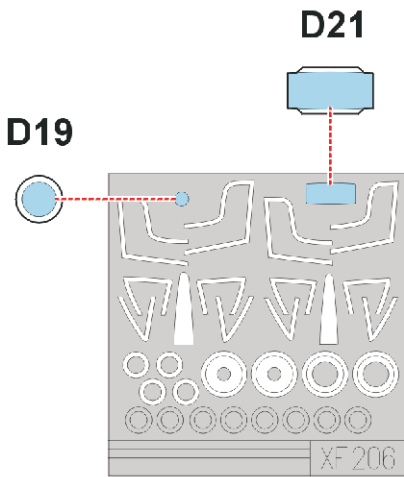
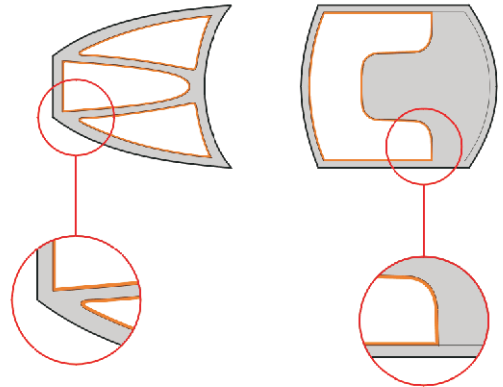

 - LIQUID MASK

REFERENCES: Sqadron/Signal Publ.: # 1086 - U-2 Spyplane