

eduard
Express Mask

XF 164

S-3 Viking

The die-cut mask for accurate canopy frame painting of the
AMT 1/48 KIT

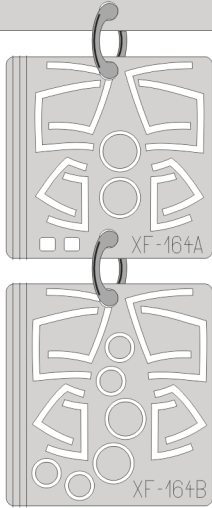

2pcs.

81

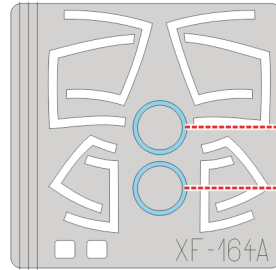
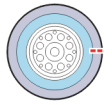

XF-164A

2pcs.

85

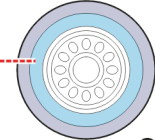

81

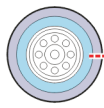

2pcs.

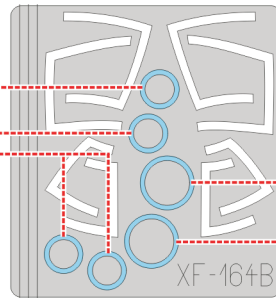

XF-164B

86

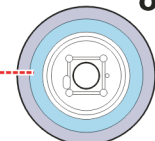

2pcs.

■ - LIQUID MASK

1.) 104

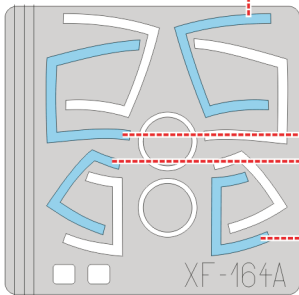
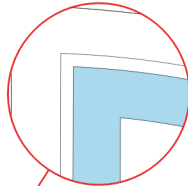

XF-164A

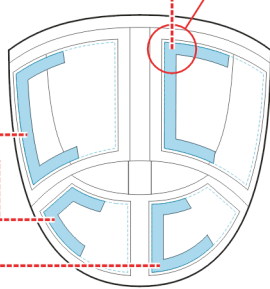

2.) 104

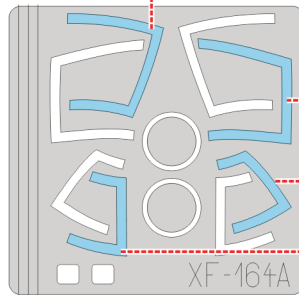

XF-164A

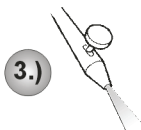
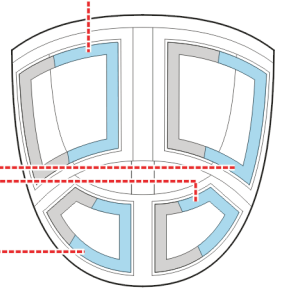

3.) **INTERIOR COLOR**

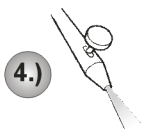

4.) **RUBBER COLOR**

■ - LIQUID MASK

104

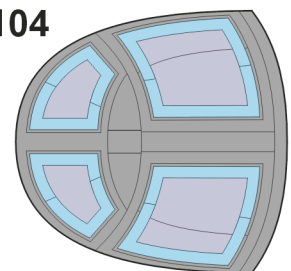

5.) REMOVE MASK

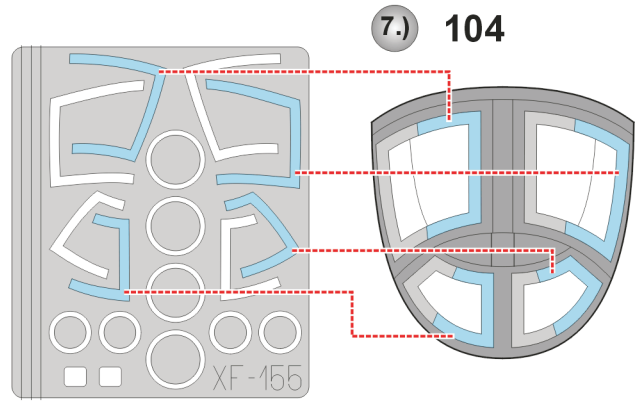
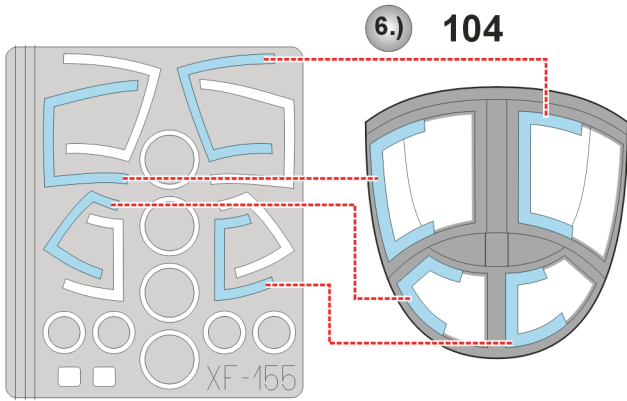
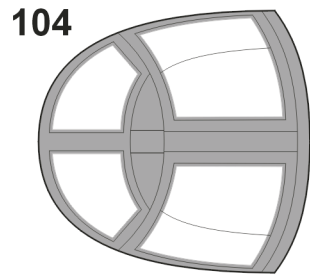

8.) CAMOUFLAGE COLOR

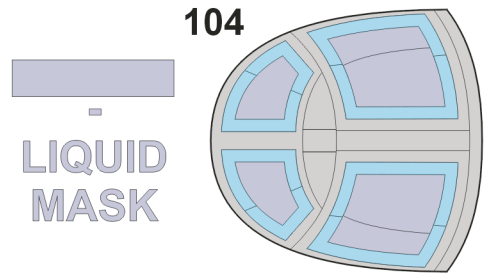

9.) REMOVE MASK

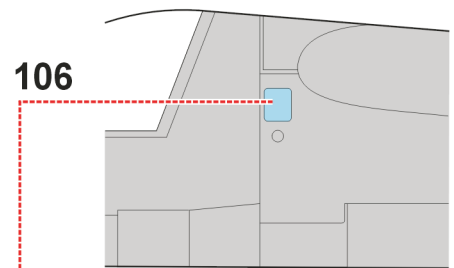
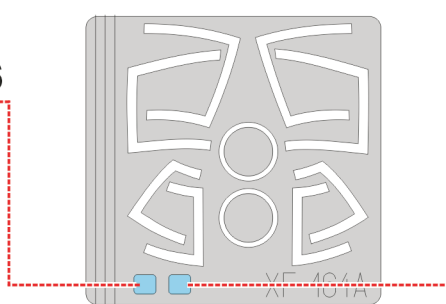
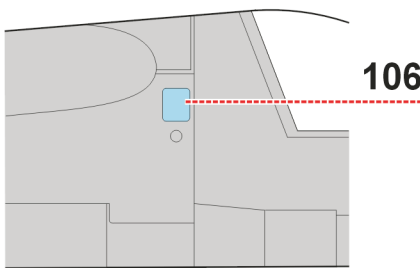
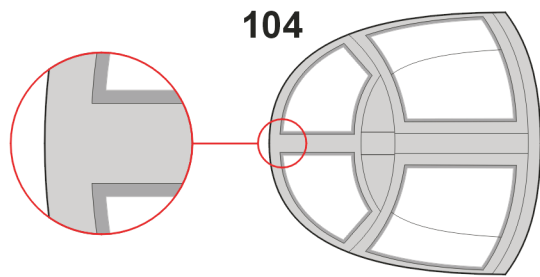

REFERENCES: Concord Publ. #1019 - U.S. AIRPOWER AT SEA
Replic #50/octobre 1995