

**eduard**  
**Express Mask**

**XF 118**

# B-24J Liberator

The die-cut mask for accurate canopy frame painting of the  
*Monogram 1/48 KIT*

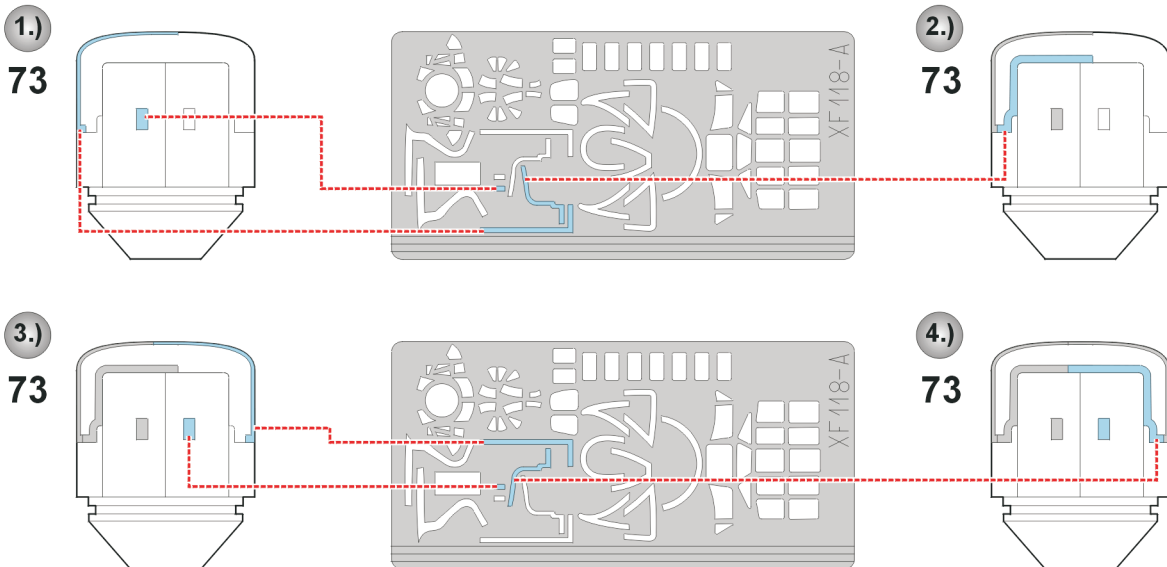
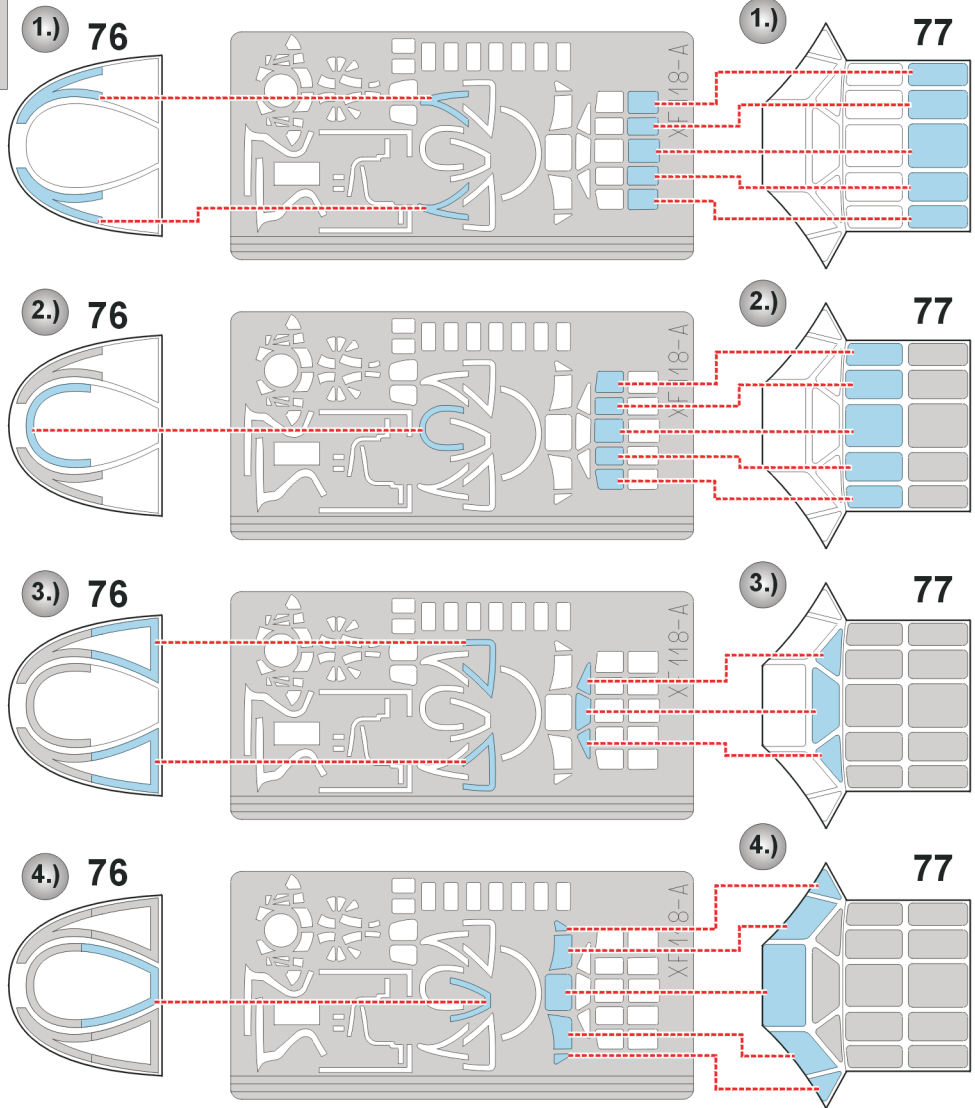
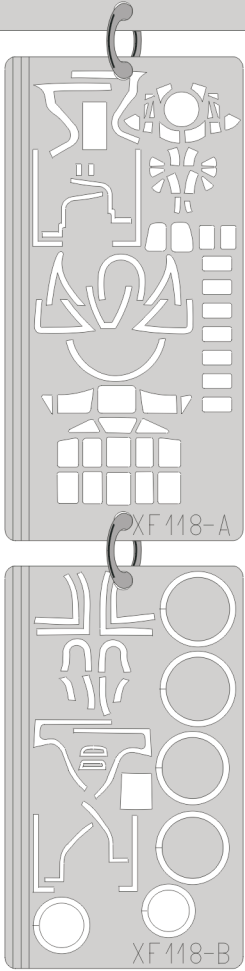

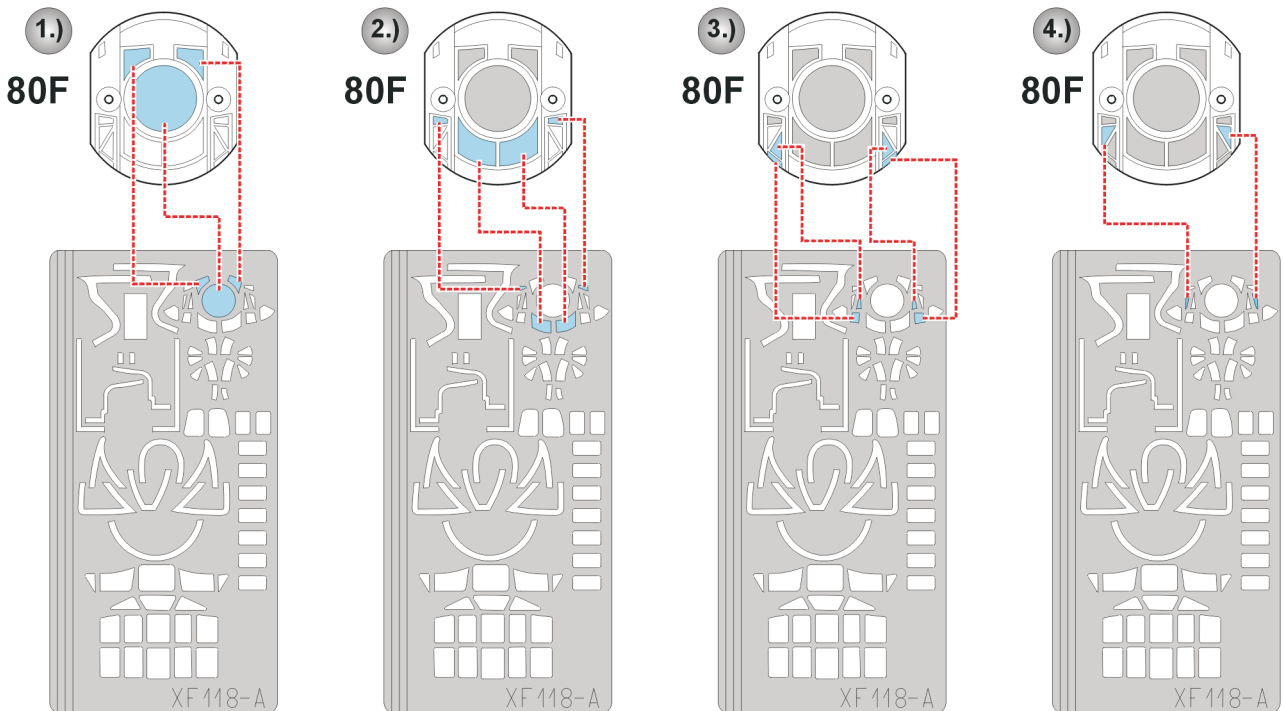
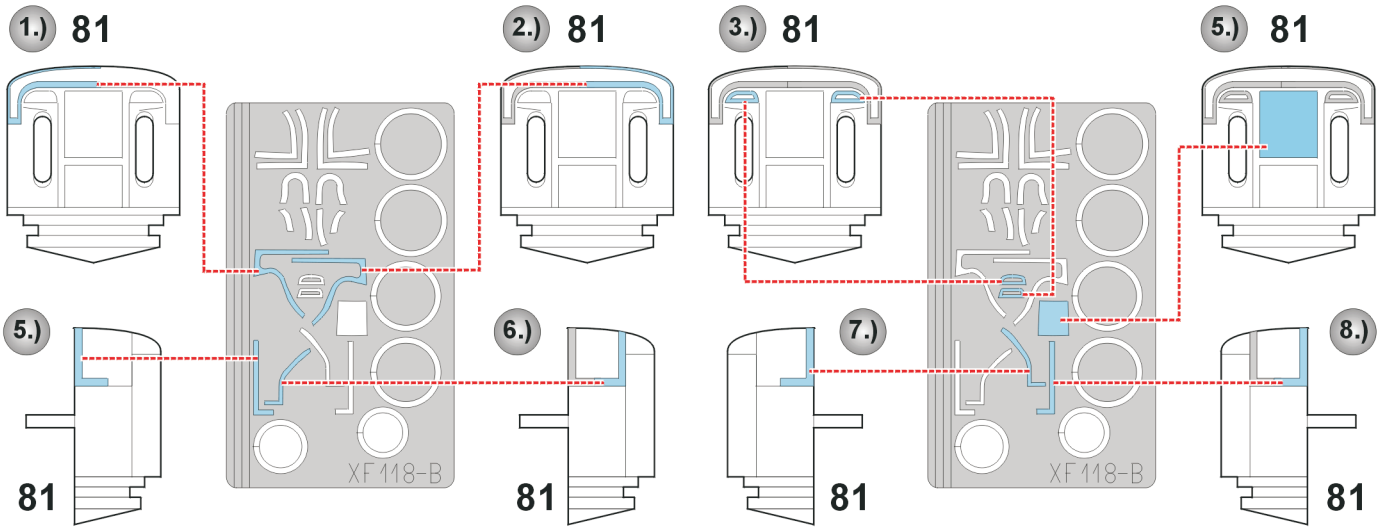
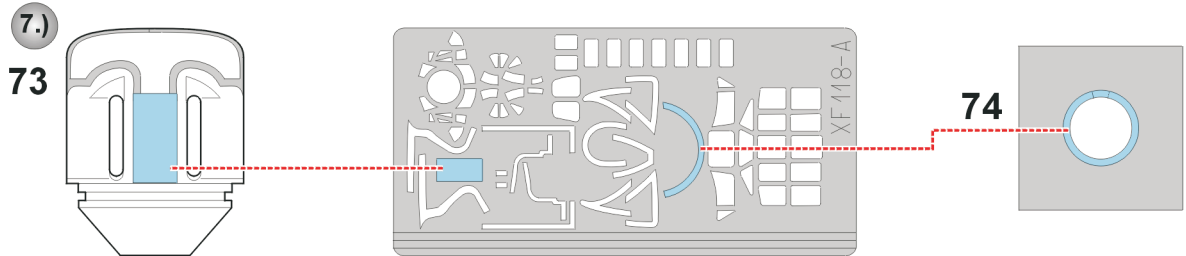
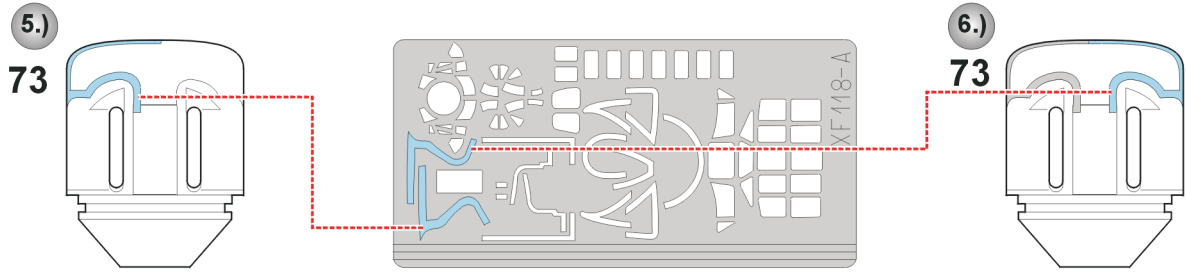

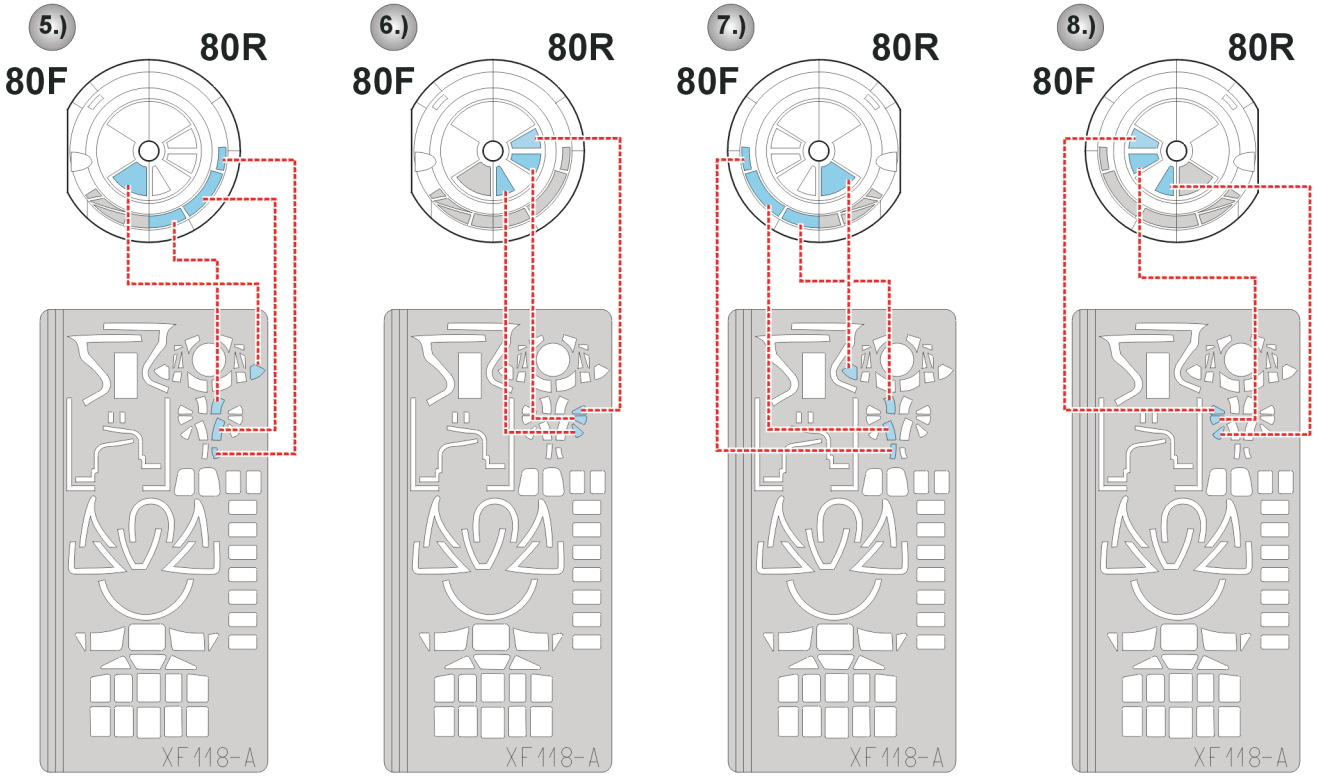

### INTERIOR COLOR

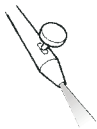

LIQUID MASK

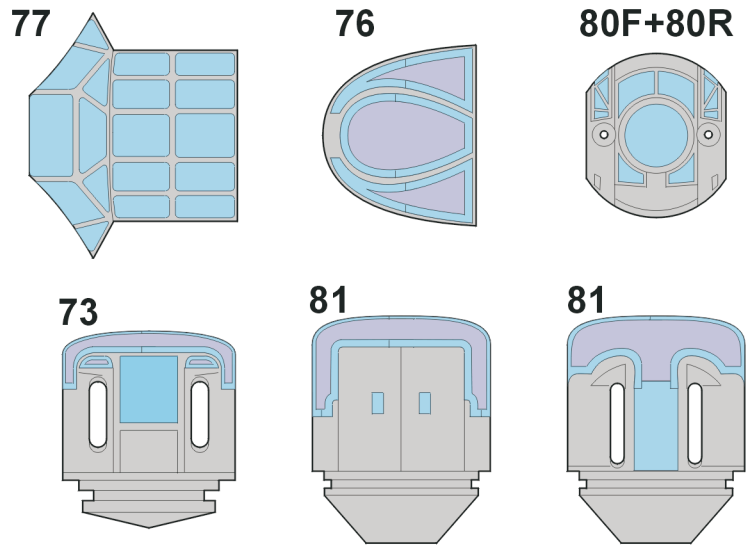

### CAMOUFLAGE COLOR

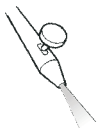

74

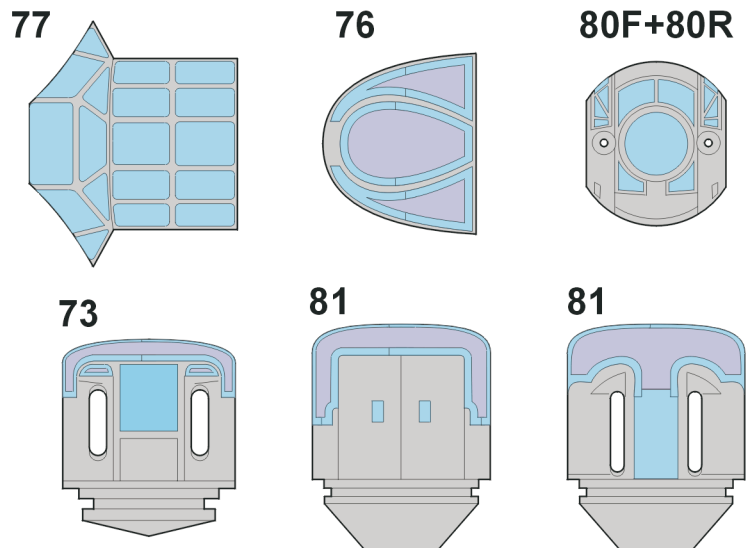
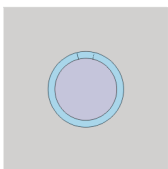

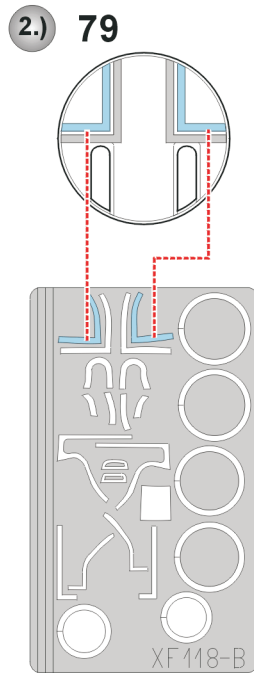
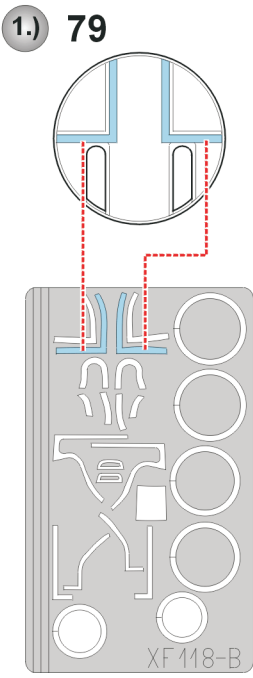

3.) INTERIOR COLOR

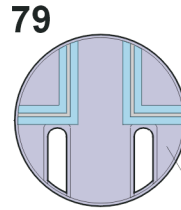

4.) CAMOUFLAGE COLOR

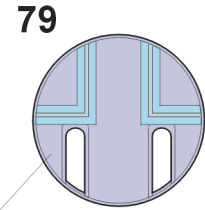

LIQUID MASK

5.) REMOVE MASK

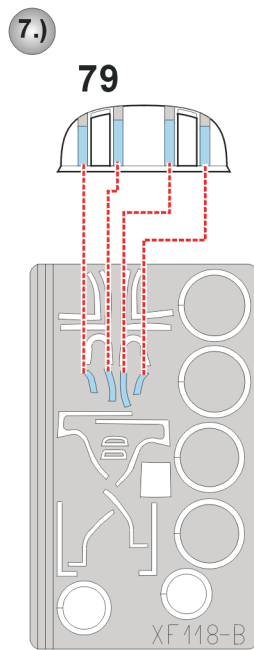
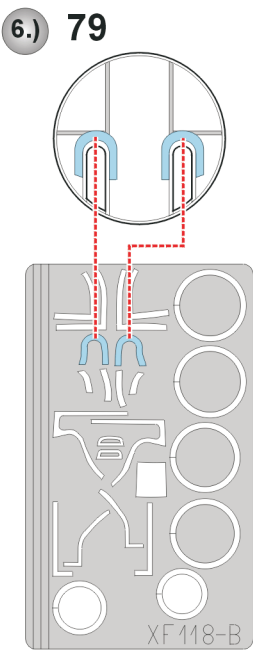
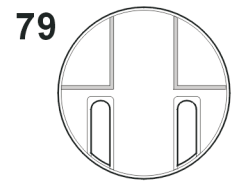

8.) INTERIOR COLOR

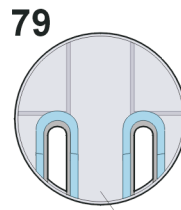

9.) CAMOUFLAGE COLOR

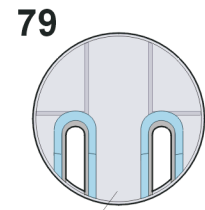
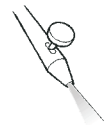

LIQUID MASK

10.) REMOVE MASK

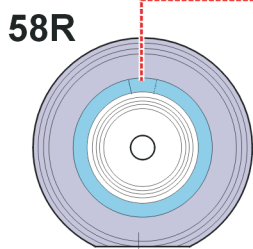
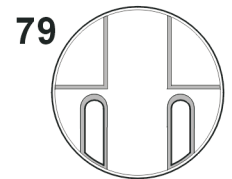

LIQUID MASK

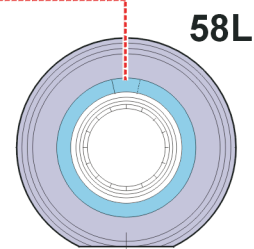
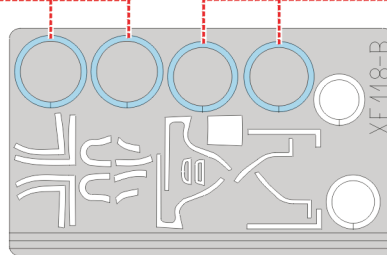

LIQUID MASK

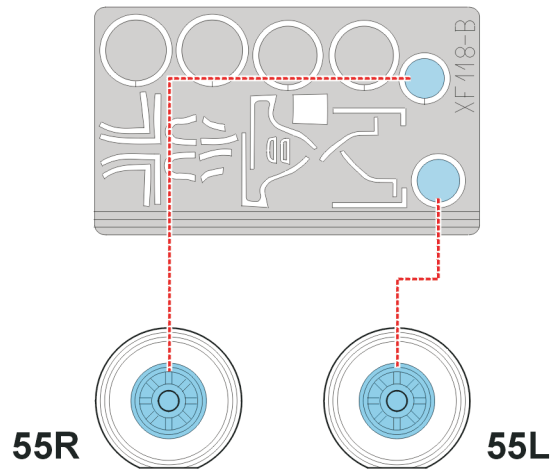
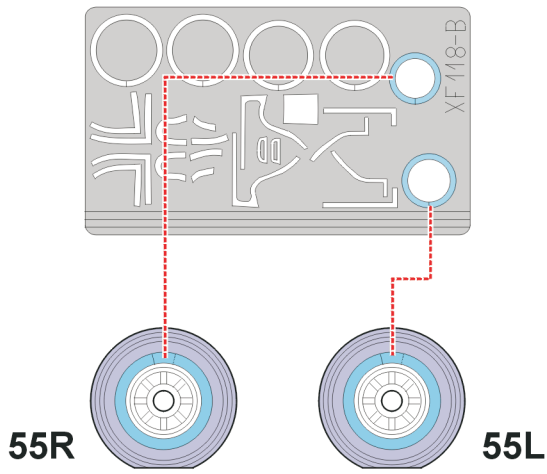

### LIQUID MASK

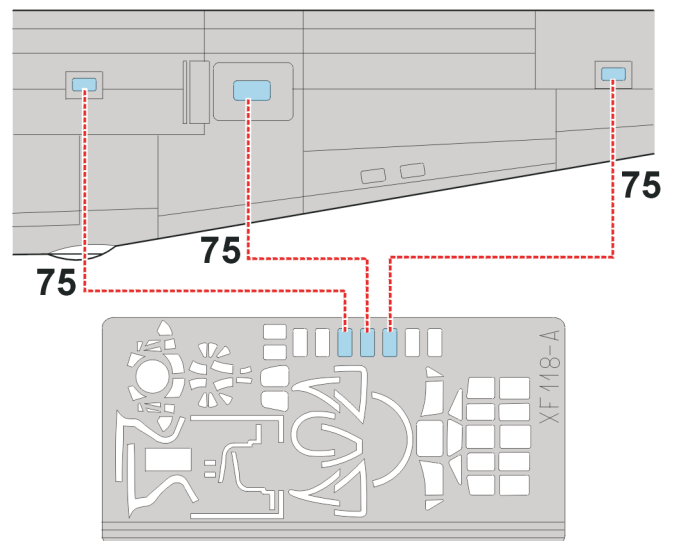
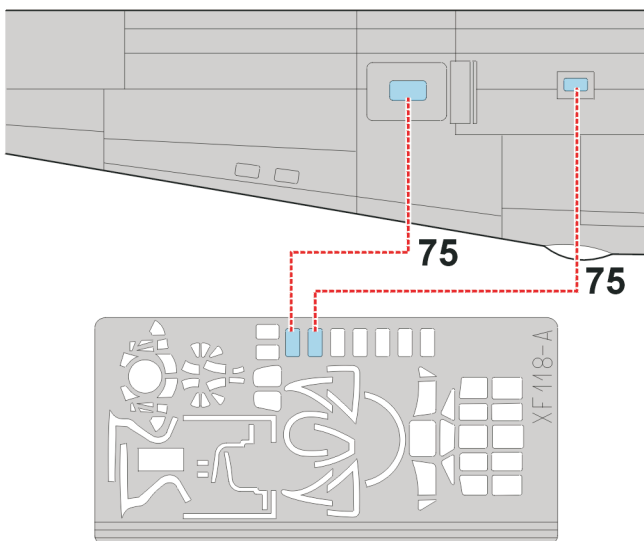
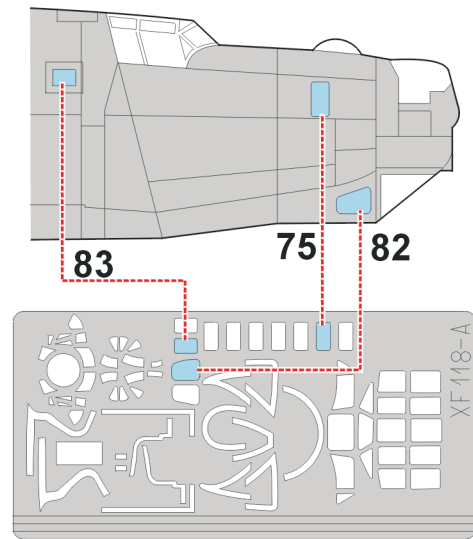
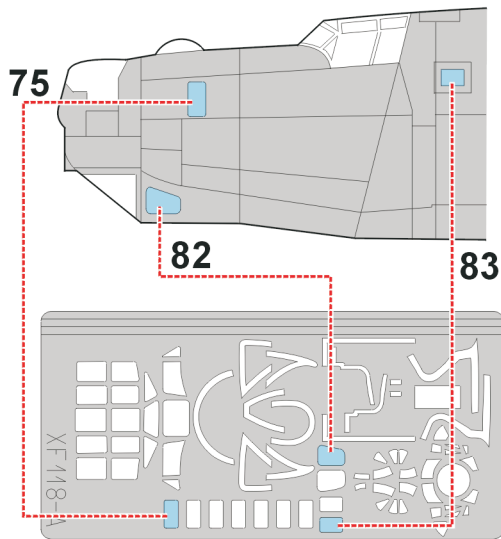

**REFERENCES:** Sqadron/Signal Publ.:In Detail # 8264 - B 24 Liberator  
Special MACH 1 - B-24 Liberator