



INFORMATION FOR DISTRIBUTORS

APRIL 2016

Dear Friends,

The Nuremberg Toy Fair concluded two weeks ago, and as usual, it gave us a glimpse into what awaits us in the next few months. Even though there was the typical gloom and doom talk about the lack of new items, and that the industry is in a downturn, my personal view is that there will be a lot to do in the coming year with no shortage of new photoetched, masks and Brassins to release. With respect to new kit releases, the story is similar, and despite the same talk of not enough new releases and too many clone editions, the fact of the matter is that there are more new releases planned this year than last, and even the kit reboxings that are planned are more than just sentimental heart tuggers. I have no worries about them not able to generate much interest. On the contrary, I think there are some items that will go very quickly. We'll be able to test this out in April, with the release of this year's likely star attraction, the Profipack Bf 109G-6 Late Version in 1/48th scale. The kit, under the catalog number 82111, is being released with boxart produced by Mr. Koike Shigeo, depicting an aircraft flown by Hauptman Friedrich Eberle, CO of III./JG 1. There is a total of five marking options available in this kit. These are a mix of striking and colorful markings, some of which are not generally that well known. All in all, they are aircraft with the lighter canopy variant commonly known as Erlahaube (properly called Volsichtshaube). A part of the offered versions have the classic low rudder, and some the newer taller one. The decals are printed by Eduard, a decision we made for their ease of application and overall quality that we think is not too far off of those printed by Cartograf. The marking options offered and the boxart will no doubt be attractive to modelers, but the plastic is what will set this kit apart. A lot of modelers are anxiously awaiting the results of the revision of the original kit, and the depth of the changes are still largely unknown to most. I am sure that they will all be very welcome. Any assumptions that we shortened the model and left the details alone are erroneous. Compared to the Gustav released two years ago, we are talking a whole new animal, here, with a new and innovative design and with completely new tools. It will be possible to find components that are identical, since most of the small detail parts needed no intervention, but, on the other hand, a long list items were improved upon. We increased the number of alternative parts to accommodate various subtypes which the initial kit didn't take into account. As an example, the aforementioned tall fin is offered in both metal and wooden incarnations with three types of rudders, from which it is possible to easily account for a further two subtypes. The situation is similar with respect to the canopies, and for the current kit, the Volsichtshaube comes in three versions. The biggest changes come with the biggest components, these being the fuselage and wings whose excessive dimensions were the main reason for revising the kit. Besides the overall decrease in the size of the model, we also embarked on a rather complicated improvement on the shape of the fuselage. This concerns small modifications to the tune of tenths of millimetres that at first glance would be very difficult to ascertain, but we feel they will add much to the overall look of the finished product. The wing carries with it one of the main conceptual changes in the kit. The wing tips were separate pieces in the original kit, while here they are moulded integrally with the top wing half. This should aid in ease of assembly of the kit. Also new in this kit are the photoetched brass accessories and masks. Also new for this kit will be other accessory items released for it. Together with the kit release, we are also coming out with five Brassin sets in April, one photoetched set, two alternate seatbelt sets and four mask sets, a set of masks for the spinner spirals and three basic camouflage schemes for individual factories. Releasing kits together with their accessories has become our norm, as you are well aware. This methodology has proven itself recently, and the entire collection of lines work together as a production system, which offers a certain marketing potential. I am confident that it will prove itself in this case as well, and that this time, there will not be a repeat of the lukewarm reception that we saw two years ago.

It is, however, very possible that questions will be asked concerning the possible exchange of the old kit for the new one, whether for the entire kit or certain components. We will not be offering any such exchange. Kit No.82111 Bf 109G-6 Late Version in no way corrects or replaces anything in the original kit, No. 8268 Bf 109G-6. The same will apply to accessory kits. The Bf 109G-6 is not the only interesting item being prepared for release in April. There are two Weekend kits, the nightfighting F6F-5N in 1/72 and a 1/48 Fokker D.VII (OAW). This one deviates a bit from the norm of this line in the way of having two decal sheets covering the lozenge pattern of the fabric surfaces. The two marking options for this model are new and not offered til now. Finally, we have one upgrade edition that deserves a more detailed commentary. Last year, we released a Limited Edition F-104G in 1/48 under the name of Bundesfighter, that sold out extremely quickly. To the contrary, the F-104G NATOfighter still has some 1000 pieces left in our warehouse. We have decided to convert and upgrade the remaining kits with decals and instructions from Bundesfighter under the new heading Bundesfighter/NATOfighter with the catalogue number 1133.

I think that from a successful marketing point of view for April, the Gustav would suffice quite nicely on its own. But, along with the other projects in the works, most notably the upgraded Bundesfighter and the Weekend Fokker D.VII, which, as most of you will know have little in common historically with the Bf 109, the month promises to be quite lively. Don't hesitate, especially with respect to the Bundesfighter, because its numbers are very limited and final. The models are not alone, and the accessory assortment is very wide, as is the usual case, and deserves attention. The Brassins are also not limited to the Bf 109G. For instance, the 1/72 scale UB-16 and UB-32 pods are a response to customer demand, same going for two sets for the F-4J which were originally reserved for the Rockin Rhino Limited Edition release.

The Chinese year of the monkey has begun. Traditionally, this is an unlucky, chaotic and confusing year. Well, we are not Chinese, so hopefully this will all miss us. I wish you all success with our products!

Vladimír Sulc

Product previews are subject of change.
Instruction sheets,
more pictures and information
can be found on www.eduard.com
You can download this leaflet on www.eduard.com

eduard

PLASTIC KITS



7434 **F6F-5N Nightfighter**
1/72 Weekend

[DETAIL](#)



82111 **Bf 109G-6 late series**
1/48 ProfiPACK

[DETAIL](#)

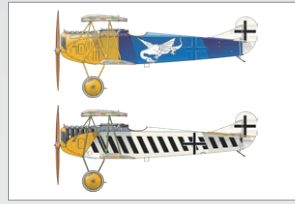

84155 **Fokker D.VII OAW**
1/48 Weekend

[DETAIL](#)



1133 **BUNDES/NATOfighter**
1/48 Limited edition

[DETAIL](#)

MASKS

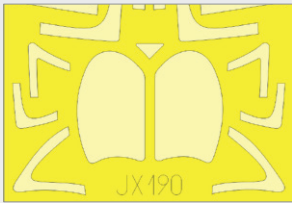

JX190 **A-6E TRAM**
1/32 Trumpeter

[DETAIL](#)

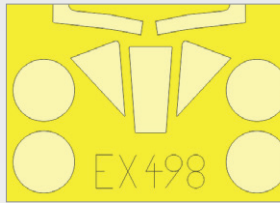

EX498 **Meteor F.8**
1/48 Airfix

[DETAIL](#)

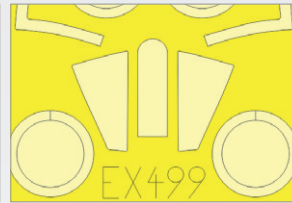

EX499 **J-29 Tunnan**
1/48 Hobby Boss

[DETAIL](#)

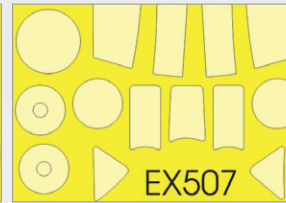

EX507 **Me 262B-1a/U1**
1/48 Hobby Boss

[DETAIL](#)

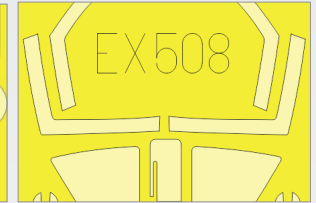

EX508 **Sea Harrier FRS.1**
1/48 Kinetic

[DETAIL](#)

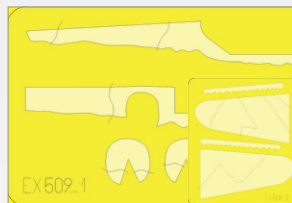

EX509 **Bf 109G camo scheme - Mtt** 1/48 Eduard

[DETAIL](#)



EX510 **Bf 109G camo scheme - Erla** 1/48 Eduard

[DETAIL](#)



EX511 **Bf 109G camo scheme - WNF** 1/48 Eduard

[DETAIL](#)



EX512 **Bf 109G spinner spirals** 1/48 Eduard

[DETAIL](#)



EX513 **Fokker D.VII OAW Weekend** 1/48 Eduard

[DETAIL](#)

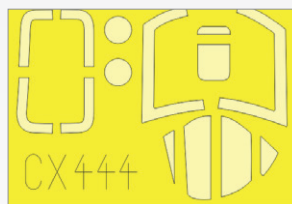

CX444 **Sea Vixen FAW.2**
1/72 Cyber Hobby

[DETAIL](#)

BIG-ED SETS



BIG5335 **Z-32 destroyer**
1/350 Dragon

[DETAIL](#)



BIG3360 **A.S. 51 Horsa Glider Mk.I** 1/35 BroncoModels

[DETAIL](#)



BIG3361 **P-39Q/N Part. I**
1/32 KittyHawk

[DETAIL](#)



BIG49146 **Pe-2**
1/48 Zvezda

[DETAIL](#)



BIG72108 **MiG-29A Izdeliye 9-12** 1/72 Trumpeter

[DETAIL](#)

PHOTO-ETCHED SETS

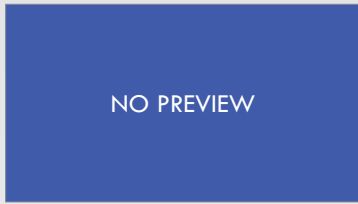

32387 A-6E TRAM exterior
1/32 Trumpeter
(1 part)

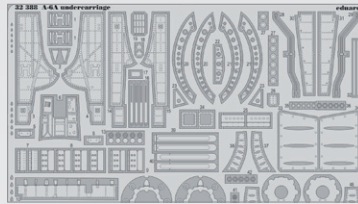

32388 A-6E TRAM undercarriage
1/32 Trumpeter
(1 part)

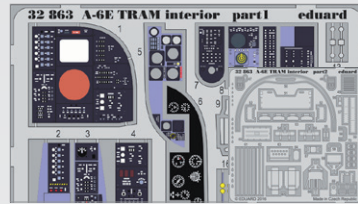

32863 A-6E TRAM interior
1/32 Trumpeter
(2 parts)

DETAIL

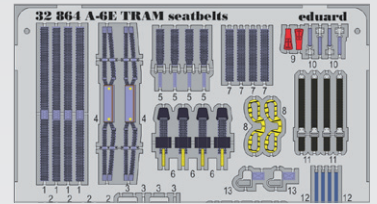

32864 A-6E TRAM seatbelts
1/32 Trumpeter
(1 part)

DETAIL

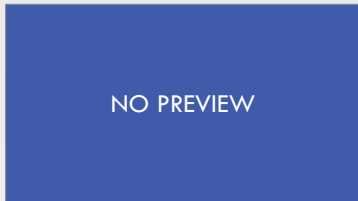

48882 Meteor F.8 undercarriage
1/48 Airfix
(1 part)

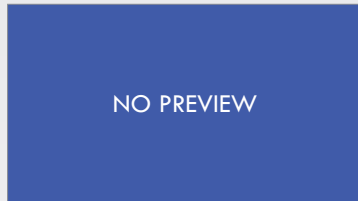

48883 Meteor F.8 engines
1/48 Airfix
(1 part)

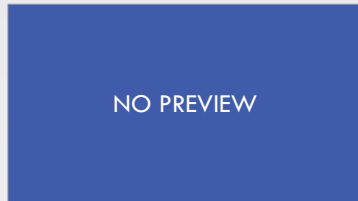

48884 Meteor F.8 landing flaps
1/48 Airfix
(1 part)

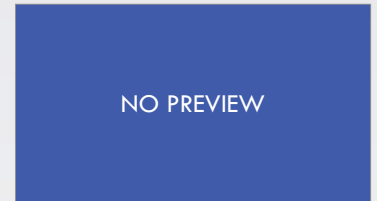

48885 Bf 109G-6
1/48 Eduard
(1 part)

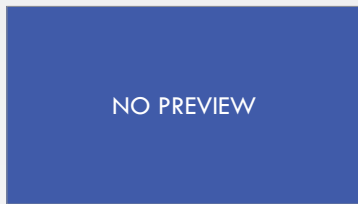

48886 Su-7 exterior
1/48 Směr
(1 part)

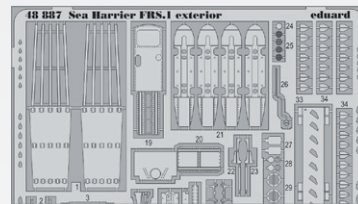

48887 Sea Harrier FRS.1 exterior
1/48 Kinetic
(1 part)

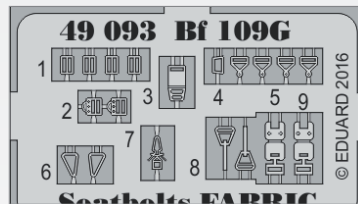

49093 Bf 109G seatbelts FABRIC
1/48 Eduard
(1 part)

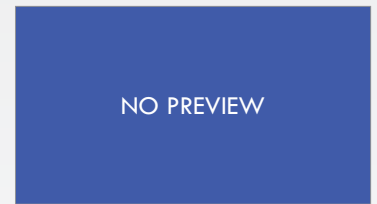

49094 Bf 109G seatbelts
SUPERFABRIC 1/48 Eduard
(1 part)

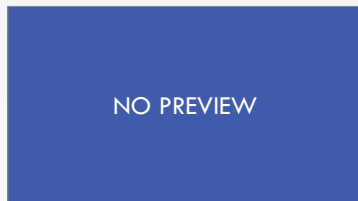

49765 Meteor F.8 interior
1/48 Airfix
(2 parts)

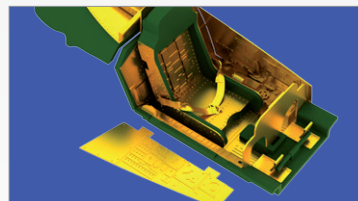

49766 J-29F Tunnan
1/48 Hobby Boss
(2 parts)

DETAIL

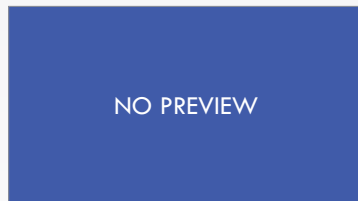

49767 Su-7 interior
1/48 Směr
(2 parts)

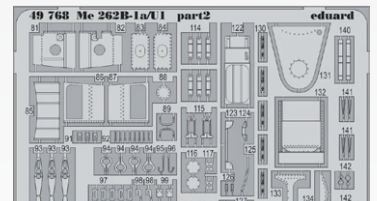

49768 Me 262B-1a/U1
1/48 Hobby Boss
(2 parts)

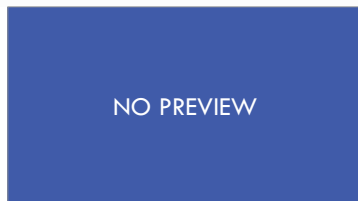

49769 Sea Harrier FRS.1 interior
1/48 Kinetic
(2 parts)

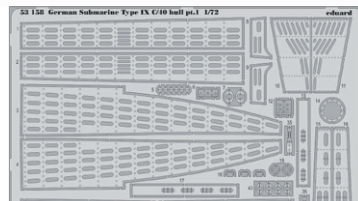

53158 German Submarine Type IX
C/40 hull pt. 1 1/72 Revell
(1 part)

DETAIL

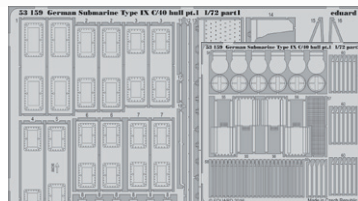

53159 German Submarine Type IX
C/40 hull pt. 2 1/72 Revell
(2 parts)

DETAIL

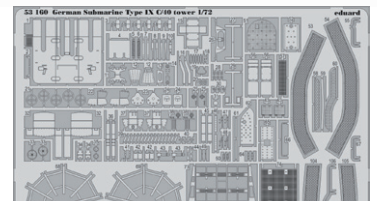

53160 German Submarine Type IX
C/40 tower 1/72 Revell
(1 part)

DETAIL

PHOTO-ETCHED SETS

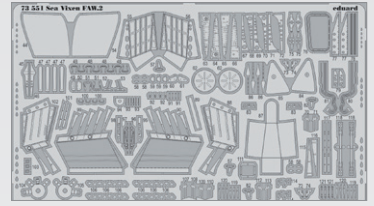
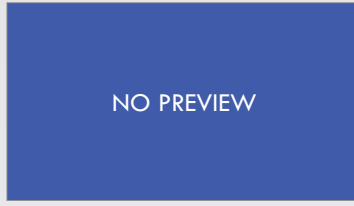
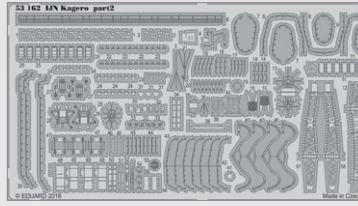
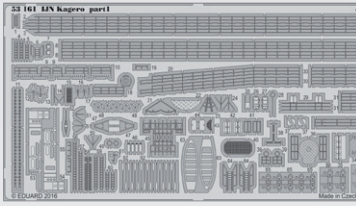

53161 IJN Kagero pt.1
1/350 Tamiya
(1 part)

53162 IJN Kagero pt.2
1/350 Tamiya
(2 parts)

73550 Hawk T.1
1/72 Revell
(2 parts)

73551 Sea Vixen FAW.2
1/72 Cyber Hobby
(2 parts)

DETAIL

DETAIL

ZOOM

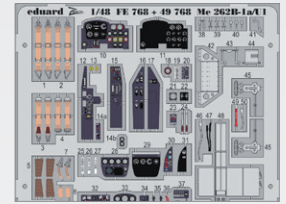
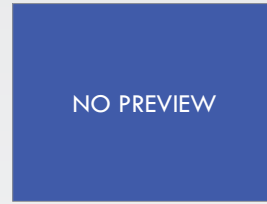
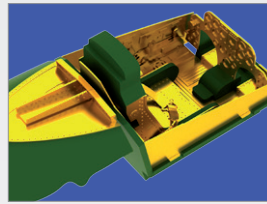
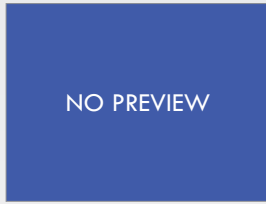
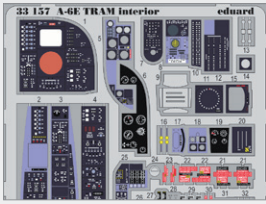

33157 A-6E TRAM interior
1/32 Trumpeter
(1 part)

FE765 Meteor F.8
1/48 Airfix
(1 part)

FE766 J-29F Tunnan
1/48 Hobby Boss
(1 part)

FE767 Su-7
1/48 Směr
(1 part)

FE768 Me 262B-1a/U1
1/48 Hobby Boss
(1 part)

DETAIL

DETAIL

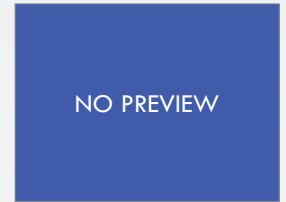
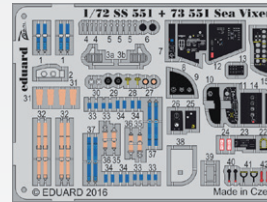
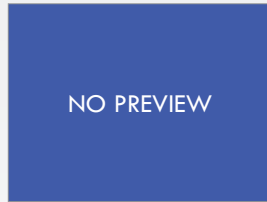
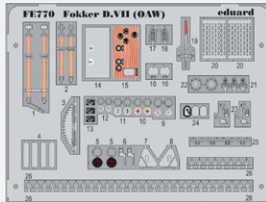
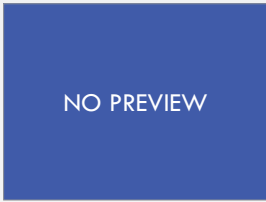

FE769 Sea Harrier FRS.1
interior 1/48 Kinetic
(1 part)

FE770 Fokker D.VII OAW
Weekend 1/48 Eduard
(1 part)

SS550 Hawk T.1
1/72 Revell
(1 part)

SS551 Sea Vixen FAW.2
1/72 Cyber Hobby
(1 part)

SS552 Fokker E.III Eindecker
1/72 Airfix
(1 part)

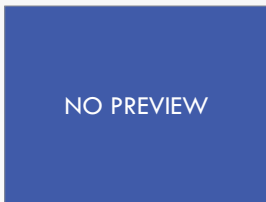
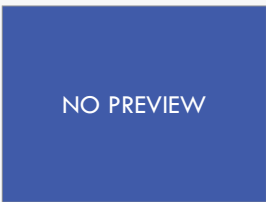

SS553 RAF BE.2c Nightfighter
1/72 Airfix
(1 part)

SS554 F6F-5N Weekend
1/72 Eduard
(1 part)

BRASSIN

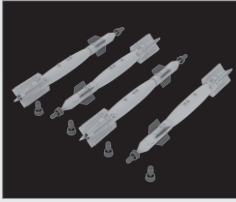

632072 GBU-12 bomb
1/32

DETAIL

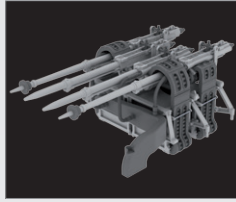

632078 Mosquito FB Mk.VI
gun bay 1/32 Tamiya

DETAIL

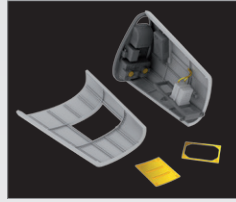

648239 Bf 109G-6 radio
compartment 1/48 Eduard

DETAIL

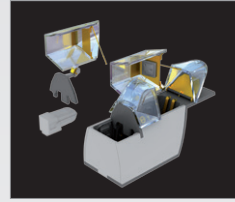

648240 Bf 109G-6 cockpit
1/48 Eduard

DETAIL

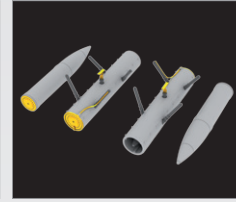

648245 W.Gr.21 for Bf 109
1/48 Eduard

DETAIL

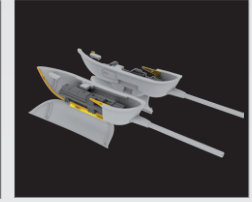

648246 Bf 109 cannon pods
1/48 Eduard

DETAIL



648247 Bf 109G exhaust
stacks 1/48 Eduard

DETAIL

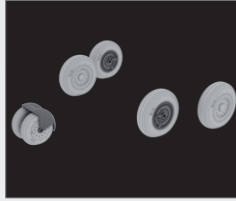

648248 MiG-31 wheels
1/48 AMK

DETAIL

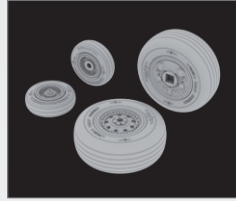

648253 F-4J wheels
1/48 Academy

DETAIL

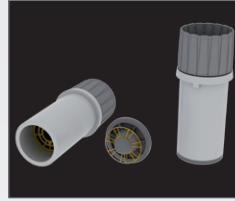

648254 F-4J exhaust nozzles
1/48 Academy

DETAIL

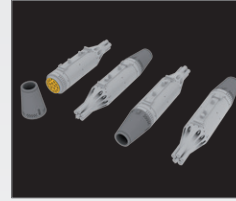

672102 UB-16 rocket pods
1/72

DETAIL

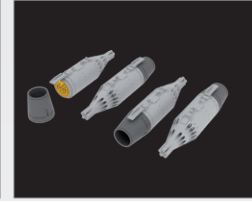

672103 UB-32 rocket pods
1/72

DETAIL

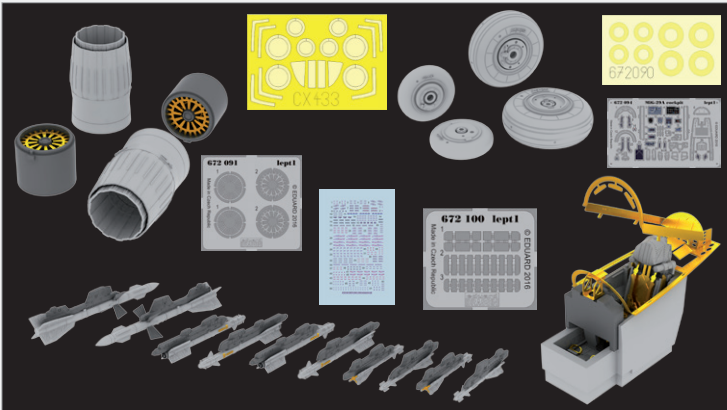

SIN67208 MiG-29A IZDELIYE 9-12
1/72 Trumpeter

DETAIL

F6F-5N Nightfighter

Scale kit of F6F-5N in 72nd scale in Weekend Edition.

BASIC INFO:

NAME: **F6F-5N Nightfighter**

CAT. NO.: 7434

SCALE: 1/72

EDITION: Weekend edition

CONTENTS:

SPRUES: Eduard

PE-SETS: No

PAINTING MASK: No

MARKINGS: 2

DECALS: Eduard

RELATED PRODUCTS:

72524 F6F-5 exterior (PE-Set)

SS554 F6F-5N Weekend (PE-Set)

72523 F6F gun bay (PE-Set)

7274 F6F-5 BiGED

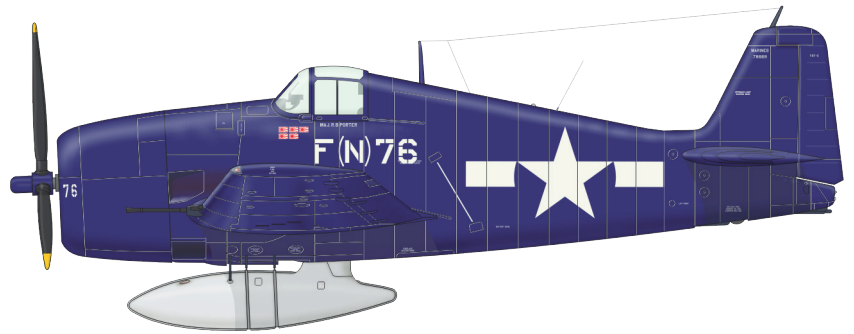
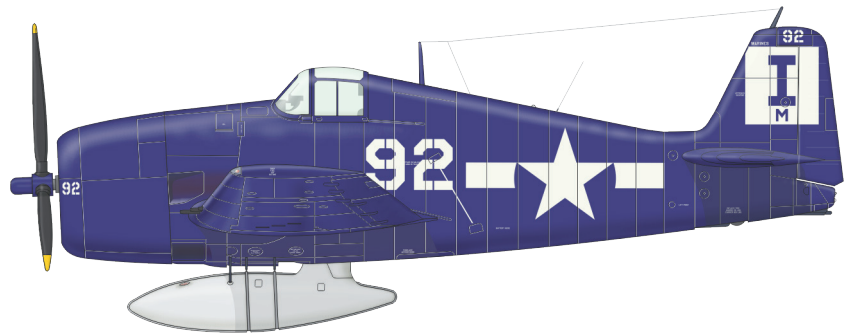

KIT PARTS

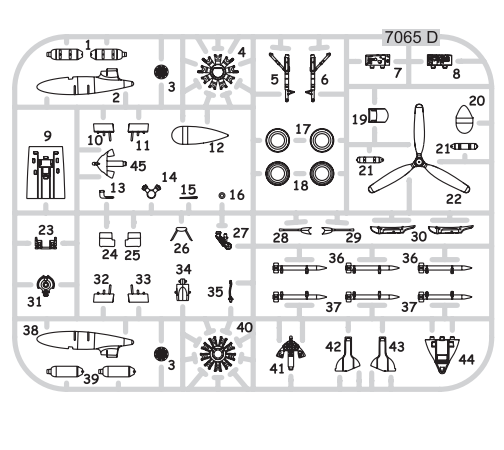
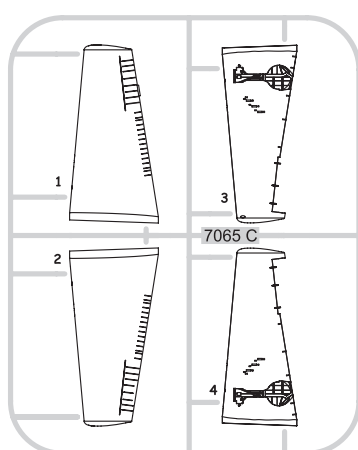
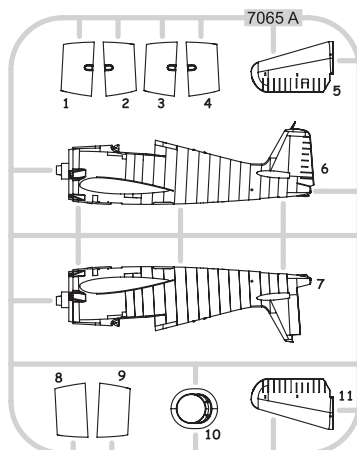
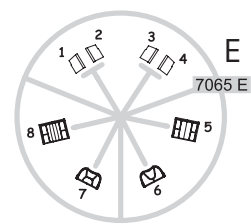
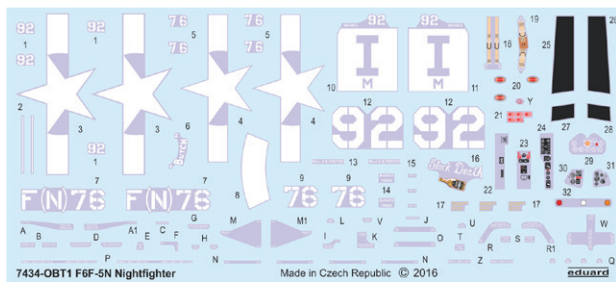

Bf 109G-6 late series

ProfiPACK
edition



Scale kit of Bf 109G-6 late series in 48th scale. New plastic parts from 2016 tool.

BASIC INFO:

NAME: **Bf 109G-6 late series**

CAT. NO.: 82111

SCALE: 1/48

EDITION: ProfiPACK

CONTENTS:

SPRUES: Eduard

PE-SETS: Yes color (No preview)

PAINTING MASK: Yes (No preview)

MARKINGS: 5

BRASSIN: No

DECALS: Eduard

RELATED PRODUCTS:

48885 Bf 109G-6 (PE-set)

49093 Bf 109G seatbelts FABRIC (PE-set)

49094 Bf 109G seatbelts SUPERFABRIC (PE-set)

648239 Bf 109G-6 radio compartment (Brassin)

648240 Bf 109G-6 cockpit (Brassin)

648245 W.Gr.21 for Bf 109 (Brassin)

648246 Bf 109 cannon pods (Brassin)

648247 Bf 109G exhaust stacks (Brassin)

EX509 Bf 109G camo scheme - Mtt (Mask)

EX510 Bf 109G camo scheme - Erla (Mask)

EX511 Bf 109G camo scheme - WNF (Mask)

EX512 Bf 109G spinner spirals (Mask)

NEW TOOL 2016

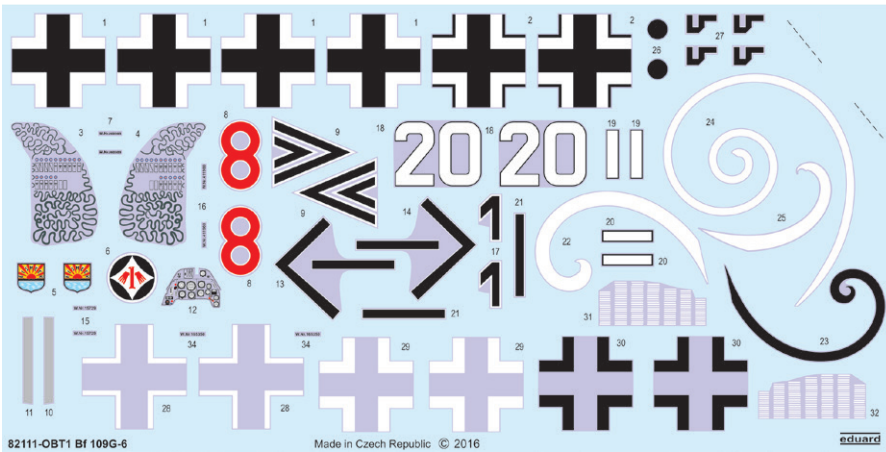

82111-OBT1 Bf 109G-6

Made in Czech Republic © 2016

eduard

KIT PARTS

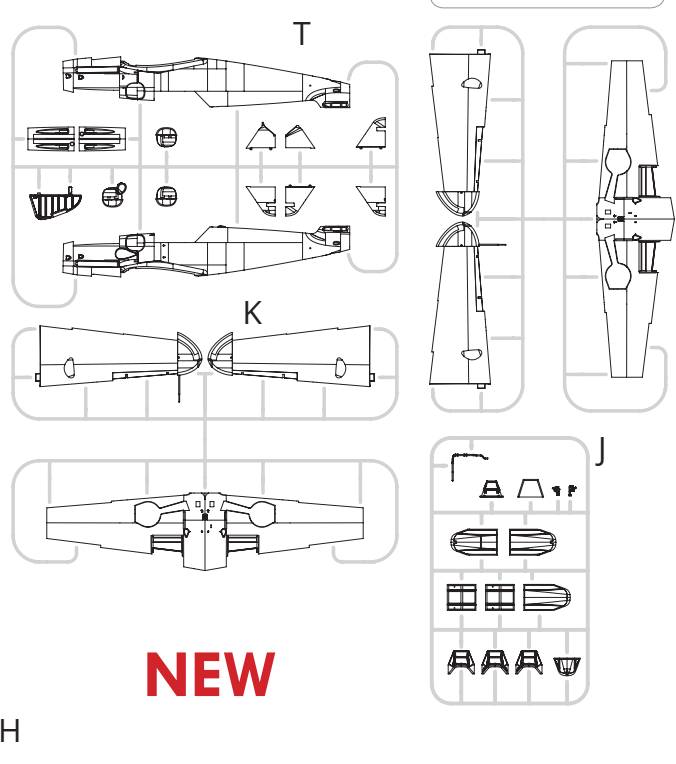
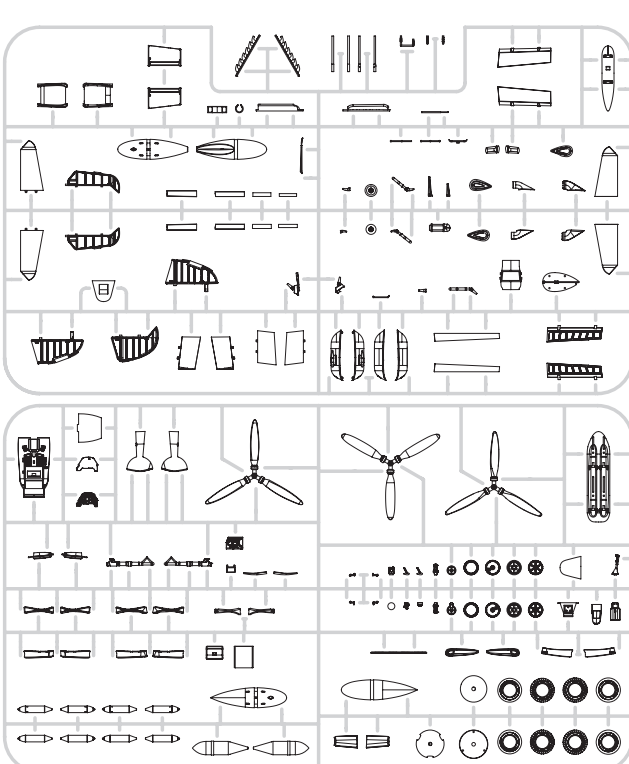

NEW

PLASTIC KITS

BACK

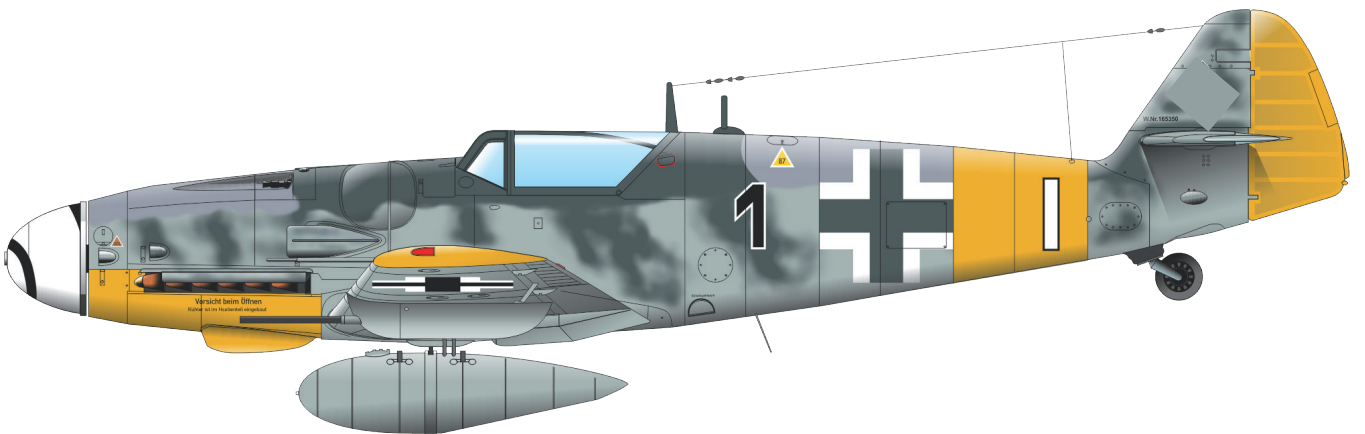
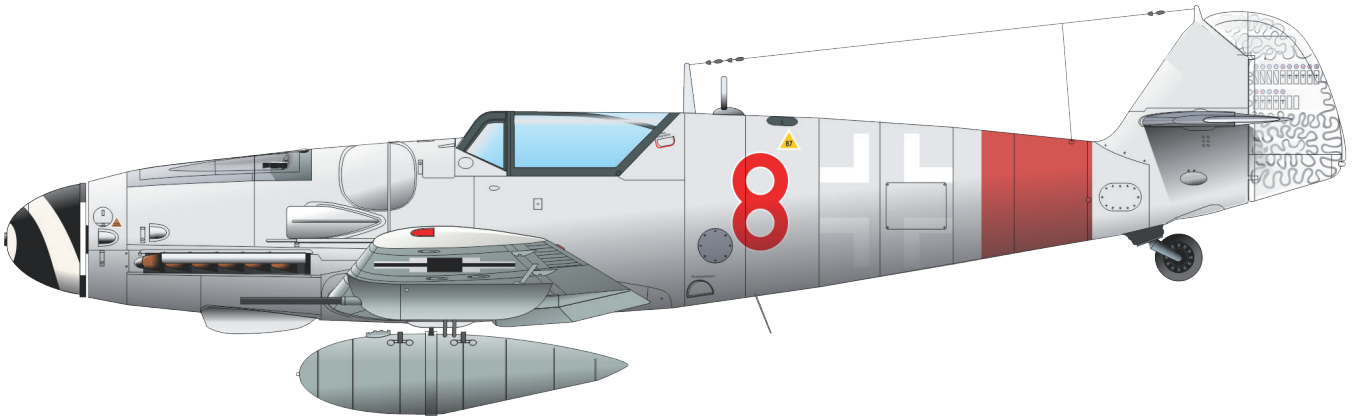
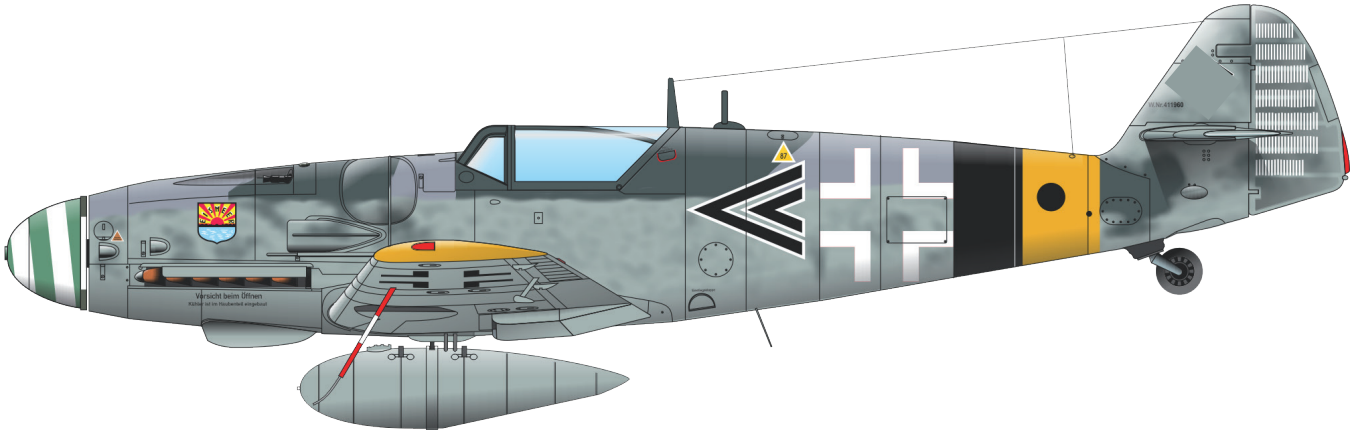
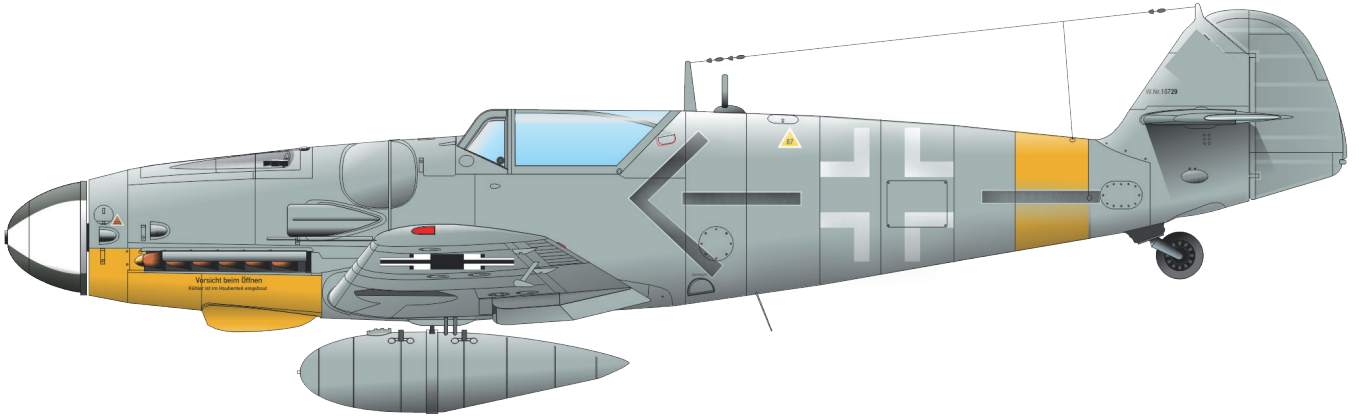
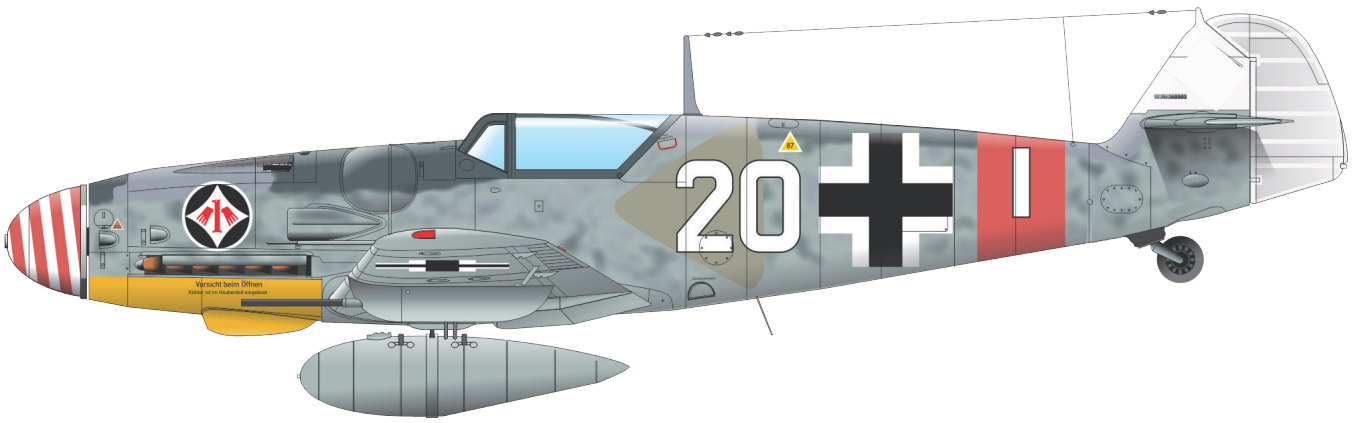

BUNDES/NATOfighter

eduard
LIMITED EDITION

Scale kit of F-104G in 48th scale in Limited edition based on Hasegawa plastic parts. Limited amount of 1000 kits only!

BASIC INFO:

NAME: **BUNDES/NATOfighter**

CAT. NO.: 1133

SCALE: 1/48

EDITION: Limited edition

CONTENTS:

SPRUES: Hasegawa

PE-SETS: Yes color

PAINTING MASK: Yes

MARKINGS: 10

BRASSIN: Seats

DECALS: Cartograf

RELATED PRODUCTS:

49073 F-104G seatbelts SUPERFABRIC (PE-Set)

49072 F-104G seatbelts FABRIC (PE-Set)

48833 F-104G upgrade set (PE-Set)

648181 F-104 undercarriage wheels late (Brassin)

648176 F-104 undercarriage wheels early (Brassin)

648175 F-104 exhaust nozzle late (Brassin)

648174 F-104 exhaust nozzle early (Brassin)

648234 F-104 pylons (Brassin)

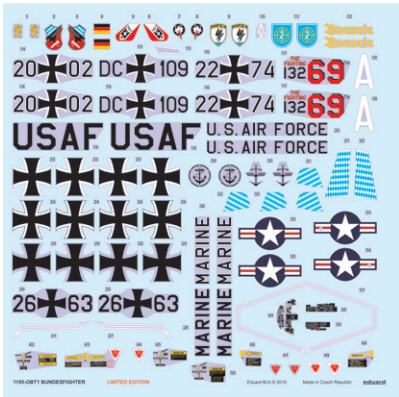
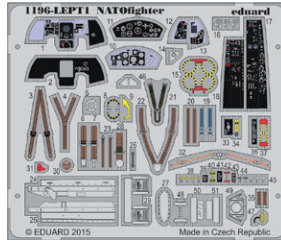
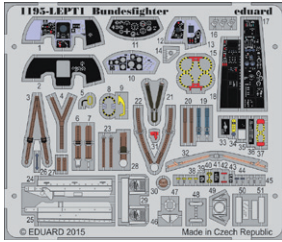
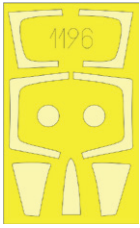

KIT PARTS

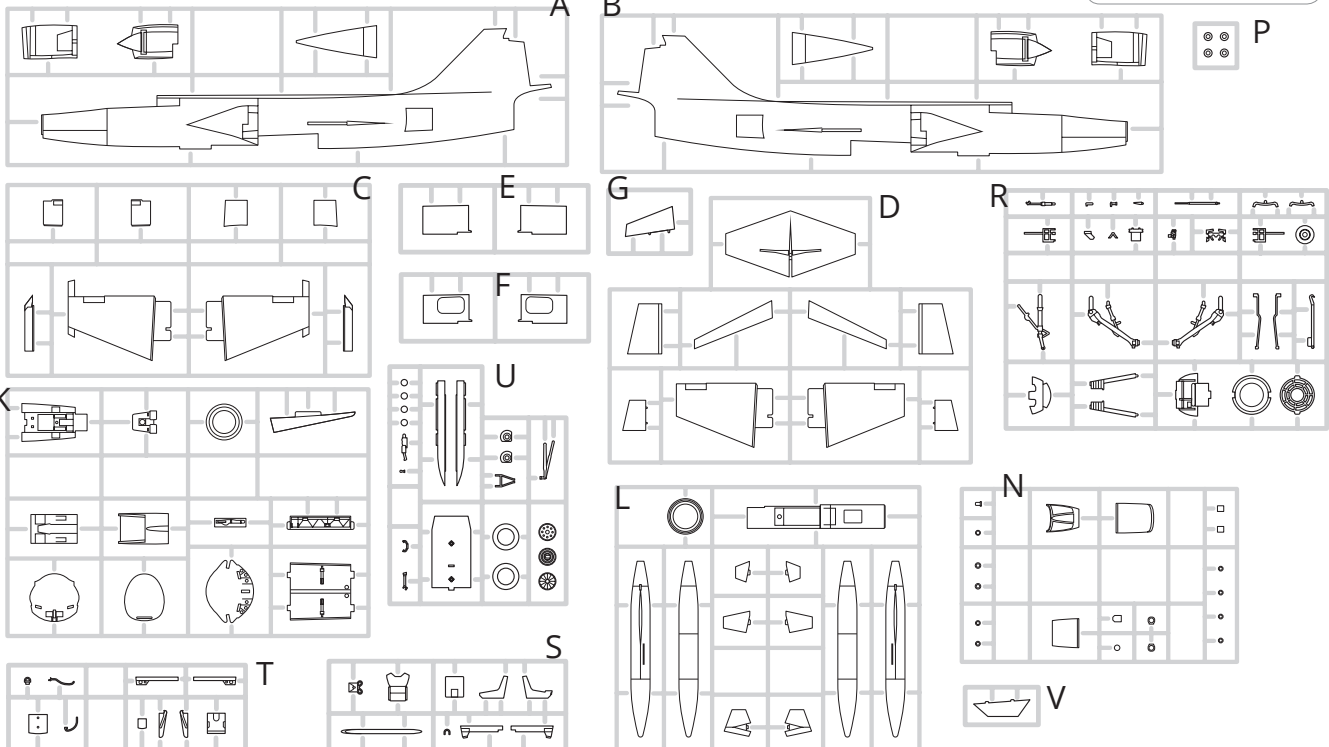

BUNDESfighter

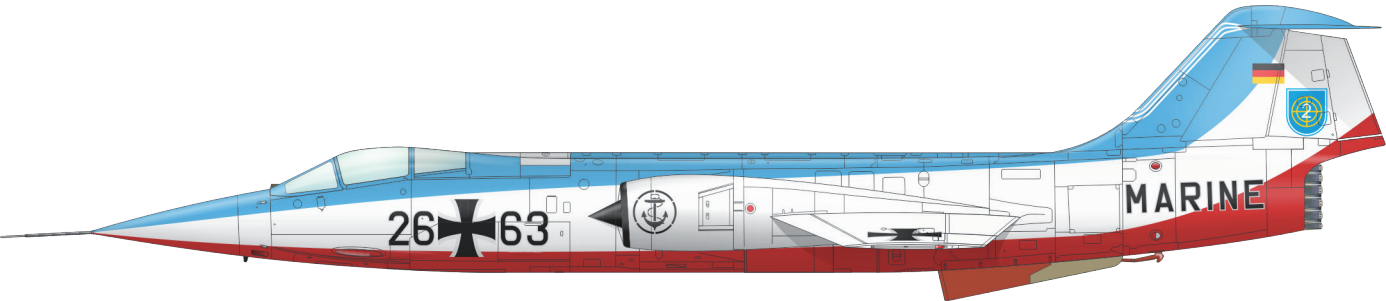
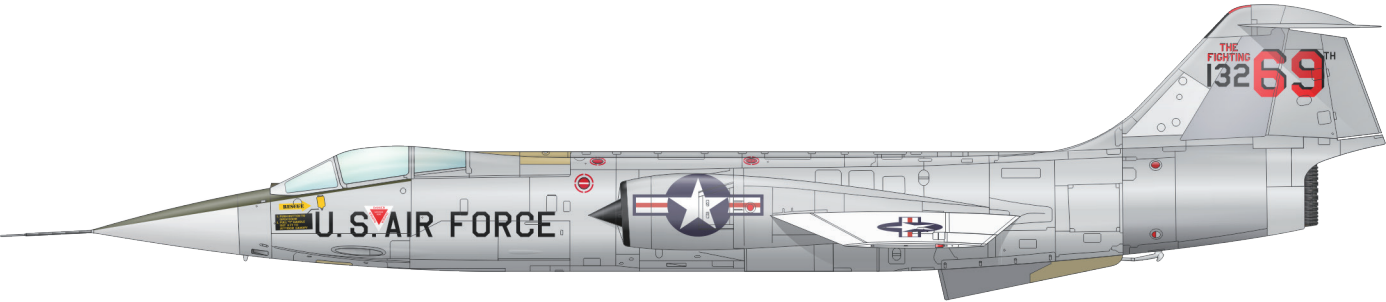
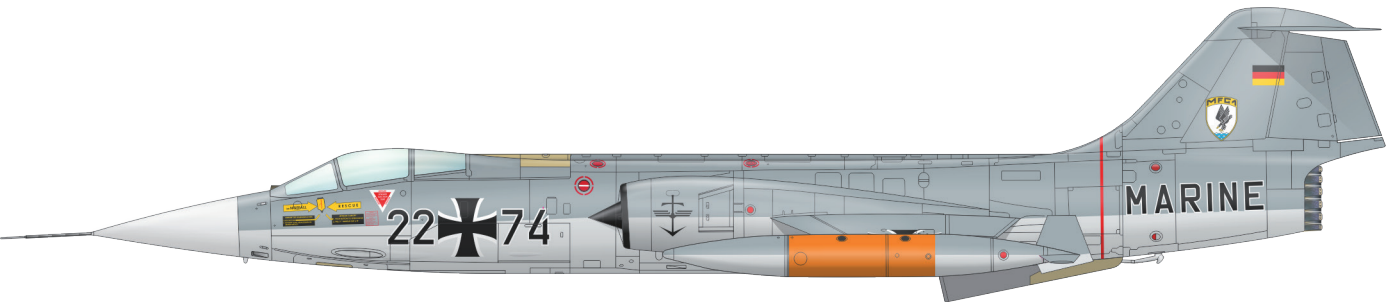
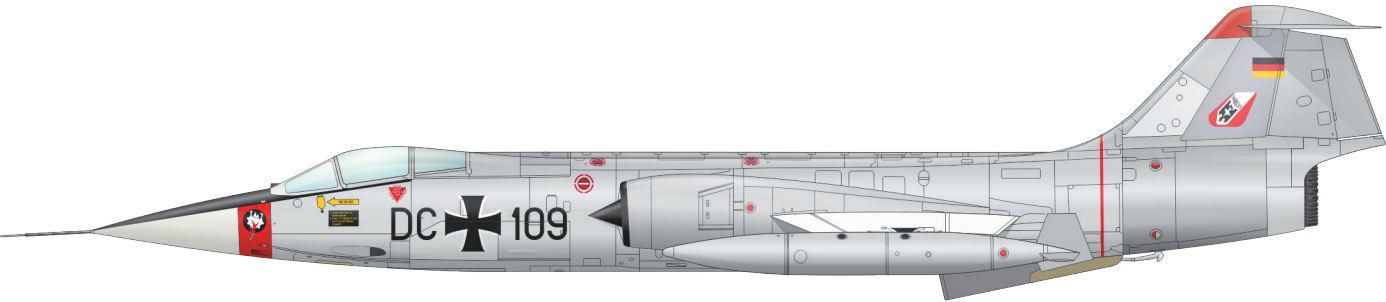
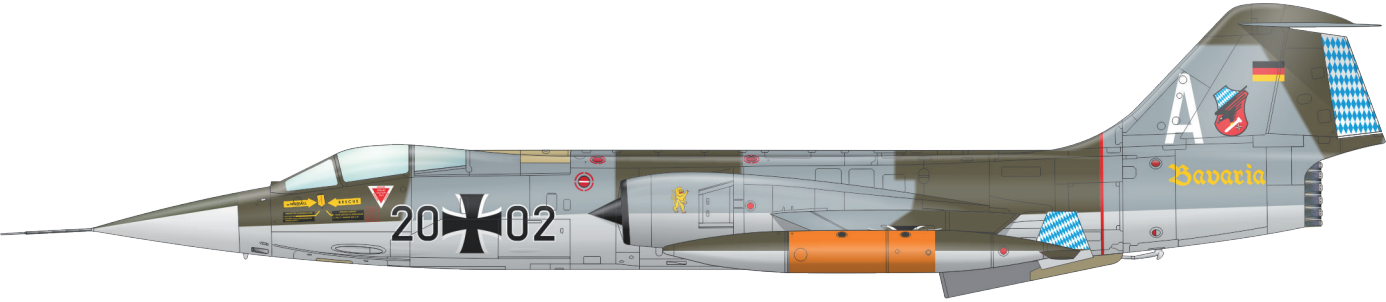

NATOfighter

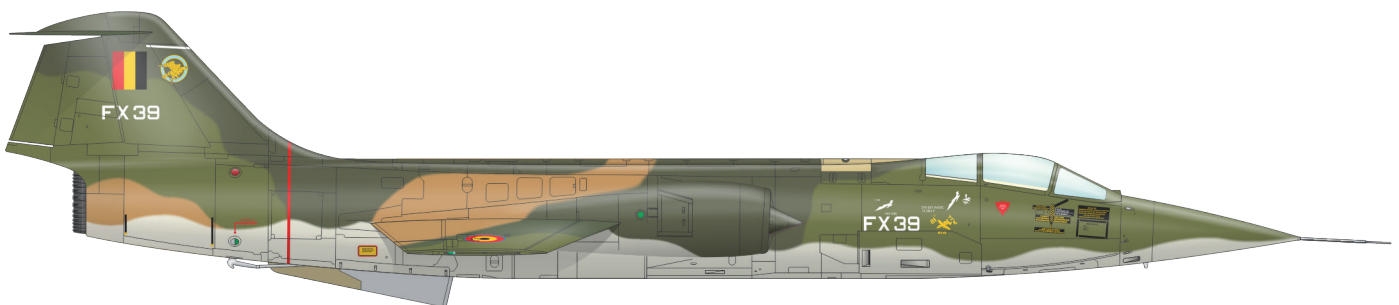
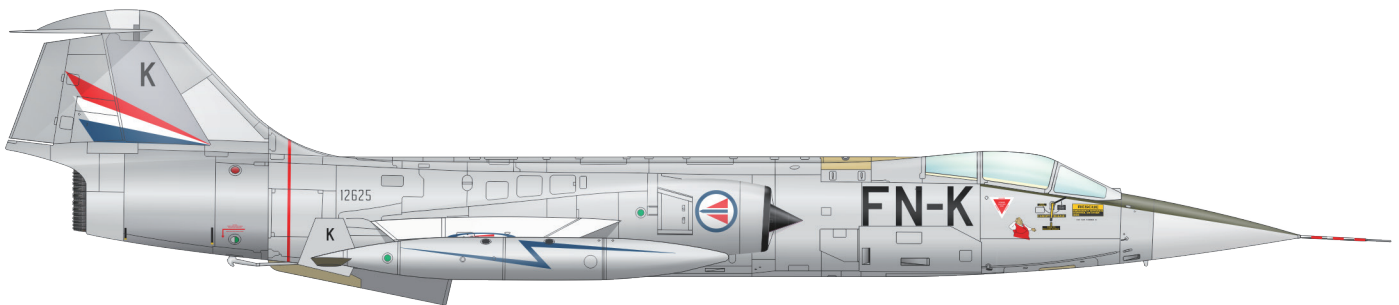
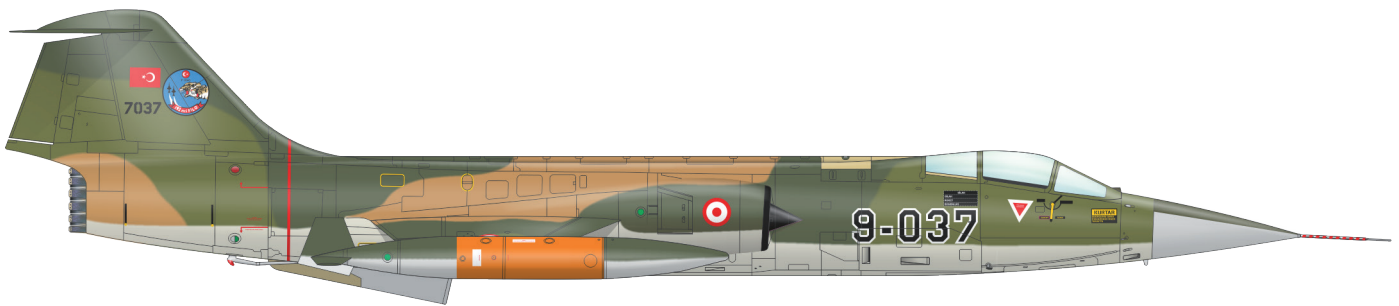
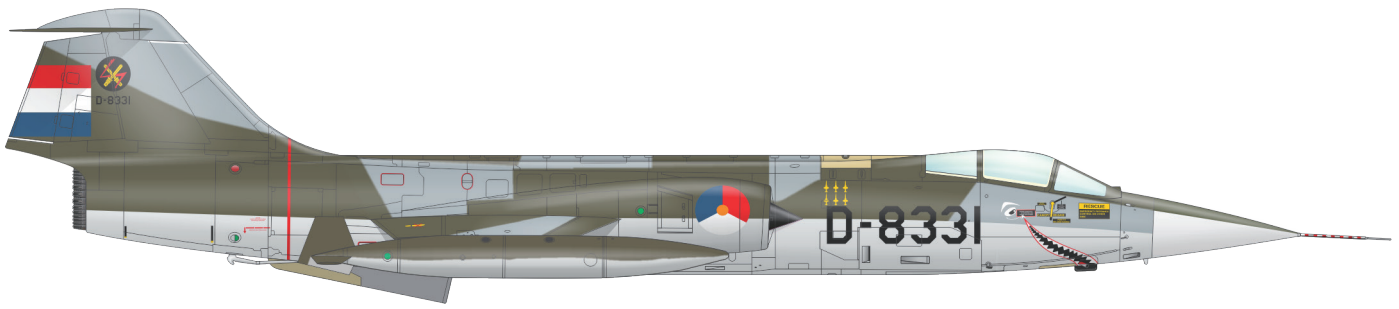

Fokker D.VII OAW

Scale kit of Fokker D.VII OAW in 48th scale in Weekend Edition.

BASIC INFO:

NAME: **Fokker D.VII OAW**

CAT. NO.: 84155

SCALE: 1/48

EDITION: Weekend edition

CONTENTS:

SPRUES: Eduard

PE-SETS: No

PAINTING MASK: No

MARKINGS: 2

DECALS: Eduard

RELATED PRODUCTS:

FE770 Fokker D.VII OAW Weekend (PE-Set)

EX513 Fokker D.VII OAW Weekend (Mask)

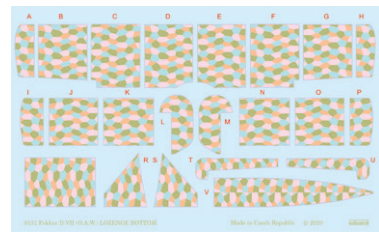
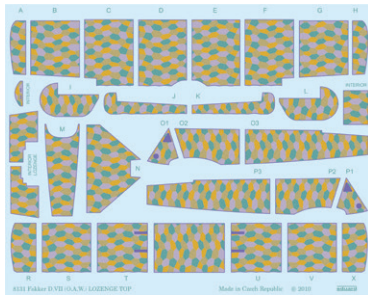
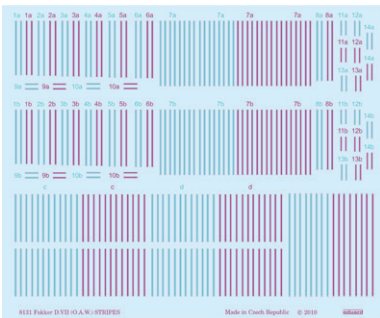
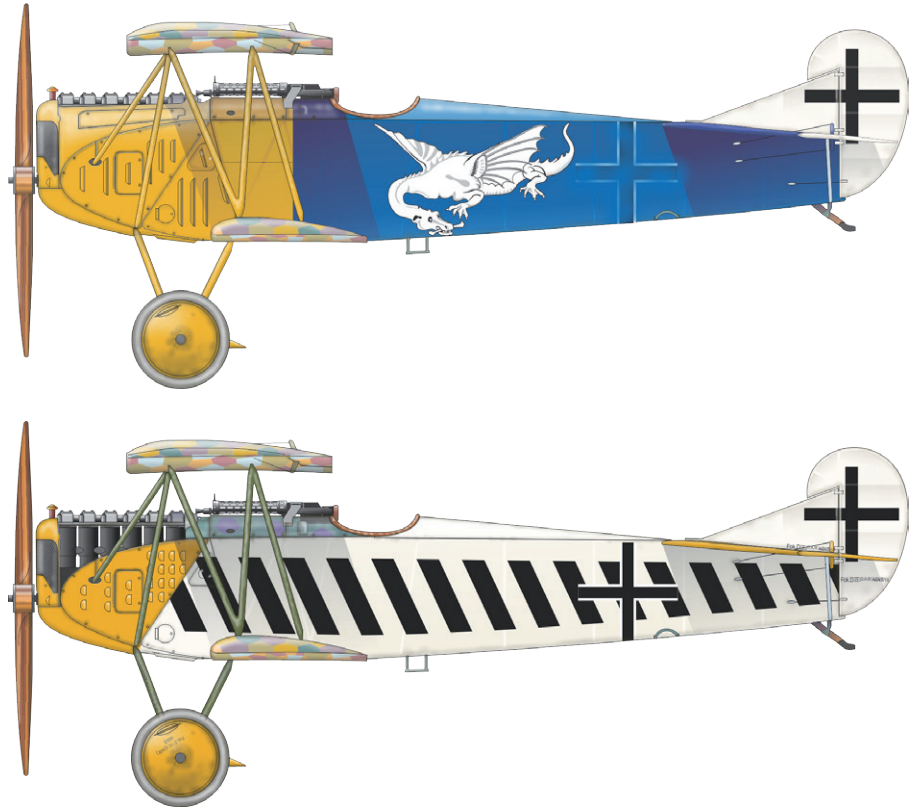

KIT PARTS

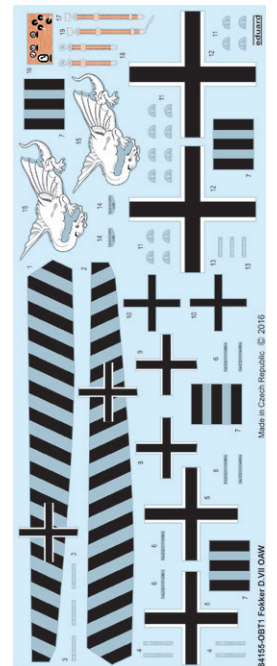
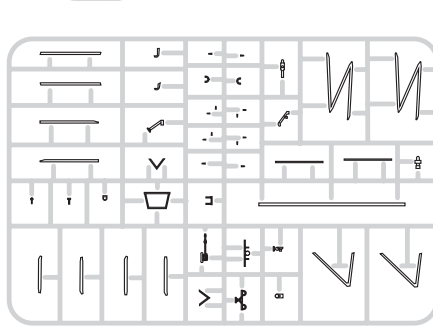
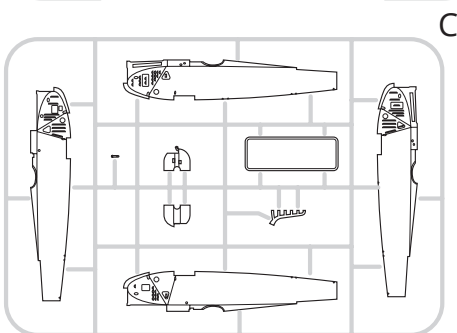
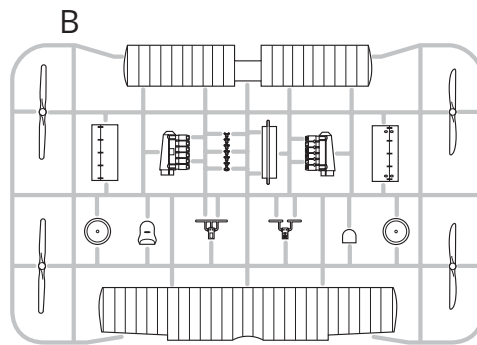
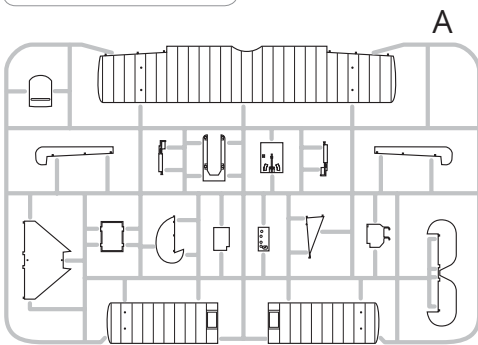

32863 A-6E TRAM interior
1/32 Trumpeter

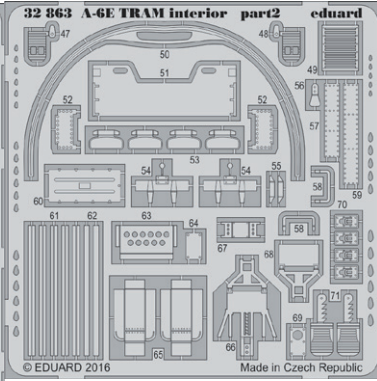
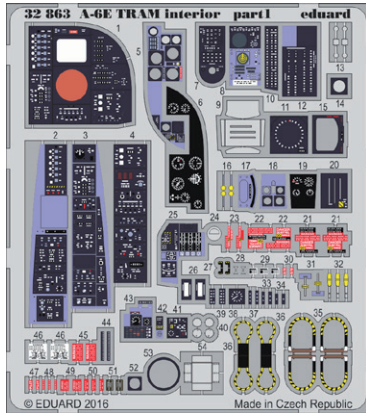

32864 A-6E TRAM seatbelts
1/32 Trumpeter

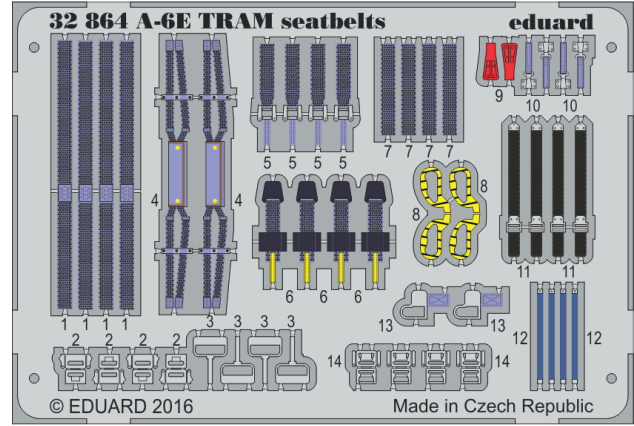

49766 J-29F Tunnar
1/48 Hobby Boss

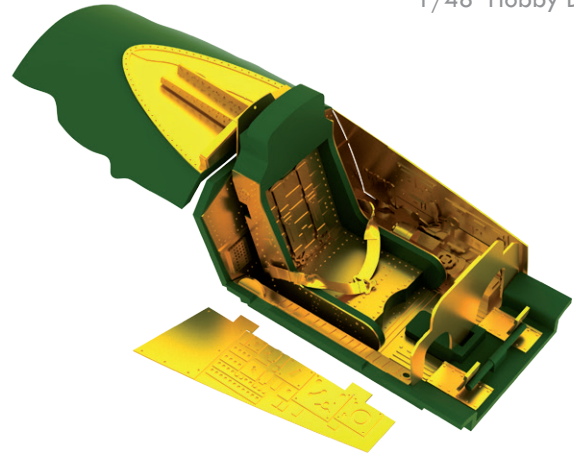

53158 German Submarine Type IX
C/40 hull pt. 1 1/72 Revell

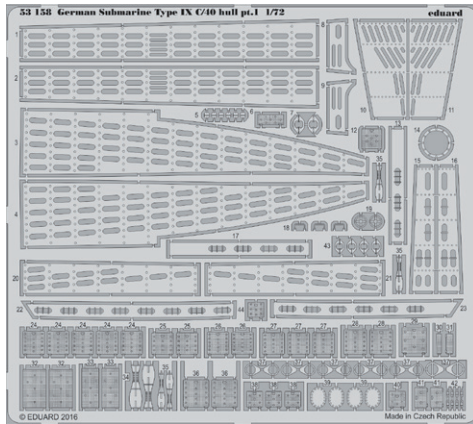

53159 German Submarine Type IX
C/40 hull pt. 2 1/72 Revell

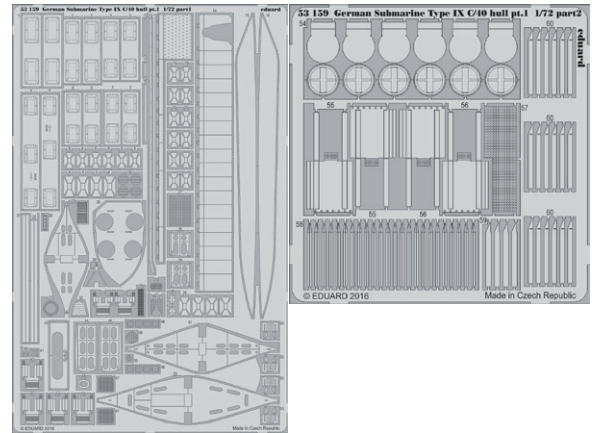

53160 German Submarine Type IX
C/40 tower 1/72 Revell

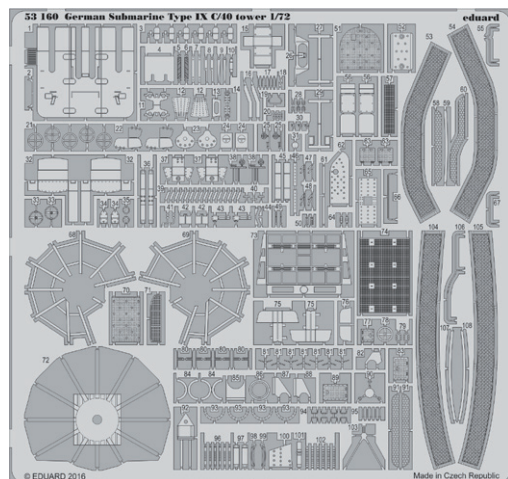

53161 IJN Kagero pt.1
1/350 Tamiya

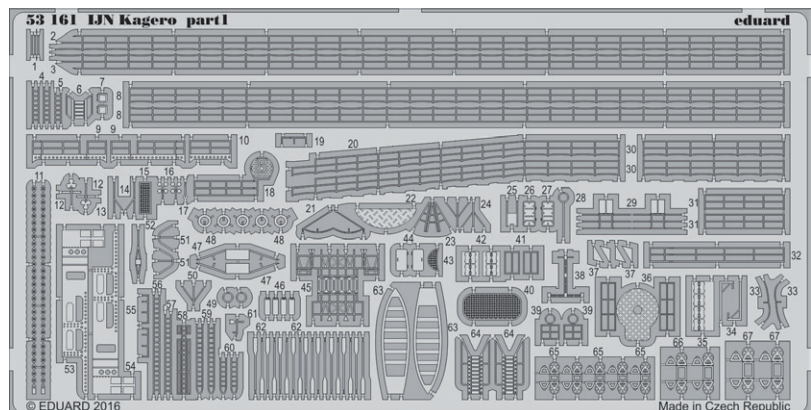

53162 IJN Kagero pt.2
1/350 Tamiya

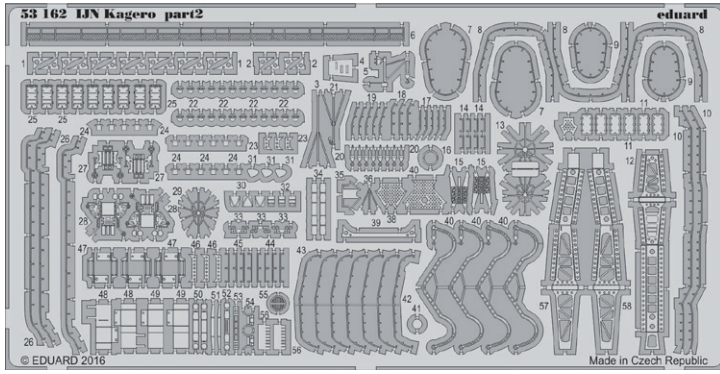

33157 A-6E TRAM interior
1/32 Trumpeter

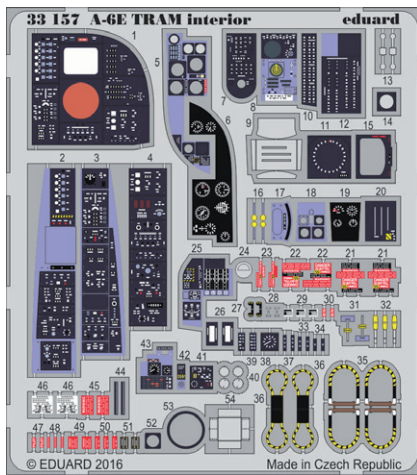

FE766 J-29F Tunnan
1/48 Hobby Boss

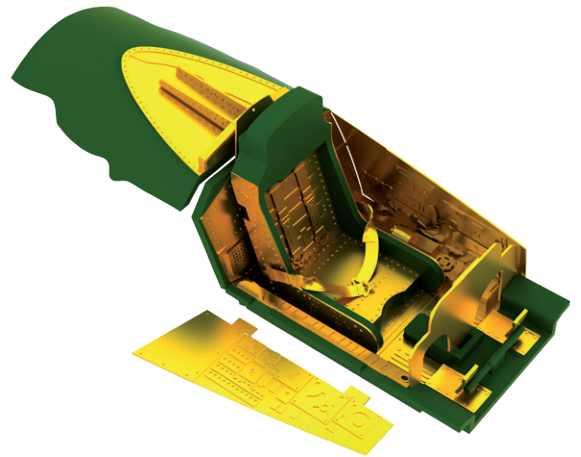

JX190 A-6E TRAM
1/32 Trumpeter

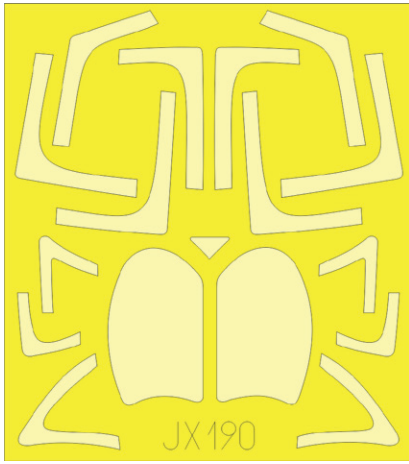

EX498 Meteor F.8
1/48 Airfix

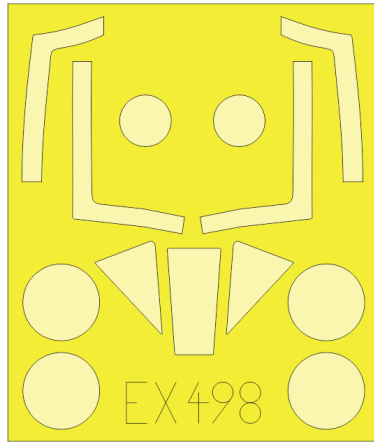

EX499 J-29 Tunnan
1/48 Hobby Boss

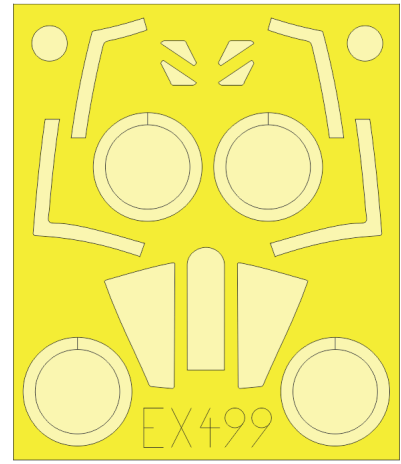

EX507 Me 262B-1a/U1
1/48 Hobby Boss

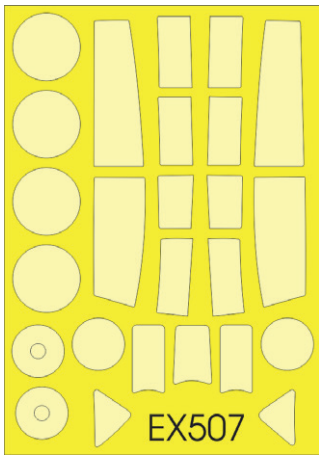

EX508 Sea Harrier FRS.1
1/48 Kinetic

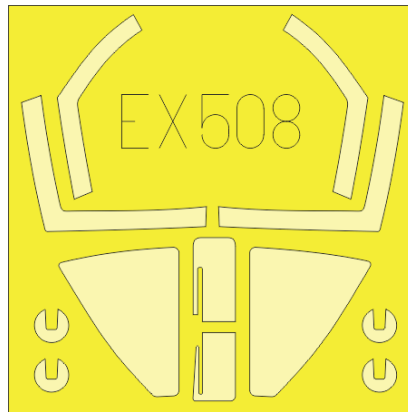

EX512 Bf 109G spinner spirals
1/48 Eduard



EX509 Bf 109G camo scheme -
Mtt 1/48 Eduard



EX510 Bf 109G camo scheme -
Erla 1/48 Eduard



EX511 Bf 109G camo scheme -
WNF 1/48 Eduard

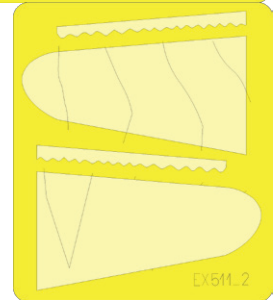
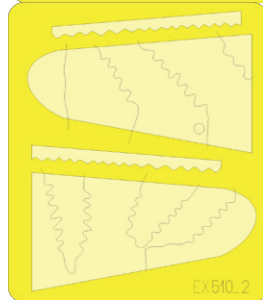
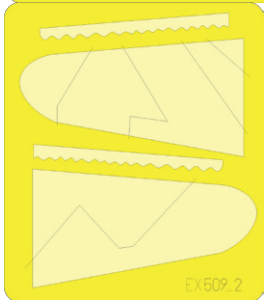
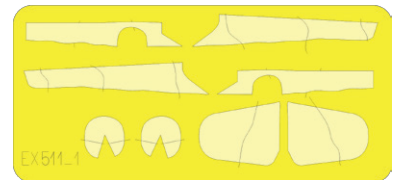

EX513 Fokker D.VII OAW Weekend
1/48 Eduard

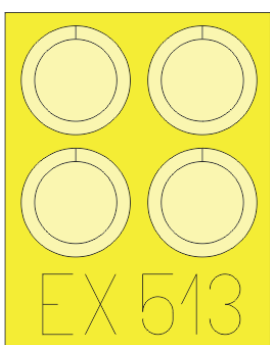

CX444 Sea Vixen FAW.2
1/72 Cyber Hobby

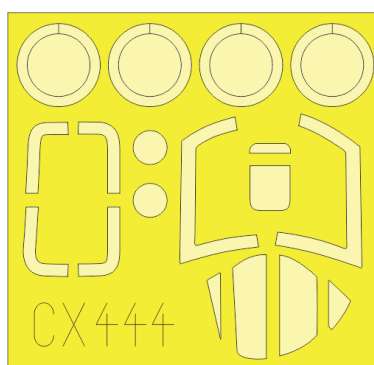

632072 GBU-12 bomb 1/32

Brassin set 4 pieces of GBU-12 guided bombs in 72nd scale.

Set contains:

- resin: 32 parts
- decals: yes
- photo-etched details: yes
- painting mask: no

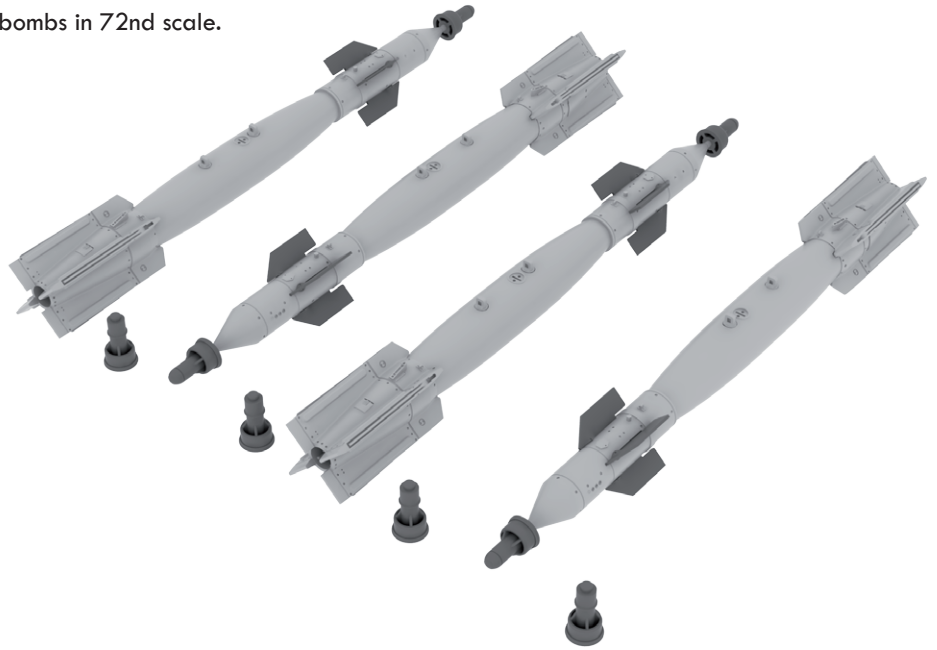

632078 Mosquito FB Mk.VI gun bay 1/32 Tamiya

Brassin set of 4 complete Mosquito FB Mk.VI cannons including magazines for the lower gun bay in 32nd scale for kit by Tamiya.

Set contains:

- resin: 34 parts
- decals: yes
- photo-etched details: no
- painting mask: no

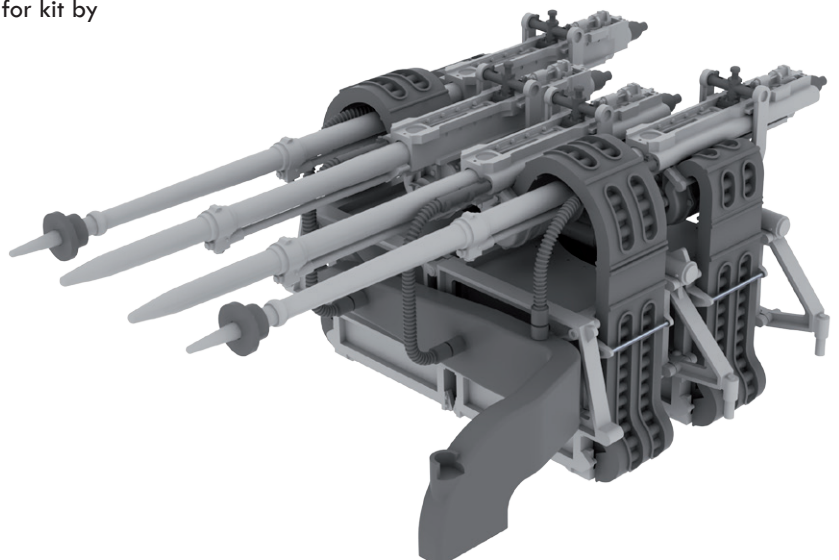

648239 Bf 109G-6 radio compartment 1/48 Eduard

Brassin set of Bf 109G-6 radio compartment in 48th scale for Eduard kit.

Set contains:

- resin: 6 parts
- decals: no
- photo-etched details: yes
- painting mask: no

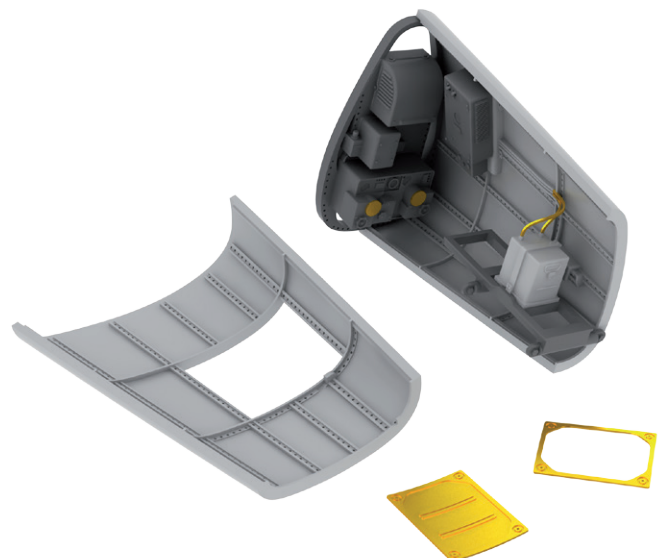

648240 Bf 109G-6 cockpit 1/48 Eduard

Cockpit Brassin set for Bf 109G-6 in 48th scale for Eduard kit.

Set contains:

- resin: 24 parts
- decals: yes
- photo-etched details: yes
- film: yes
- painting mask: no

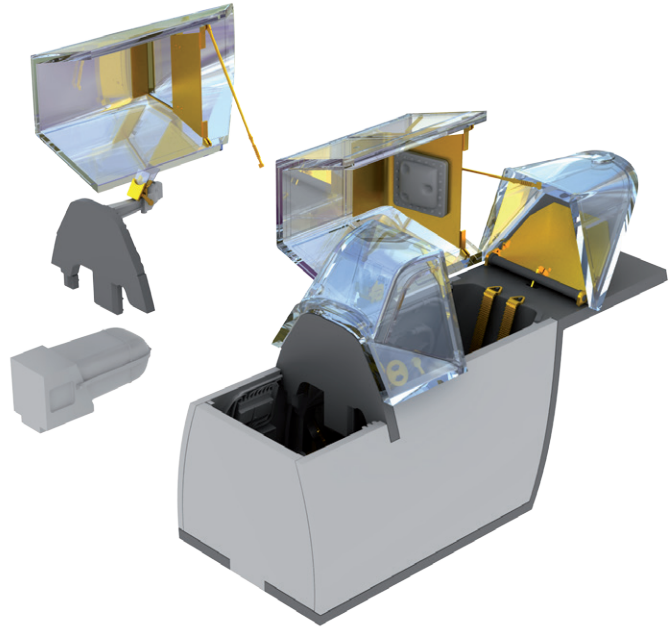

648245 W.Gr.21 for Bf 109 1/48 Eduard

Brassin of 2 pieces of W.Gr.21 rocket launchers in 48th scale for kit by Eduard.

Set contains:

- resin: 16 parts
- painting mask: no
- decals: no
- photo-etched details: yes

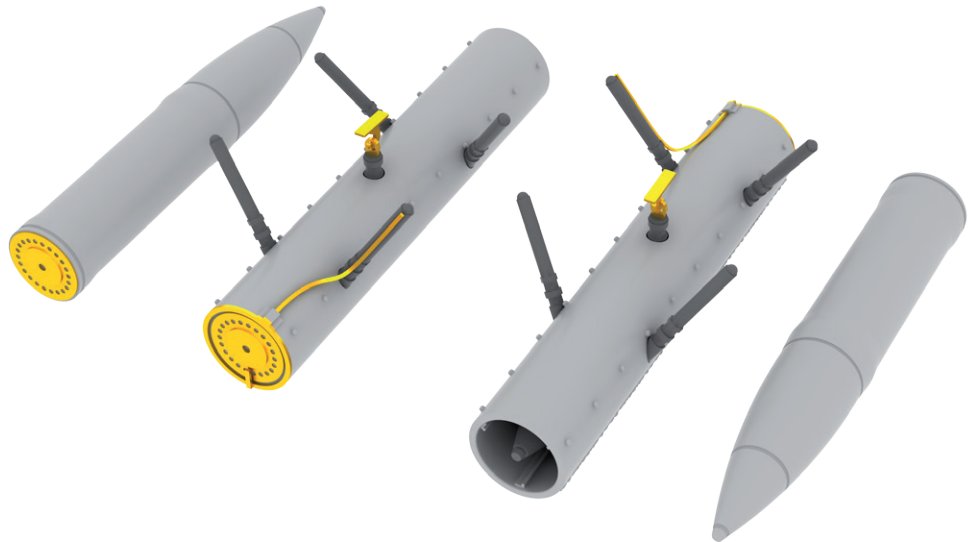

648246 Bf 109 cannon pods 1/48 Eduard

Brassin set of 2 pieces of Bf 109 cannon pods in 48th scale for kit by Eduard.

Set contains:

- resin: 12 parts
- decals: no
- photo-etched details: yes
- painting mask: no

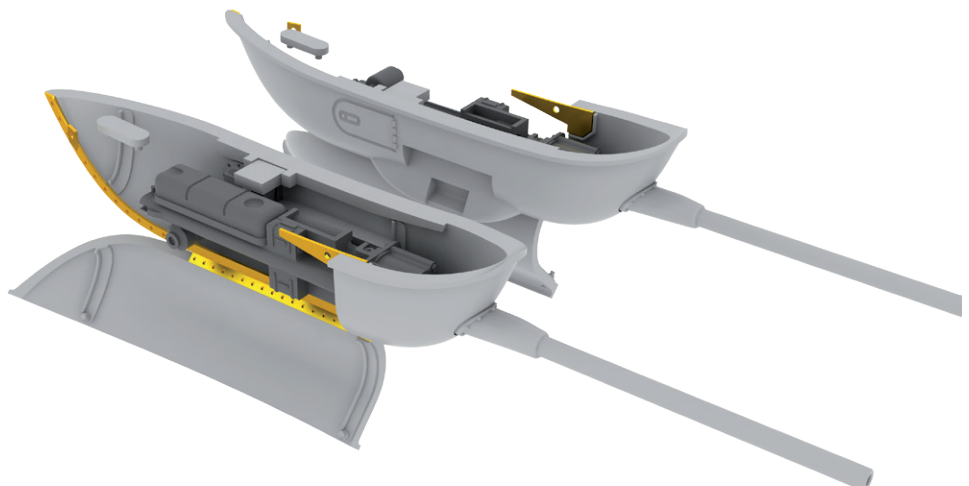

648247 Bf 109G exhaust stacks 1/48 Eduard

Brassin set of Bf 109G exhaust stacks in 48th scale for kit by Eduard.

Set contains:

- resin: 4 parts
- decals: no
- photo-etched details: yes
- painting mask: no



648248 MiG-31 wheels 1/48 AMK

Brassin set of MiG-31 wheels in 48th scale for kit by AMK. Set includes 4 main wheels and 2 front wheels with mudguard.

Set contains:

- resin: 11 parts
- decals: no
- photo-etched details: no
- painting mask: yes



648253 F-4J wheels 1/48 Academy

Brassin set of F-4J wheels in 48th scale for kit by Academy. Set includes 2 front wheels and 2 main wheels.

Set contains:

- resin: 4 parts
- decals: no
- photo-etched details: no
- painting mask: yes



648254 F-4J exhaust nozzles 1/48 Academy

Brassin set of 2 pieces of F-4J exhaust nozzles in 48th scale for kit by Academy.

Set contains:

- resin: 6 parts
- decals: no
- photo-etched details: yes
- painting mask: no



672102 UB-16 rocket pods 1/72

Brassin set of 4 pieces of UB-16 rocket pods in 72nd scale.

Set contains:

- resin: 8 part
- decals: yes
- photo-etched details: yes
- painting mask: no

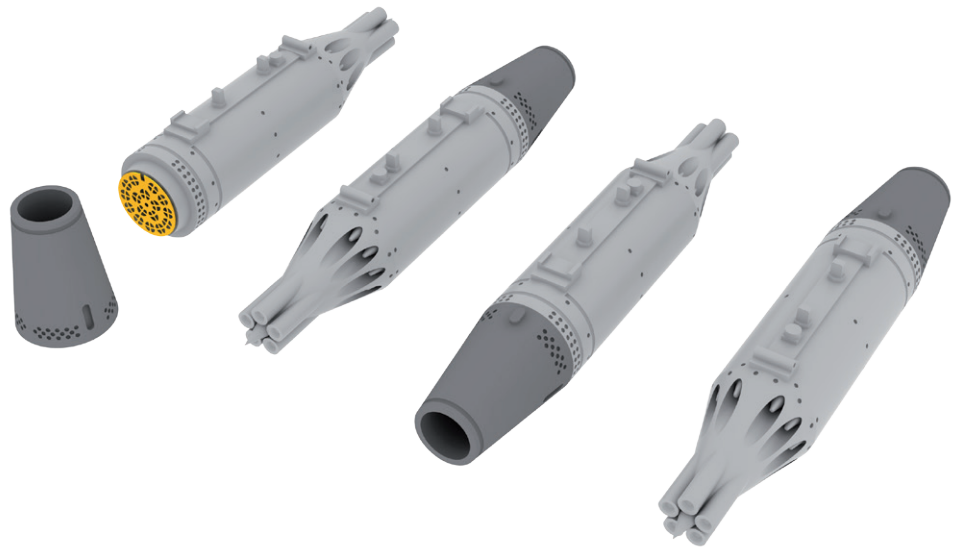

672103 UB-32 rocket pods 1/72

Brassin set of 4 pieces of UB-32 rocket pods in 72nd scale.

Set contains:

- resin: 12 parts
- decals: yes
- photo-etched details: yes
- painting mask: no





BIGSIN collection containing 4 individual Brassin sets and painting mask for MiG-29A Izdeliye 9-12 in 72nd scale by Trumpeter.

- wheels,
- exhaust nozzles,
- cockpit,
- weapon set,
- painting mask.

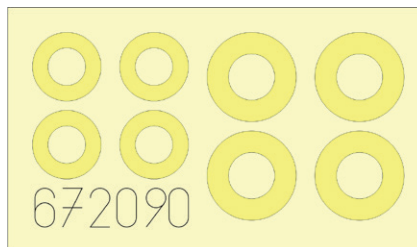

All sets included in this BIG SIN are available separately, but with every BIG SIN set you save up to 30%.

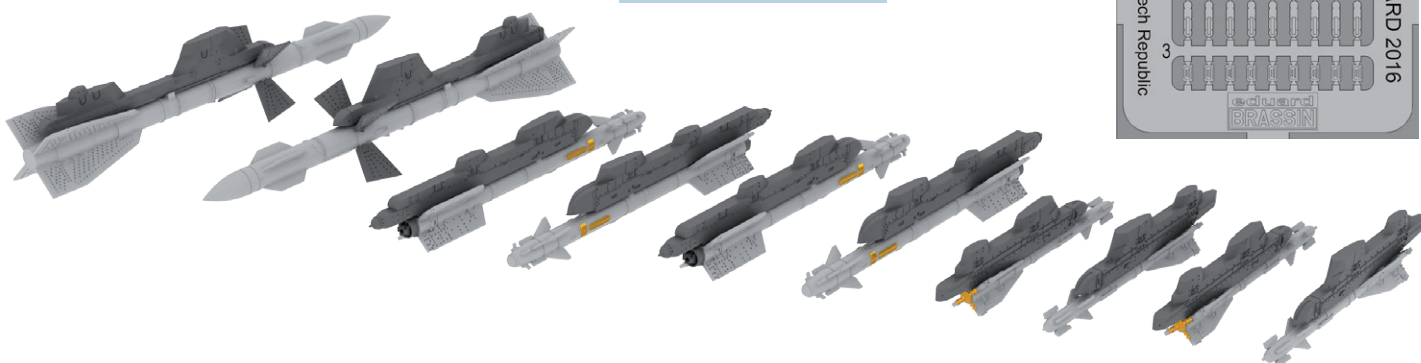
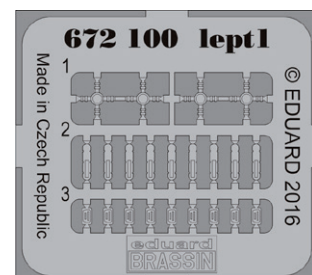
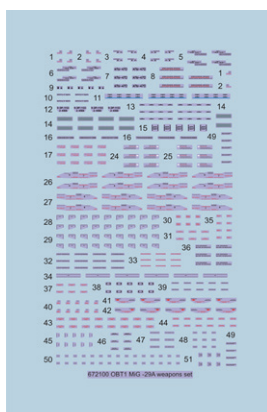
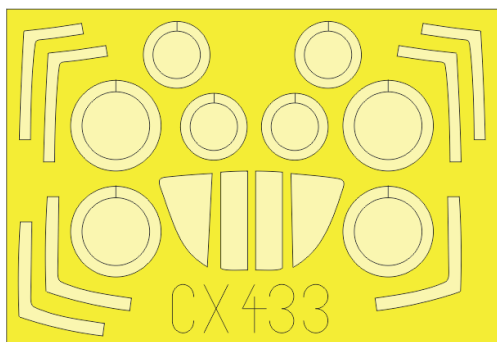
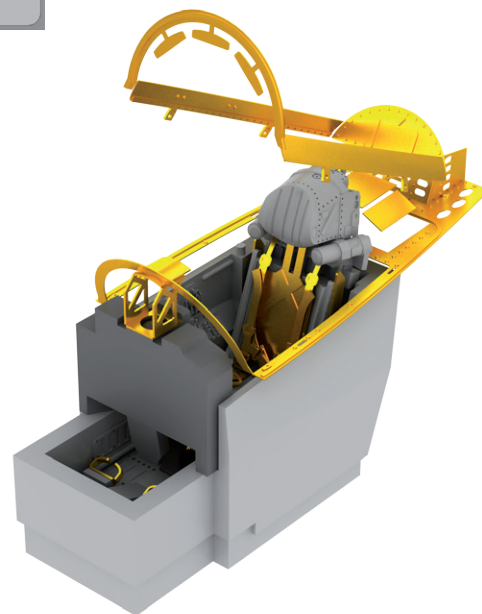
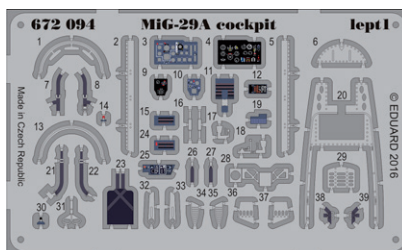
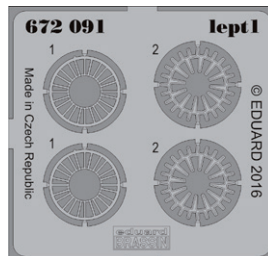
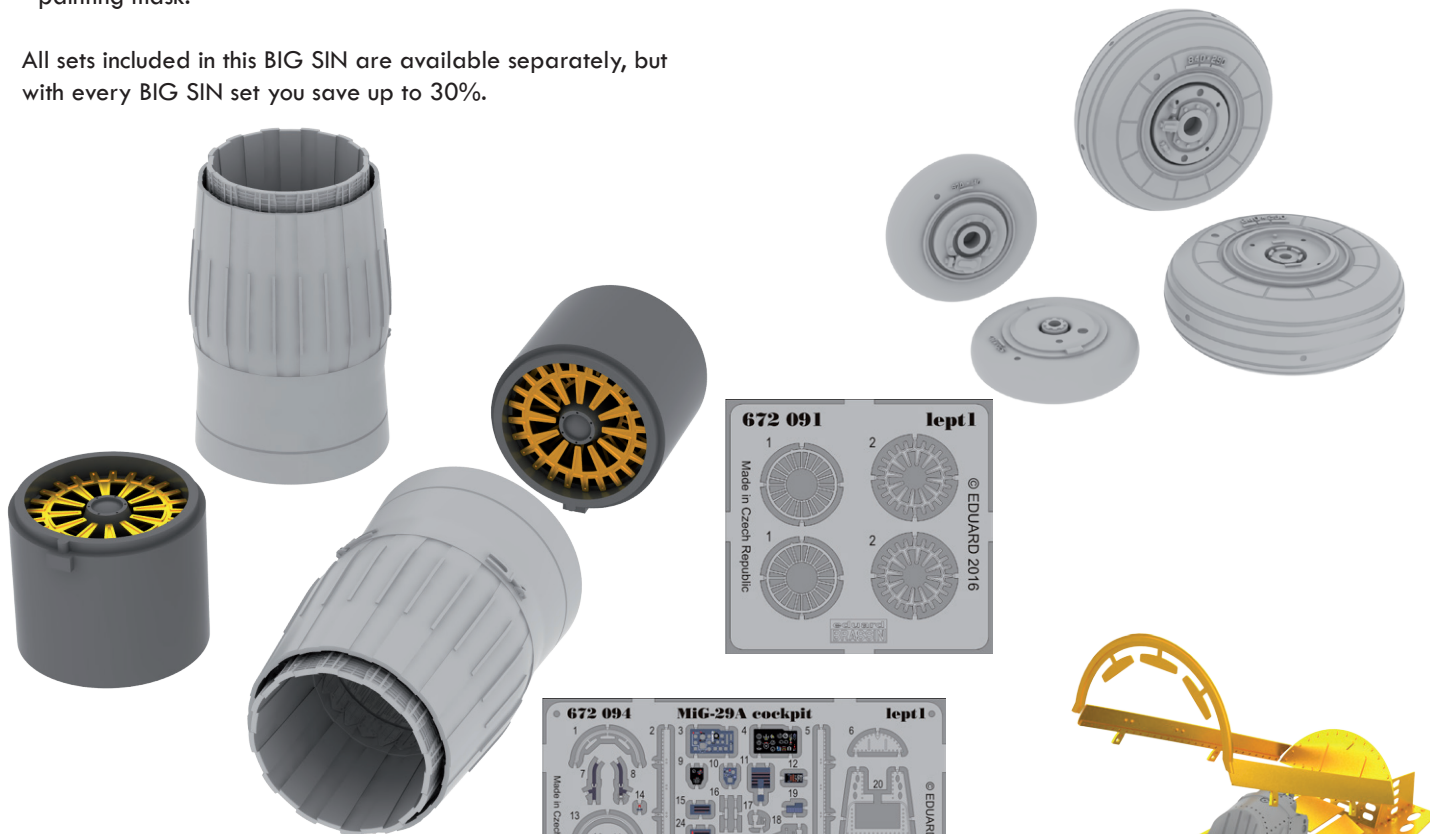

BIG5335 Z-32 destroyer 1/350 Dragon

- 53151 Z-32 destroyer
- 53152 Z-32 destroyer railings
- 17516 Figures Kriegsmarine WWII S.A. 3D
- 17516 Figures Kriegsmarine WWII S.A. 3D

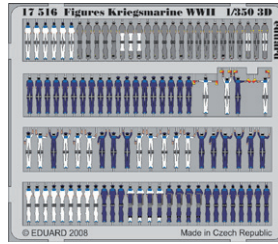
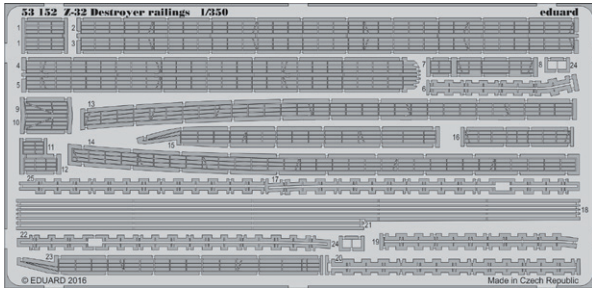
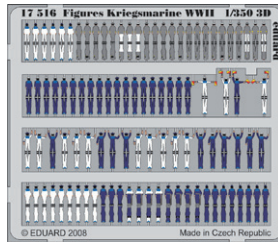
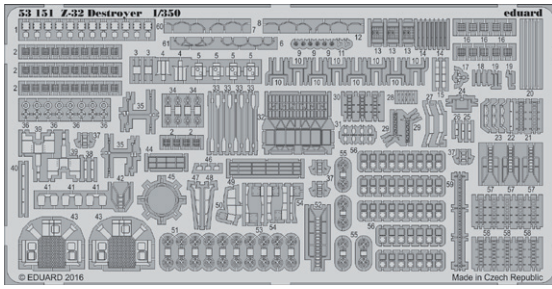

BIG3360 A.S. 51 Horsa Glider Mk.I 1/35 BroncoModels

- 32384 A.S. 51 Horsa Glider Mk.I landing flaps
- 32855 A.S. 51 Horsa Glider Mk.I interior
- 32856 A.S. 51 Horsa Glider Mk.I cargo seatbelts
- JX187 A.S. 51 Horsa Glider Mk.I

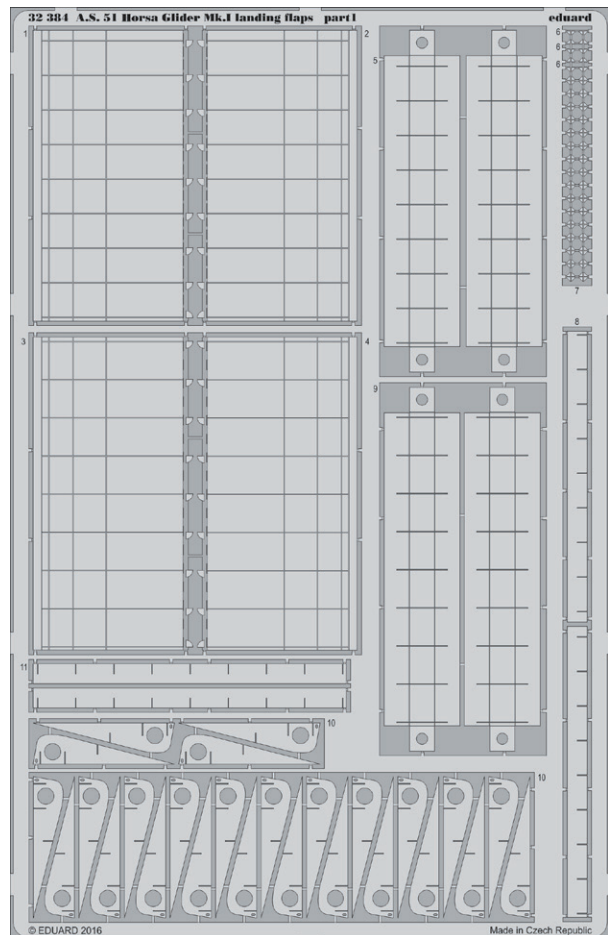
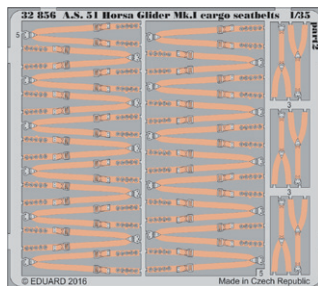
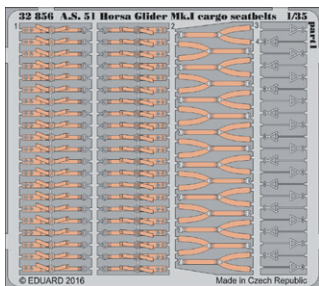
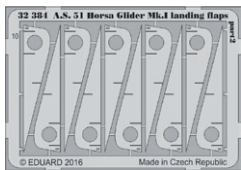
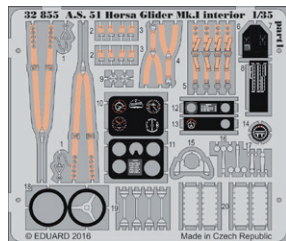
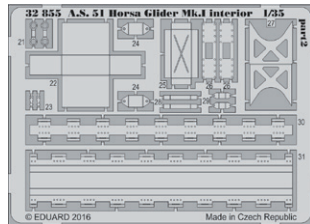
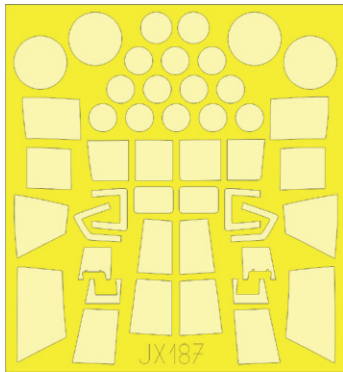

- 32382 P-39Q/N landing gear
- 32852 P-39Q/N seatbelts
- 32853 P-39Q/N interior

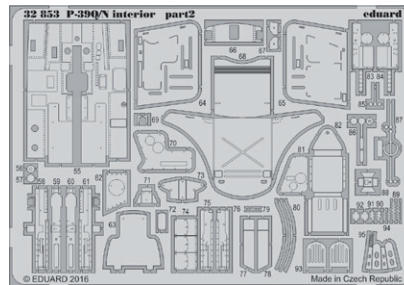
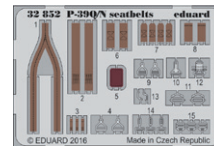
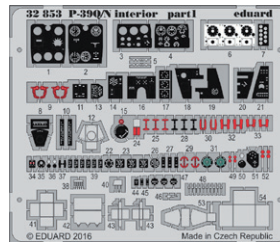
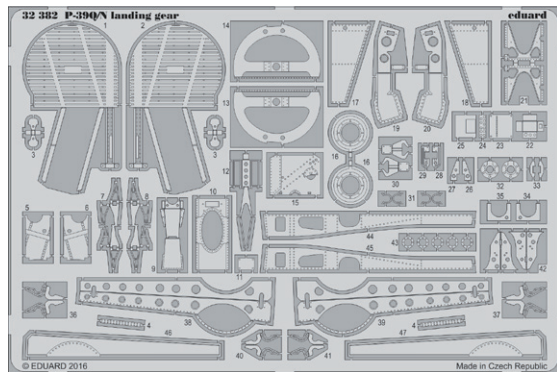

BIG49146 Pe-2 1/48 Zvezda

- 48871 Pe-2 exterior
- 49747 Pe-2 interior
- EX488 Pe-2

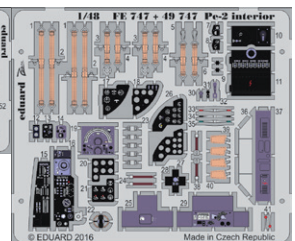
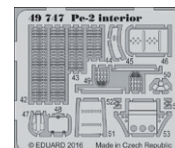
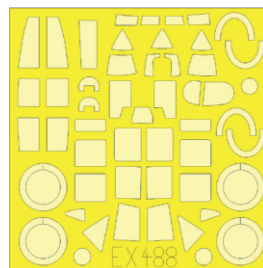
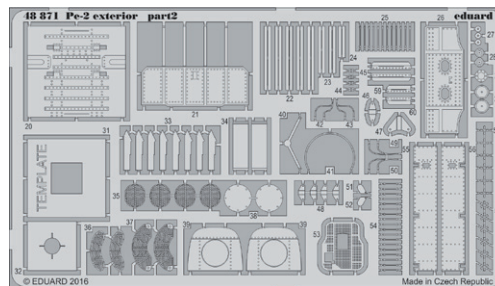
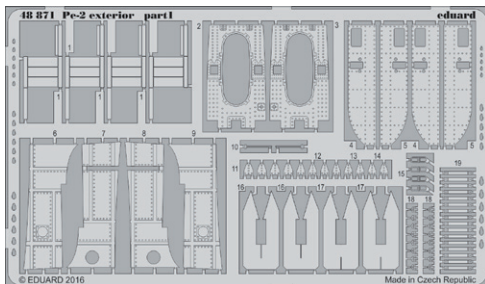

BIG72108 MiG-29A Izdeliye 9-12 1/72 Trumpeter

- 73541 MiG-29A Izdeliye 9-12
- CX433 MiG-29A Izdeliye 9-12

