



INFORMACE PRO DISTRIBUTORY

PROSINEC 2015

Vážení přátelé,

V dnešním newsletteru vám představujeme jednu z nejatraktivnějších sestav novinek, jakou se nám letos podařilo připravit. Ostatně, prosinec a předvánoční prodej je pro snahu o zajímavou nabídku dobrým motivem.

Základem prosincové sestavy novinek jsou opět modely. Čtveřice novinek má mezi sebou dvě položky vydávané v konfiguraci QUATTRO COMBO, obsahující čtyři kompletní kity v balení. Tuto konfiguraci používáme v poslední době pro položky řady ROYAL CLASS v měřítku 1/72 a část položek řady SUPER44 v měřítku 1/144. V prosinci se tato konfigurace týká položky 4451 AVIA B-534 EARLY SERIES 1/144 a R0012 Fw 190A-8 1/72. Především u R0012 věříme, že zopakuje prodejní úspěch svého předchůdce v měřítku 1/48, vydaného před osmi lety, s nímž sdílí řadu prvků. To se týká především typu, ze stavebnice lze postavit Fw 190A-8 se standardním i tzv. univerzálním křídlem a pancéřovanou verzí Fw 190A-8/R2 s 30mm kanóny MK108 v křídle. Oproti svému většímu předchůdci tato stavebnice obsahuje i díly pro noční radarovou stíhačskou verzi Fw 190A-8/R11, pro kterou je v nabídce markingů vyhrazen jeden z nich. Markingů je celkem 12 a jak jistě uznáte, jsou velice atraktivní a pestré. Sestava plastových rámečků obsahuje jeden speciální rámeček navíc, který řeší některé specifické prvky výzbroje některých nabízených markingů. V tomto rámečku najdete křídlo bez boulí na horní ploše křídla nad závěry kanónů MK 108, charakteristické pro tzv. univerzální křídlo. Na spodní ploše křídla jsou potom kryty kanónů bez boule pro stroje, které měly vnější křídelní kanóny odstraněny. Další specifické detaily jsou řešeny leptem. Doufáme, že tato sestava plastových dílů, pokrývající velkou škálu variant tohoto stroje, uspokojí i velké znalce a odborníky. Pokud ne, budeme mít alespoň čisté svědomí, že jsme o to, byť marně, pokusili. Lepty, resinové díly a masky jsou u této řady víceméně standardem, model ovšem obsahuje ještě dva speciální bonusy, jednak pívni skleničku, která může být v modelu v jedné ze šesti podob, a těžitko s kouskem plechu z Fw 190A-8/R2, sestřelené nad Kovářskou v Krušných Horách 11. září 1944.

Druhým Quattro combem je Avia B-534 EARLY SERIES 1/144. Model obsahuje čtyři sady výlisků, po jednom pro Avii B-534 I. série, II. série, III. série a III. série s krytem kabiny. Tentokrát nehýříme markingy, je jich celkem šest.

Pak je tu F-86F-30 Sabre 1/48 vydávaný v řadě LIMITED EDITION pod názvem ULTIMATE SABRE, výlisky Hasegawa, obtisky Cartograf, lepty, maska, Brassiny vše Eduard, markingů je celkem pět. Tento model vydáváme v sérii 3000 kusů, lze předpokládat, že vzhledem k atraktivitě předlohy, kvalitě modelu i zpracování doplňků je šance na další bestseller této řady. Také Spitfire Mk.VIII 1/48 v řadě WEEKEND patří k tomu nejlepšímu, co jsme dosud v této produktové řadě vydali.

Pro všechny tyto nové modely najdete v nabídce i doplňky. Pro Fw 190A-8 už jich byla řada vydaná v říjnu, nyní nabídku doplňků pro tento model rozšiřujeme o tři Brassinové sady pro motor, další sada obsahuje kombinaci motoru a instalace trupových zbraní, poslední, třetí sada pak vrtulí s kuželem a ventilátorem. Pro Avii B-534 máme lepty, stejně jako pro F-86F a Spitfira Mk.VIII, pro Spitfira nabízíme i novou masku. To samozřejmě není celá nabídka doplňků, ve všech produktových řadách najdete další atraktivní položky. Nebudu vás zatěžovat jejich rozpisem, najdete je dále v tomto materiálu. Tento měsíc se nám podařilo již do leafletu dostat obrázky pro významnou část uváděných novinek, což vám dává řadu příležitostí k jejich důkladnému studiu.

Přátelé, prosincové novinky budou pro české zákazníky k dispozici od 20. listopadu. Listopadové novinky budou uvolněny k prodeji v ČR k 23. říjnu. Přeji Vám inspirativní čtení našeho newsletteru, skvělý předvánoční prodej a těšíme se na vaše objednávky. Pokud si novinky předobjednáváte, připomínám, že poslední termín pro příjem předobjednávek na prosincové novinky je 31. říjen.

Díky za pozornost a těšíme se na další spolupráci!

Vladimír Šulc

Návody, více fotografií a informací
naleznete na www.eduard.com

Tento leták je volně stažitelný na www.eduard.com.

eduard

NOVINKY PROSINEC 2015

RYCHLÝ NÁHLED
PRO DETAIL KLIKNĚTE NA TLAČÍTKO

PLASTIKOVÉ MODELY



84139 **Spitfire Mk.VIII**
1/48 Weekend

DETAIL



4451 **Avia B.534**
1/144 SUPER44

DETAIL



1163 **Ultimate Sabre**
1/48 Limited edition

DETAIL



R0012 **Fw 190A-8**
1/72 Royal Class

DETAIL

MASKY

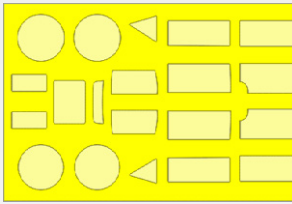

CX429 **B5N2 Kate**
1/72 Airfix

DETAIL



CX430 **Su-24MR**
1/72 Trumpeter

DETAIL

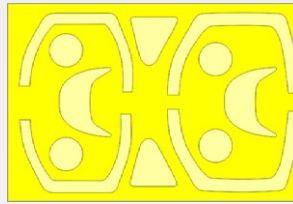

CX431 **Jaguar E**
1/72 Hobby Boss

DETAIL



CX432 **F4F-4**
1/72 Airfix

BEZ NÁHLEDU

DETAIL

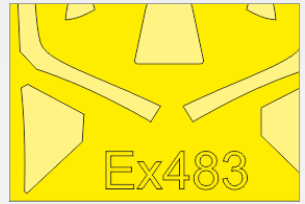

EX483 **Spitfire Mk.VIII**
1/48 Eduard

DETAIL

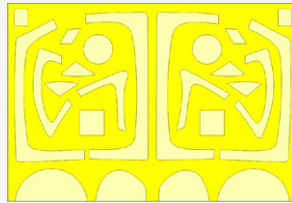

EX484 **A-6E TRAM**
1/48 Hobby Boss

DETAIL

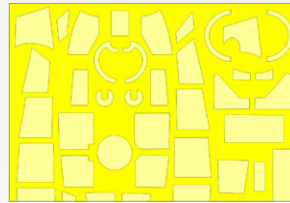

EX485 **Do 215B-5 Nighthunter**
1/48 ICM

DETAIL

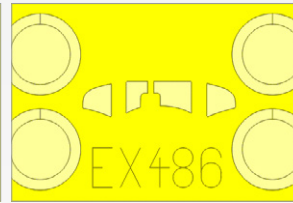

EX486 **He 51B.1**
1/48 Roden 452

DETAIL

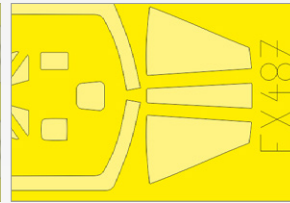

EX487 **Mirage III E**
1/48 Kinetic

DETAIL

BIG-ED SETS



BIG5331 **HMS DREADNOUGHT**
1915 1/700 Trumpeter

DETAIL



BIG3357 **Ju 87G-2**
1/32 Trumpeter

DETAIL

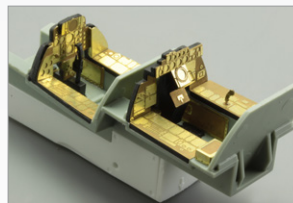

BIG49137 **F-4D**
1/48 Academy

DETAIL



BIG49138 **UH-1Y**
1/48 KittyHawk

DETAIL

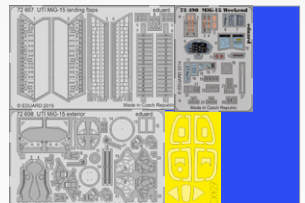

BIG72104 **UTI MiG-15**
1/72 Eduard

DETAIL

FOTOLEPTY

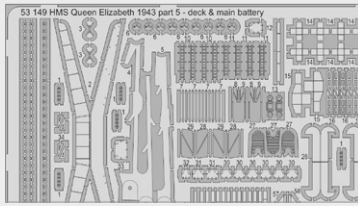

53149 HMS Queen Elizabeth 1943 pt 5 - deck & main batteries 1/350 Trumpeter (1 část)

DETAIL

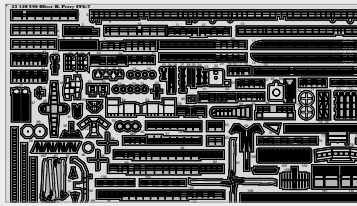

53150 USS Oliver H. Perry FFG-7 1/350 Academy (1 část)

DETAIL

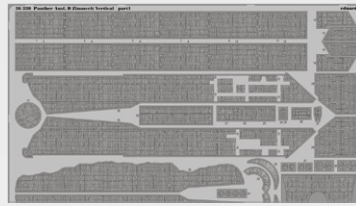

36330 Panther Ausf. D Zimmerit Vertical 1/35 Tamiya (1 část)

DETAIL

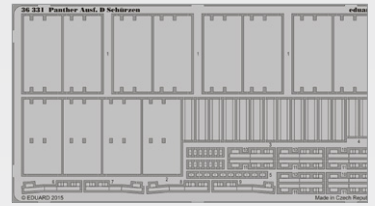

36331 Panther Ausf. D Schürzen 1/35 Tamiya (1 část)

DETAIL

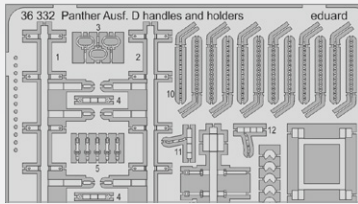

36332 Panther Ausf. D handles and holders 1/35 Tamiya (1 část)

DETAIL



48863 F-86F-30 upgrade set 1/48 Eduard (1 část)

DETAIL

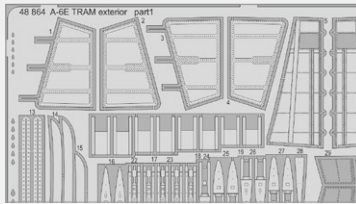

48864 A-6E TRAM exterior 1/48 Hobby Boss (2 části)

DETAIL

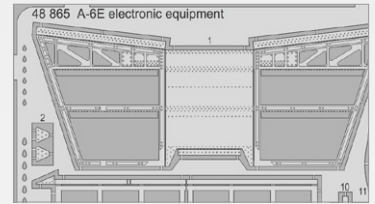

48865 A-6E electronic equipment 1/48 Hobby Boss (1 část)

DETAIL

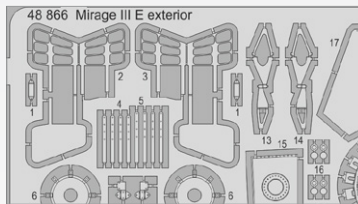

48866 Mirage III E exterior 1/48 Kinetic (1 část)

DETAIL

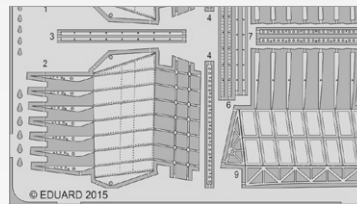

48867 Do 215B-5 Nightfighter landing flaps 1/48 ICM (1 část)

DETAIL



48868 Do 215B-5 Nightfighter radar antennas 1/48 ICM (1 část)

DETAIL

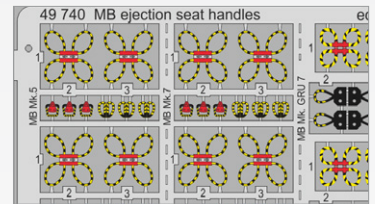

49740 MB ejection seat handles 1/48 (1 část)

DETAIL

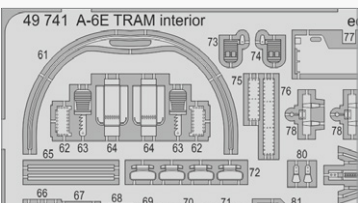

49741 A-6E TRAM interior 1/48 Hobby Boss (2 části)

DETAIL

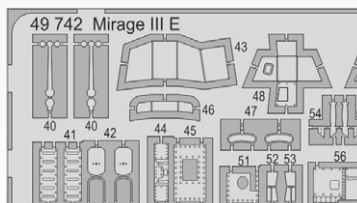

49742 Mirage III E 1/48 Kinetic (2 části)

DETAIL

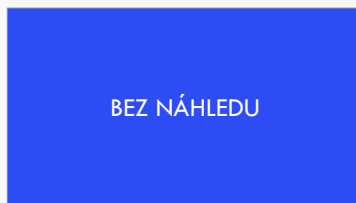

49743 He 51B.1 1/48 Roden (1 část)

DETAIL

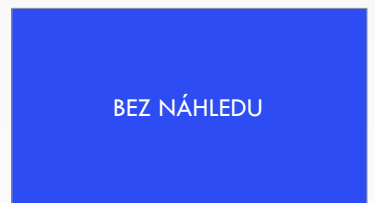

49744 Fokker Dr.I 1/48 Revell (1 část)

DETAIL



49745 Do 215B-5 Nightfighter 1/48 ICM (2 části)

DETAIL

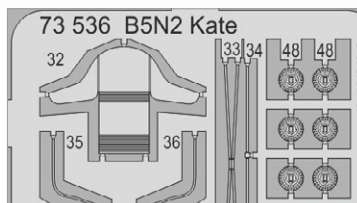

73536 B5N2 Kate 1/72 Airfix (2 části)

DETAIL

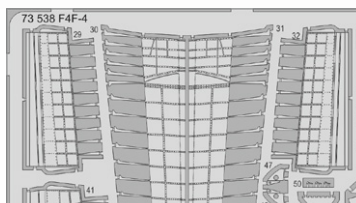

73538 F4F-4 1/72 Airfix (1 část)

DETAIL

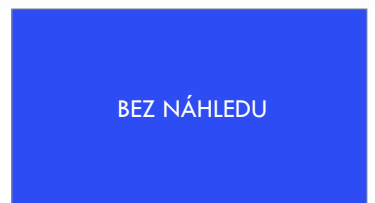

73539 Su-24MR 1/72 Trumpeter (2 části)

DETAIL

NOVINKY PROSINEC 2015

RYCHLÝ NÁHLED
PRO DETAIL KLIKNĚTE NA TLAČÍTKO

FOTOLEPTY

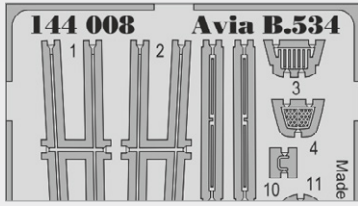

144008 Avia B.534
1/144 Eduard
(1 část)

DETAIL

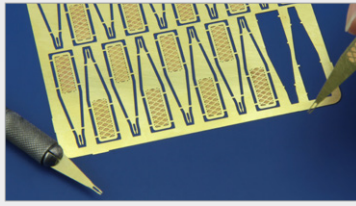

00037 Dropper - short version
(1 část)

DETAIL

ZOOM

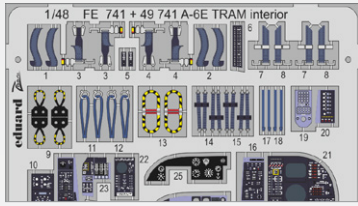

FE741 A-6E TRAM interior
1/48 Hobby Boss
(1 část)

DETAIL

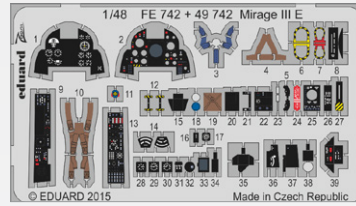

FE742 Mirage III E interior
1/48 Kinetic
(1 část)

DETAIL

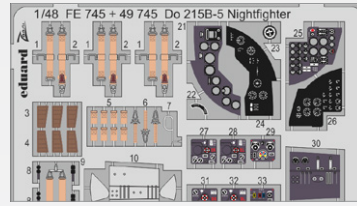

FE745 Do 215B-5 Nightfighter
1/48 ICM
(1 část)

DETAIL

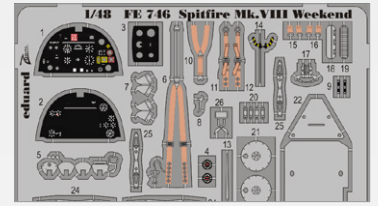

FE746 Spitfire Mk.VIII Weekend
1/48 Eduard
(1 část)

DETAIL

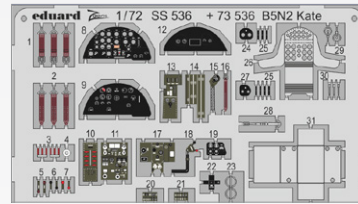

SS536 B5N2 Kate
1/72 Airfix
(1 část)

DETAIL



SS539 Su-24MR
1/72 Trumpeter
(1 část)

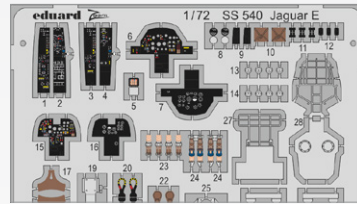

SS540 Jaguar E
1/72 Hobby Boss
(1 část)

DETAIL

BRASSIN

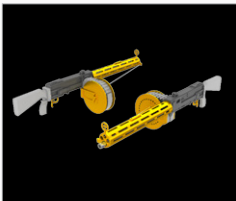

632070 MG 14 Parabellum
WWI gun 1/32

DETAIL

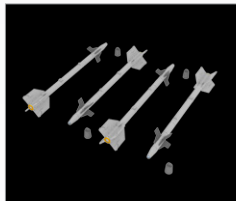

648197 AIM 9J Sidewinder
1/48

DETAIL

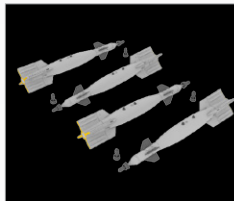

648236 GBU-16
1/48

DETAIL

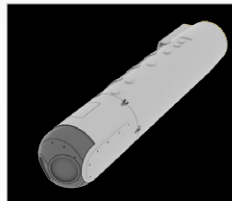

648237 AN/AAQ-28(V)
Litening pod 1/48

DETAIL

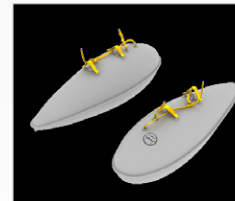

648238 US 75gal metal drop
tanks 1/48

DETAIL

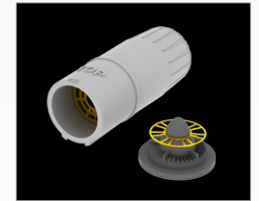

672079 F-4J exhaust nozzles
1/72 Academy

DETAIL

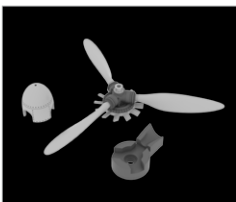

672086 Fw 190A propeller
1/72 Eduard

DETAIL

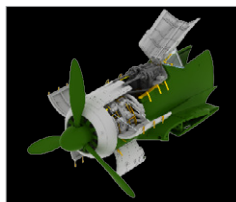

672088 Fw 190A-8 engine &
fuselage guns 1/72 Eduard

DETAIL

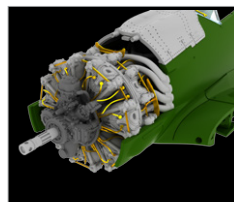

672082 Fw 190A-8 engine
1/72 Eduard

DETAIL

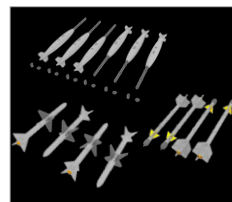

672089 F-4 armament
1/72

DETAIL

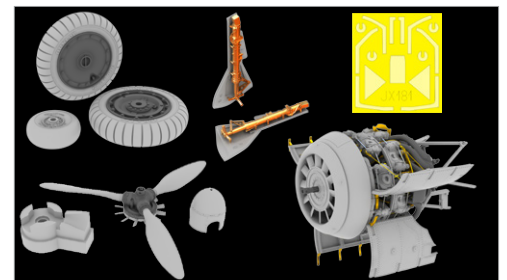

SIN63207 Fw 190F-8 PART II.
1/32

DETAIL

WEEKEND edition

Spitfire Mk.VIII v 1/48 v edici Weekend
(forma z roku 2015).

ZÁKLADNÍ INFO:

NÁZEV: **Spitfire Mk.VIII**

KAT. Č.: 84139

MĚŘÍTKO: 1/48

EDICE: Weekend

OBSAH:

RÁMEČKY: Eduard

FOTOLEPTY: NE

KRYCÍ MASKA: NE

MARKINGY: 2

BRASSIN: NE

OBTISKY: Eduard

PŘÍBUZNÉ PRODUKTY:

648201 Spitfire Mk.VIII gun bays (Brassin)

648200 Spitfire Mk.VIII engine (Brassin)

648199 Spitfire Mk.VIII cockpit (Brassin)

48834 Spitfire Mk.VIII landing flaps (fotolept)

48835 Spitfire Mk.VIII surface panels (fotolept)

49074 Spitfire Mk.VIII seatbelts
SUPER FABRIC (fotolept)

648133 Spitfire 30gal slipper tank (Brassin)

648120 Spitfire - radio compartment (Brassin)

648099 Spitfire exhaust stacks fishtail (Brassin)

EX483 Spitfire Mk. VIII (maska)



ČÁSTI MODELU

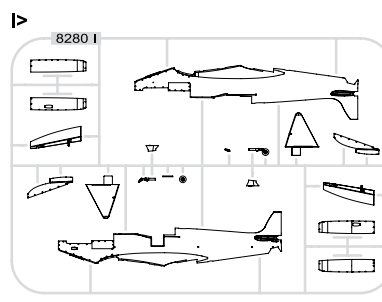
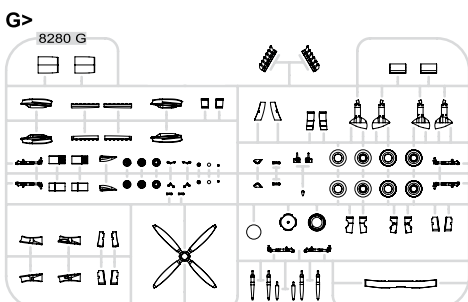
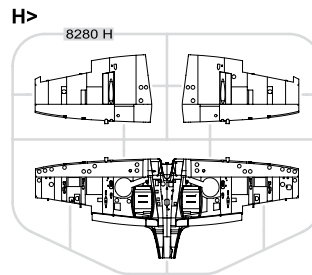
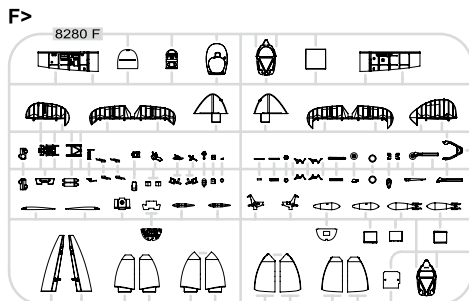
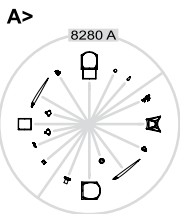
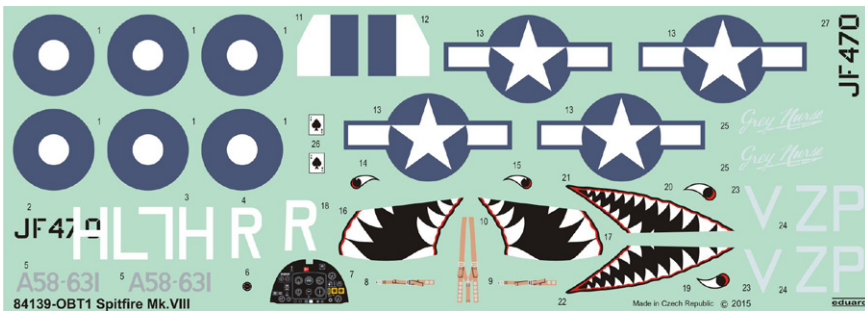

První vydání stavebnice Avia B.534 v 1/144 (forma z roku 2015). Stavebnice obsahuje díly pro stavbu 4 modelů raných verzí letounu.

ZÁKLADNÍ INFO:

NÁZEV: Avia B.534 early series

KAT. Č.: 4451

MĚŘÍTKO: 1/144

EDICE: SUPER44 **QUATTRO COMBO**

OBSAH:

SPRUES: Eduard

FOTOLEPTY: NE

KRYCÍ MASKA: 1 (bez náhledu)

MARKINGY: 6

OBTISKY: Eduard

BRASSIN: NE

PŘÍBUZNÉ PRODUKTY:

144008 Avia B.534 (fotolept)



Avia B.534 3. série, JFS 4, Fürth-Herzogenaurach, léto 1942



Avia B.534 3. série, Letecký pluk 4, 34. stíhací letka, Hradec Králové, Československo, srpen 1937



Avia B.534 3. série, FFS A/B 115, Wels, 1939 - 1941

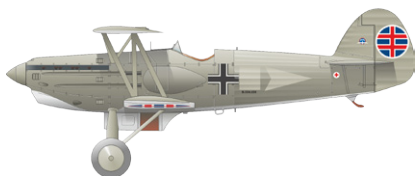

Avia B.534 3. série, Letecký pluk 3, 37. stíhací letka, Piešťany, Československo, léto 1938



B.534, I. série, LP 4, Hradec Králové, 1937



B.534 II. série, LP 3, Slovensko, 1937

ČÁSTI MODELU

A 3x

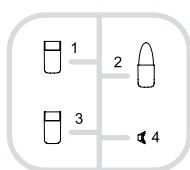

B 4x

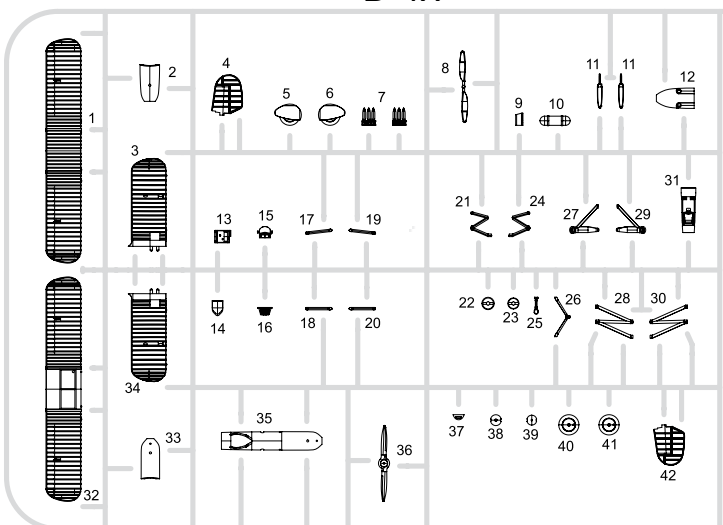

C

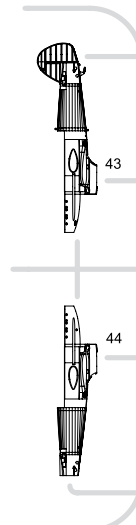

E

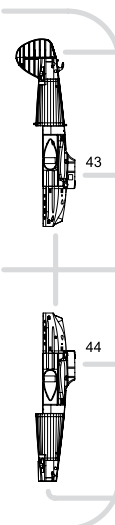

D



G



ULTIMATE SABRE



eduard
LIMITED EDITION

Limitovaná edice stavebnice F-86F-30
v 1/48.

ZÁKLADNÍ INFO:

NÁZEV: **Ultimate Sabre (F-86F-30 Sabre)**

KAT. Č.: 1163

MĚŘÍTKO: 1/48

EDICE: Limited edition

OBSAH:

RÁMEČKY: Hasegawa

FOTOLEPTY: 1 barvený (bez náhledu)

KRYCÍ MASKA: 1 (bez náhledu)

MARKINGY: 5

BRASSIN: sedačka

OBTISKY: Cartograf



ČÁSTI MODELU

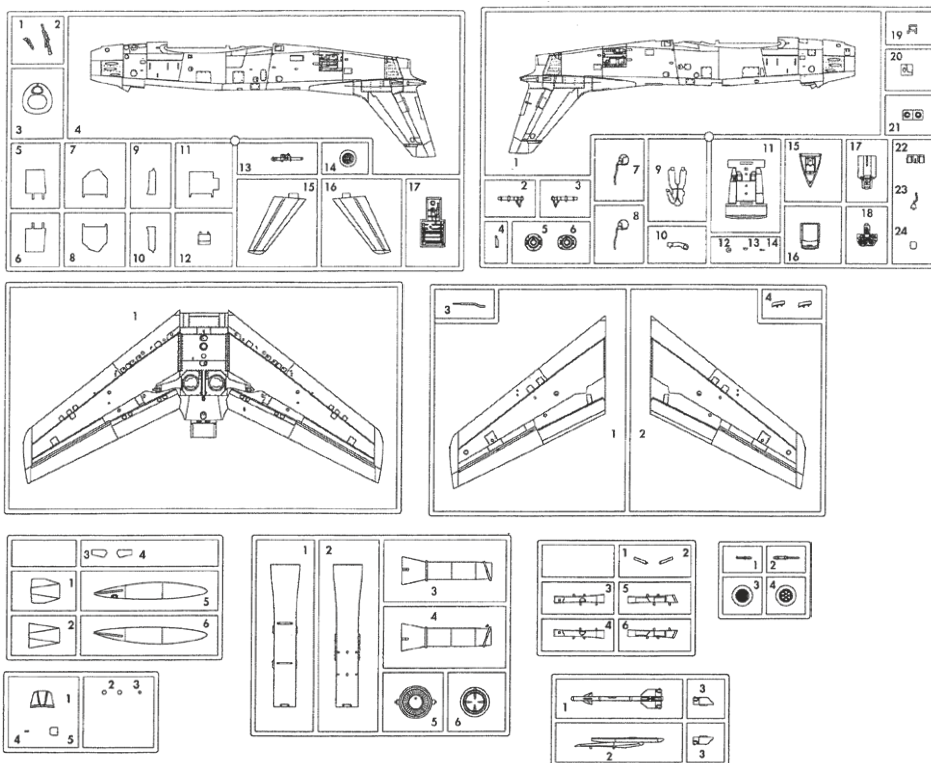

Fw 190A-8 v 1/72 (forma z roku 2015) v edici Royal Class. Obsahuje díly pro stavbu 4 modelů ve 3 variantách – kromě Fw 190A-8 také první vydání A-8/R2 (Sturmbock / pancéřovaný letoun) a A-8/R11 (noční stíhací verze). Bonusy této edice jsou pивní sklenice s emblémem Fw 190A-8, úlomek skutečného Fw 190A-8 s certifikátem autentičnosti.

ZÁKLADNÍ INFO:

NÁZEV: **Fw 190A-8**

KAT. Č.: R0012

MĚŘÍTKO: 1/72

EDICE: Royal Class

OBSAH:

RÁMEČKY: Eduard

FOTOLEPTY: 8 ks (bez náhledu)

KRYCÍ MASKA: 1 (bez náhledu)

MARKINGY: 12

OBTISKY: Cartograf

BRASSIN: Kola (4 páry)

PŘÍBUZNÉ PRODUKTY:

73033 Fw 190A-8 seatbelts SUPERFABRIC (fotolept)

72611 Fw 190A-8 (fotolept)

672081 Fw 190A-8 cockpit (Brassin)

672084 Fw 190A-8 MG 131 mount (Brassin)

672082 Fw 190A-8 engine (Brassin)

672086 Fw 190A propeller (Brassin)

672088 Fw 190A-8 engine & fuselage guns (Brassin)

672085 Fw 190A exhaust stacks (Brassin)



Fw 190A-8
1/72



Pivní sklenice s
emblémem Fw 190A-8



Stavebnice bude obsahovat jeden ze šesti vzorů dle náhodného výběru. Design potisku vychází z historických emblémů významných jednotek používajících Fw 190A-8.



ČÁSTI MODELU

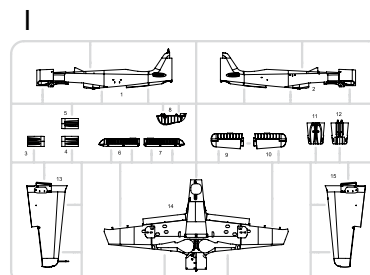
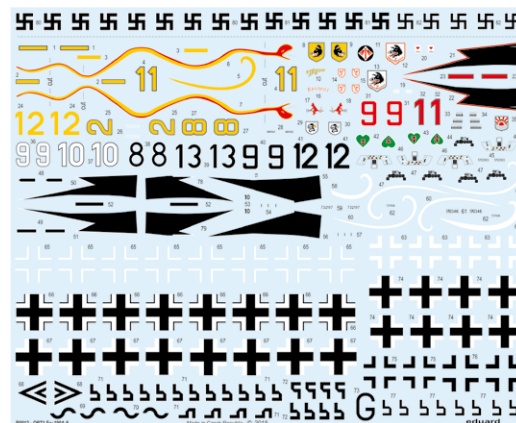
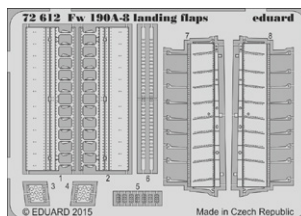
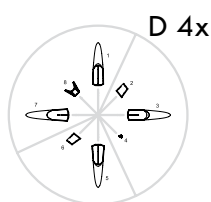
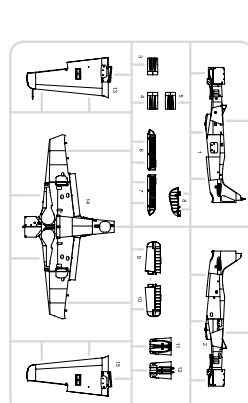
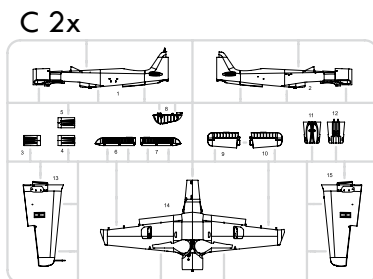
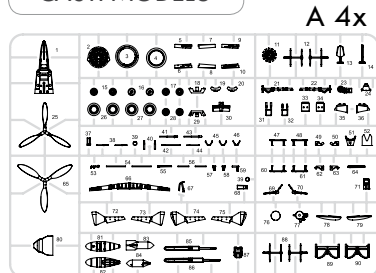

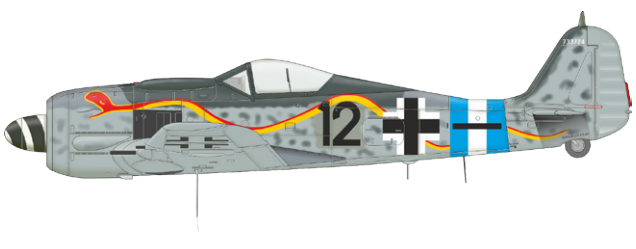
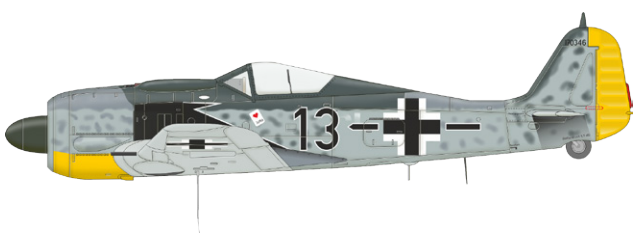
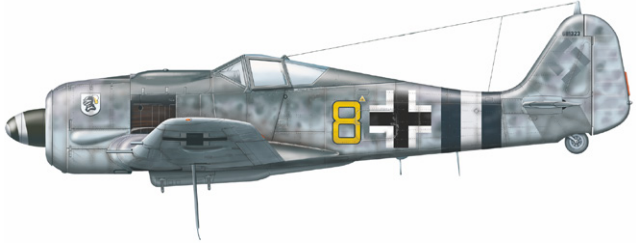
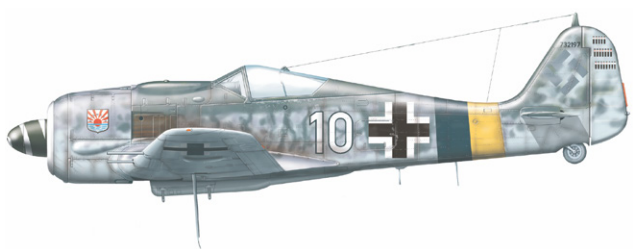
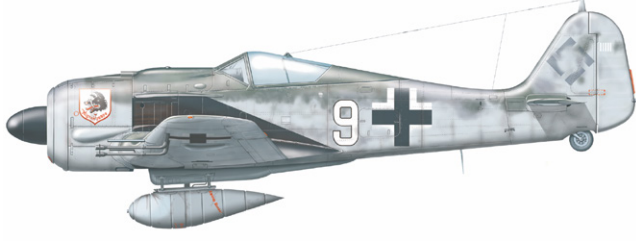
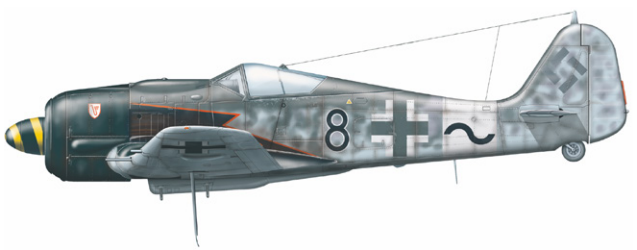
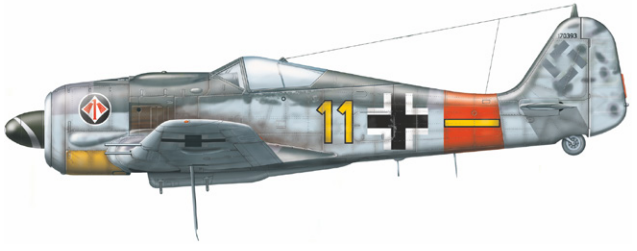
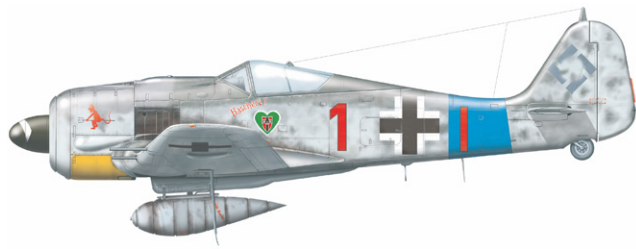
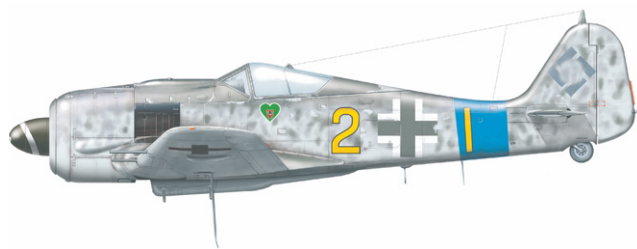

CERTIFICATE OF AUTHENTICITY
 Museum of Air Battle over the Ore Mountains on September 11th, 1944
 in Kovařík, Czech Republic
 confirms herein that the enclosed metal piece originates from the
Fw 190A-8/R2 Sturmböck
 which was shot down in combat with the 8th USAAF on September Eleventh, 1944
 and crashed in the vicinity of Kovařík, and is identified as
W.Nr. 681323 "Gelbe 8"
 flown by Fw. Friedrich-Karl Frank
 7./II. (Sturm) / Jagdgeschwader 4



Albert E. Trommer ©96
 431 86 Kovařík
 Czech Republic
 WWW.MUSEUM119.CZ



Kovařík,
 February 5th, 2007

Jan Zlánský, Ph.D.
 director of the Museum.

Úlomek skutečného Fw 190A-8 s certifikátem autentičnosti.



53149 HMS Queen Elizabeth 1943 pt 5 - deck & main batteries 1/350 Trumpeter

53150 USS Oliver H. Perry FFG-7 1/350 Academy

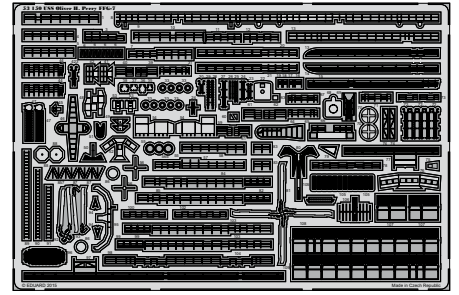
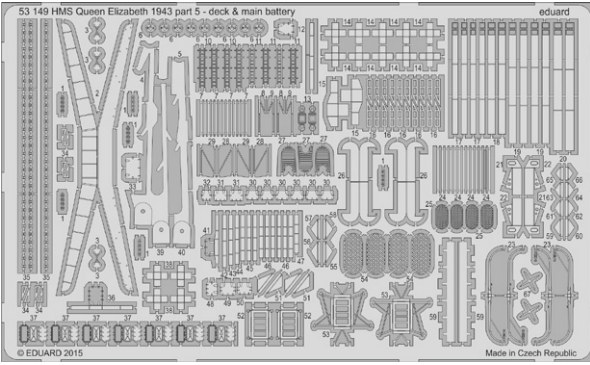

36330 Panther Ausf. D Zimmerit Vertical 1/35 Tamiya

36331 Panther Ausf. D Schürzen 1/35 Tamiya

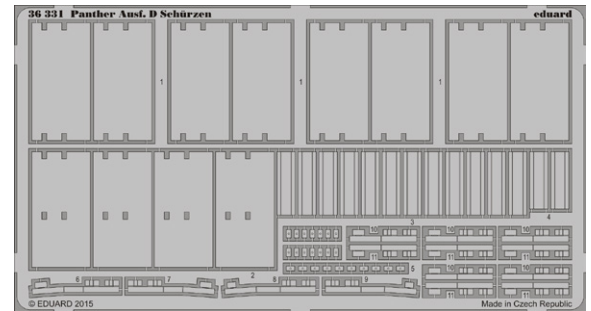
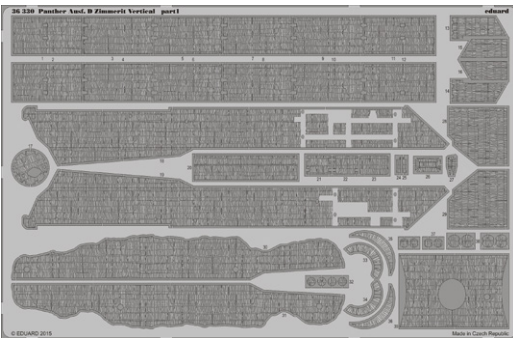

36332 Panther Ausf. D handles and holders 1/35 Tamiya

48864 A-6E TRAM exterior 1/48 Hobby Boss

48865 A-6E electronic equipment 1/48 Hobby Boss

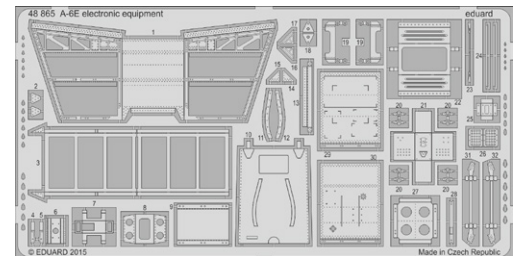
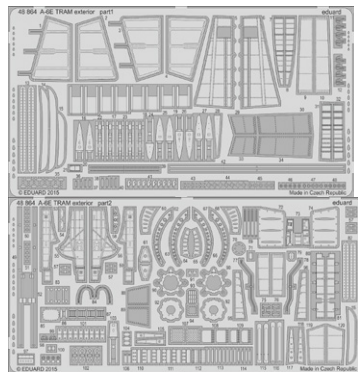
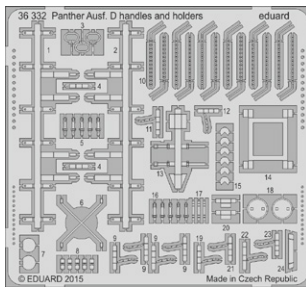

48866 Mirage III E exterior 1/48 Kinetic

48867 Do 215B-5 Nightfighter landing flaps 1/48 ICM

48868 Do 215B-5 Nightfighter radar antennas 1/48 ICM

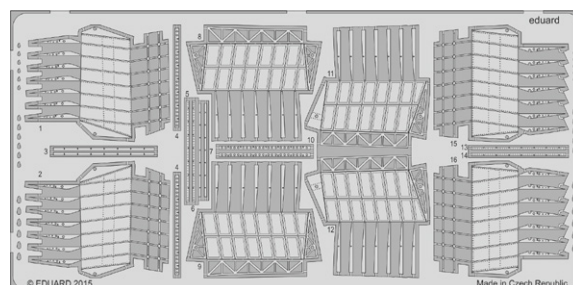
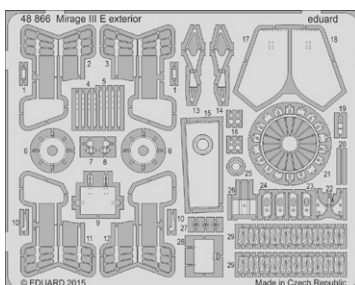

49740 MB ejection seat handles 1/48

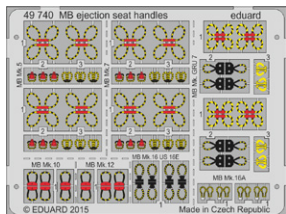

49741 A-6E TRAM interior 1/48 Hobby Boss

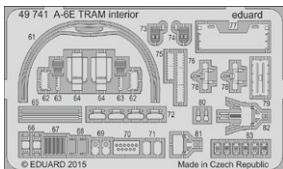

49742 Mirage III E 1/48 Kinetic

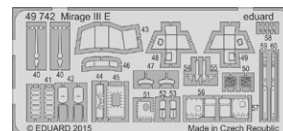

49745 Do 215B-5 Nightfighter 1/48 ICM

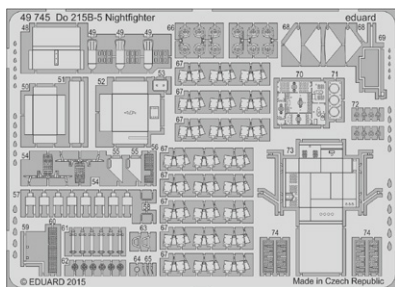

73536 B5N2 Kate 1/72 Airfix

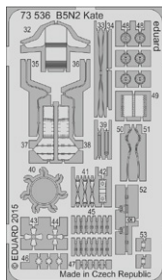

73538 F4F-4 1/72 Airfix

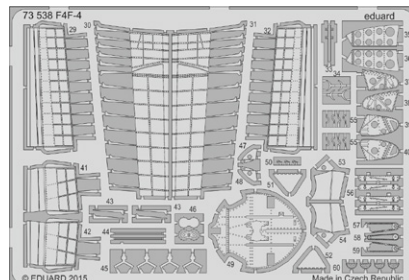

144008 Avia B.534 1/144 Eduard

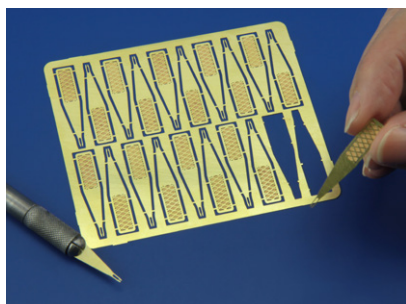
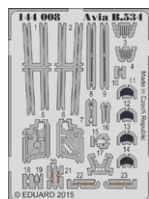

00037 Dropper - short version

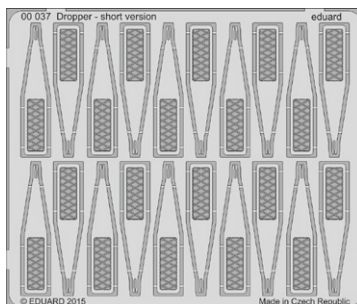

FE741 A-6E TRAM interior 1/48 Hobby Boss

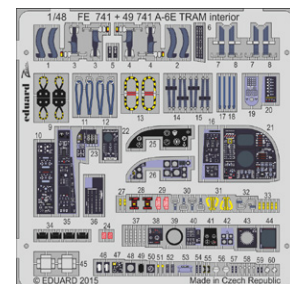

FE742 Mirage III E interior 1/48 Kinetic

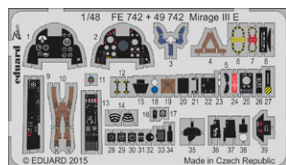

FE745 Do 215B-5 Nightfighter 1/48 ICM

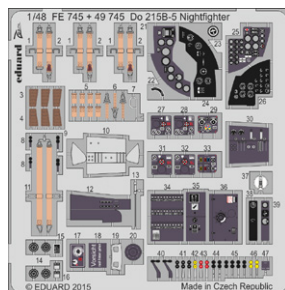

FE746 Spitfire Mk.VIII Weekend 1/48 Eduard

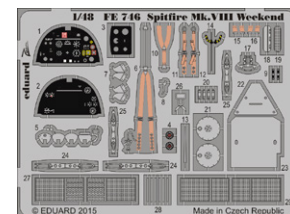

SS536 B5N2 Kate 1/72 Airfix

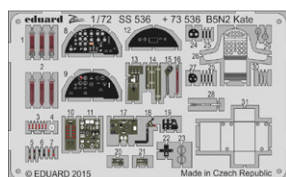

SS540 Jaguar E 1/72 Hobby Boss

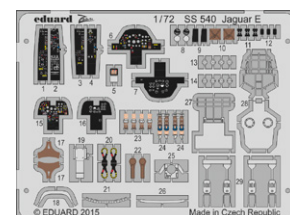

CX429 B5N2 Kate
1/72 Airfix

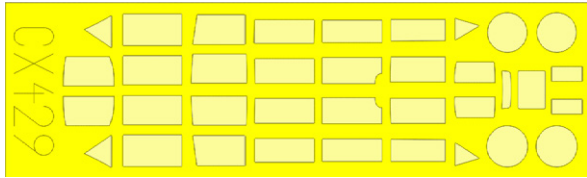

CX431 Jaguar E
1/72 Hobby Boss

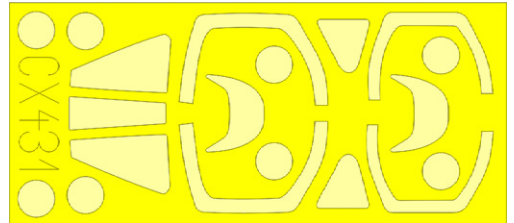

EX485 Do 215B-5 Nightfighter
1/48 ICM

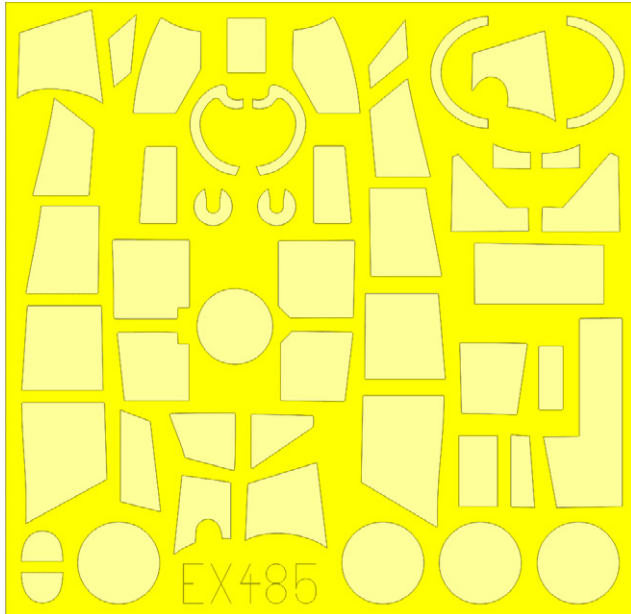

EX484 A-6E TRAM
1/48 Hobby Boss

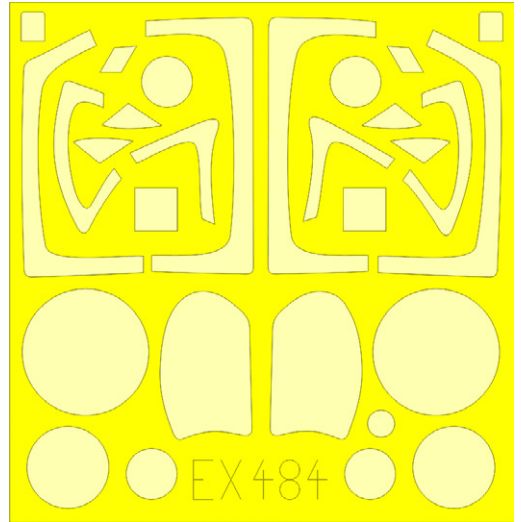

CX430 Su-24MR
1/72 Trumpeter

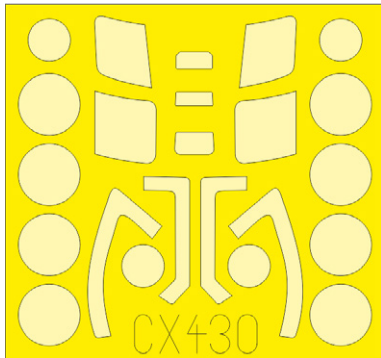

EX483 Spitfire Mk.VIII
1/48 Eduard

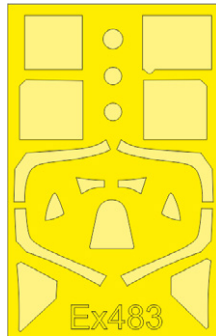

EX487 Mirage III E
1/48 Kinetic

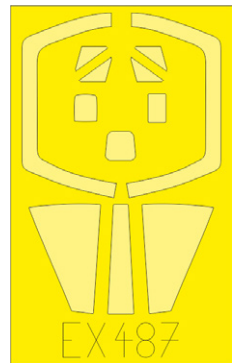

EX486 He 51B.1
1/48 Roden

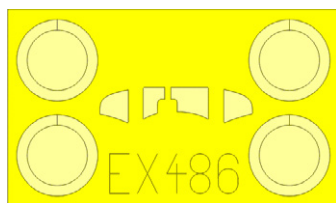

632070 MG 14 Parabellum WWI gun 1/32

Brassin sada - 2 kusy kulometů MG 14 Parabellum
v 1/32.

Sada obsahuje:

- resin: 6 dílů
- obtisk: ne
- lept: ano
- maska: ne

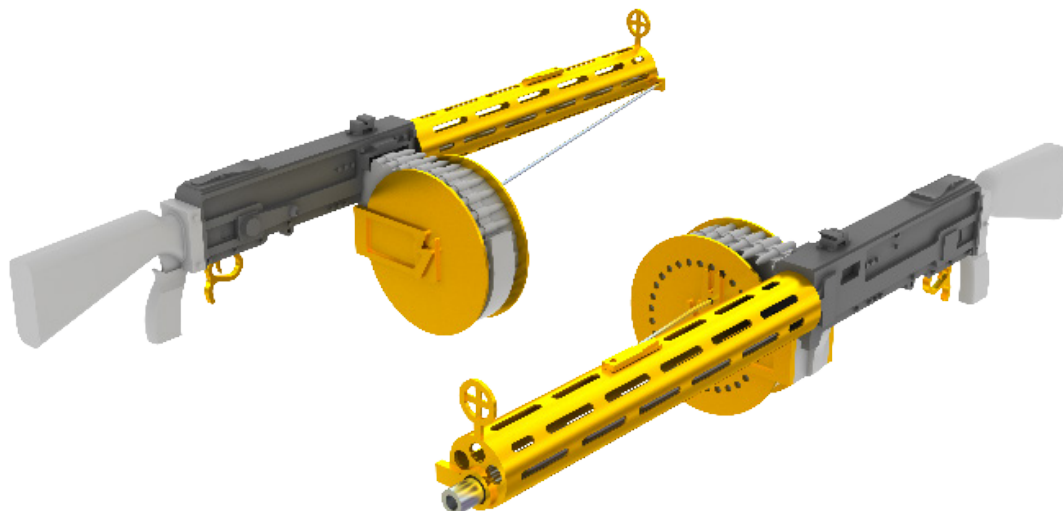

648197 AIM 9J Sidewinder 1/48

Brassin sada - 4 kusy raket AIM 9J Sidewinder
v 1/48.

Sada obsahuje:

- resin: 28 dílů
- obtisk: ano
- lept: ano
- krycí maska: ne

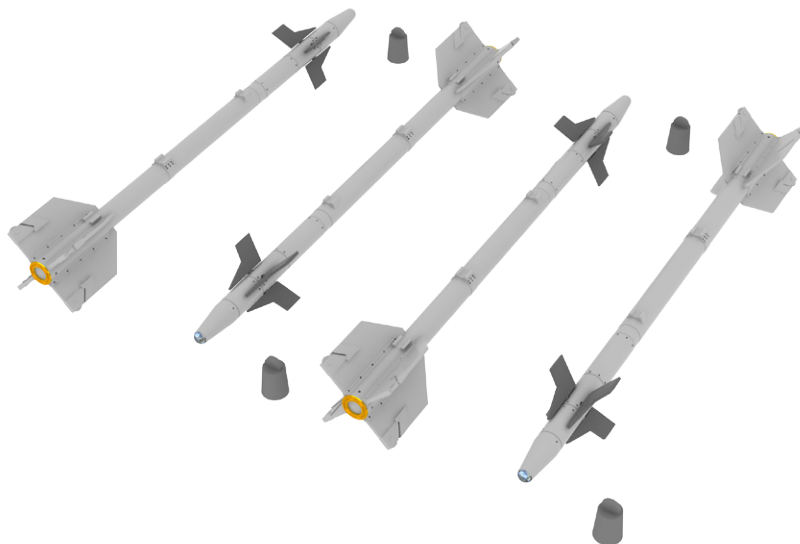

648236 GBU-16 1/48

Brassin sada - 4 kusy bomb GBU-16
v 1/48.

Sada obsahuje:

- resin: 28 dílů
- krycí maska: ne
- obtisk: ano
- lept: ano

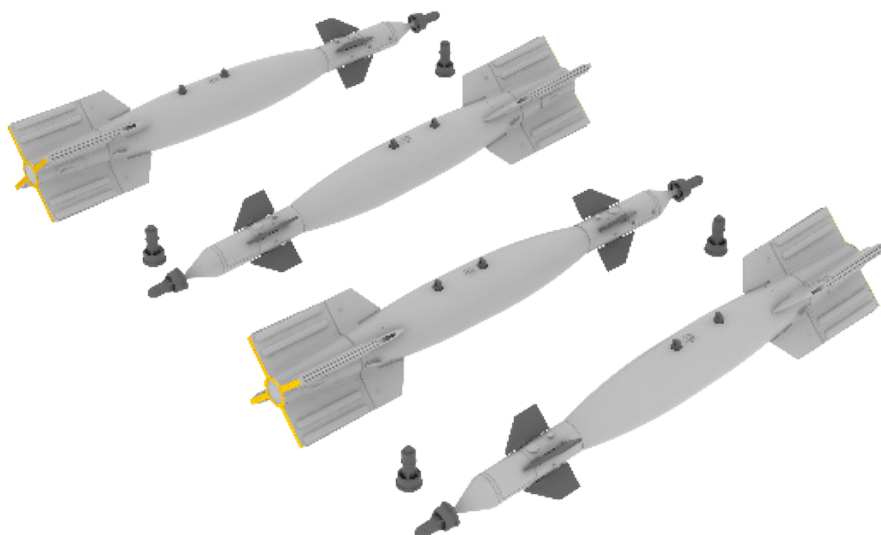

648237 AN/AAQ-28(V) Litening pod 1/48

Brassin sada – zaměřovací kontejner AN/AAQ-28(V)
Litening v 1/48.

Sada obsahuje:

- resin: 2 díly
- obtisk: ano
- lept: ano

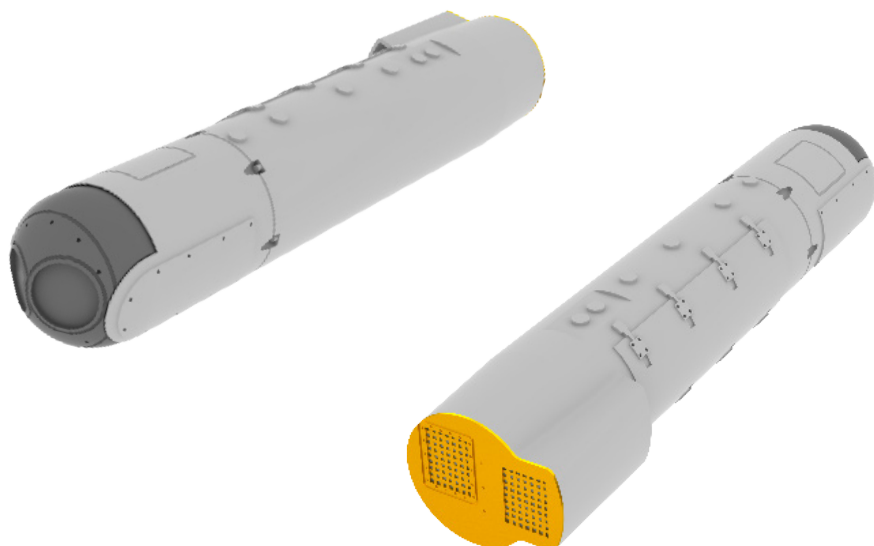

648238 US 75gal metal drop tanks 1/48

Brassin sada – 2 kusy US 75gal přídavných nádrží
v 1/48.

Sada obsahuje:

- resin: 2 díly
- obtisk: ano
- lept: ano
- maska: ne

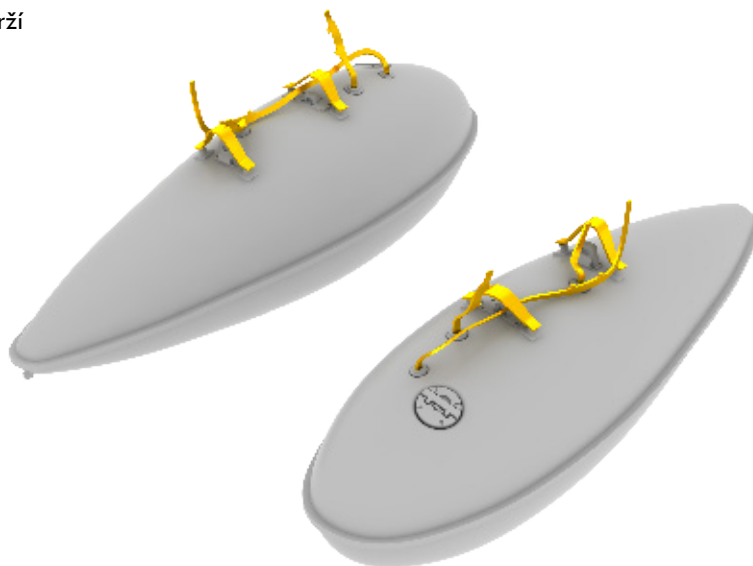

672079 F-4J exhaust nozzles 1/72 Academy

Brassin sada – 2 kusy trysek pro F-4J v 1/72
pro stavebnici od Academy.

Sada obsahuje:

- resin: 4 díly
- obtisk: ne
- lept: ano



672086 Fw 190A propeller 1/72 Eduard

Brassin sada- vrtule pro Fw 190A v 1/72 pro stavebnici od Eduardu. Přípravek pro usazování vrtulových listů je součástí sady.

Sada obsahuje:

- resin: 8 dílů
- obtisk: ne
- lept: ano
- krycí maska: ne

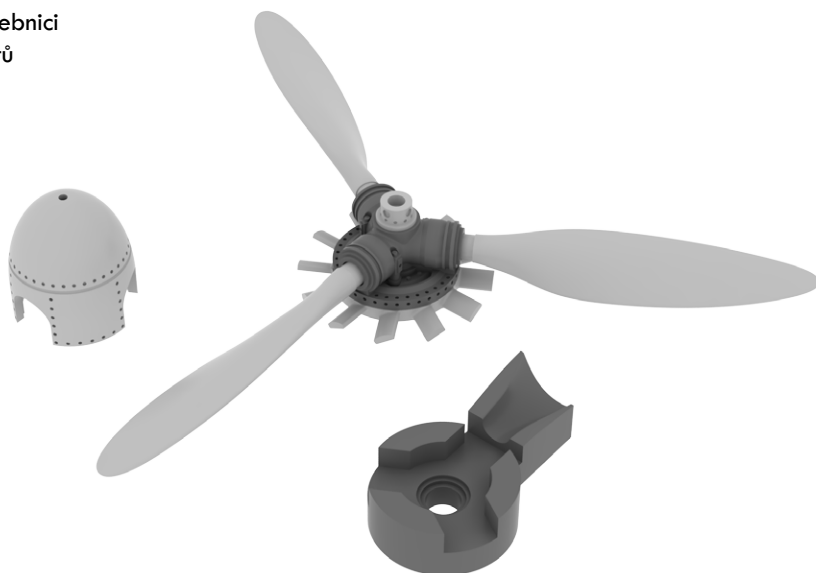

672088 Fw 190A-8 engine & fuselage guns 1/72 Eduard

Brassin sada pro Fw 190A-8 v 1/72 od Eduardu.
Sada obsahuje motor, zástavbu dvou kulometů a kryty.

Sada obsahuje:

- resin: 23 dílů
- obtisk: ne
- lept: ano
- krycí maska: ne

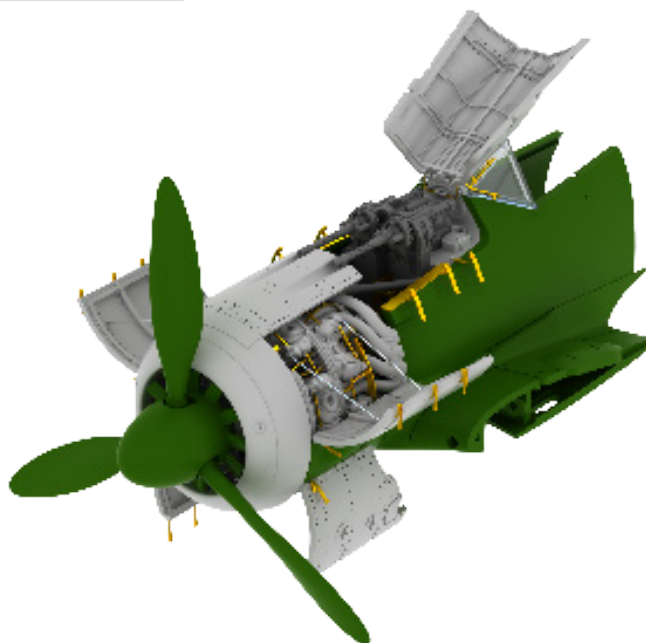

672082 Fw 190A-8 engine 1/72 Eduard

Brassin sada - motor pro Fw 190A-8 v 1/72 pro stavebnici od Eduardu.

Sada obsahuje:

- resin: 19 dílů
- obtisk: ne
- lept: ano
- krycí maska: ne

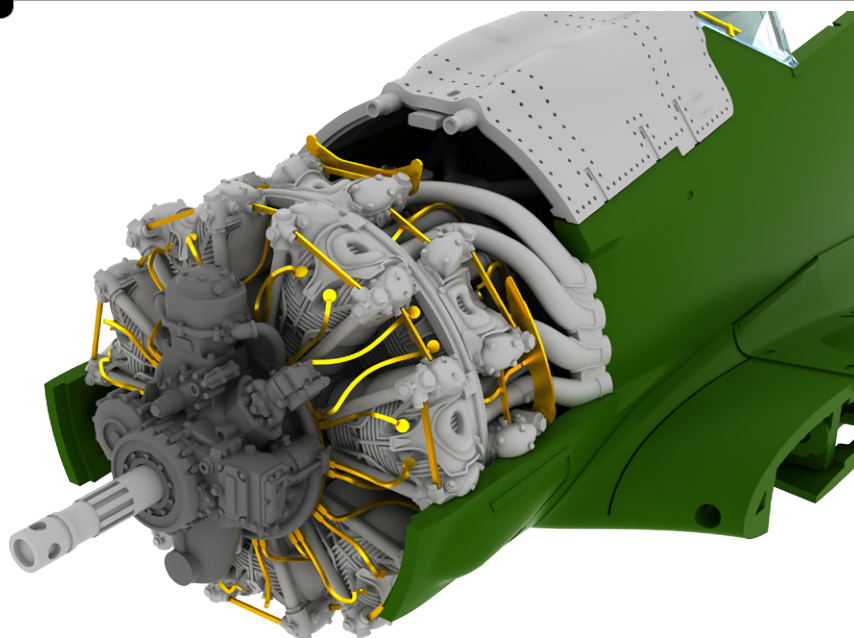

Brassin sada - výzbroj pro F-4 v 1/72. Sada obsahuje 18 kusů bomb Mk.82, 4 kusy raket AIM-9B Sidewinder a 4 kusy raket AIM-7E Sparrow.

Sada obsahuje:

- resin: 100 dílů
- obtisk: ano
- lept: ano
- krycí maska: ne

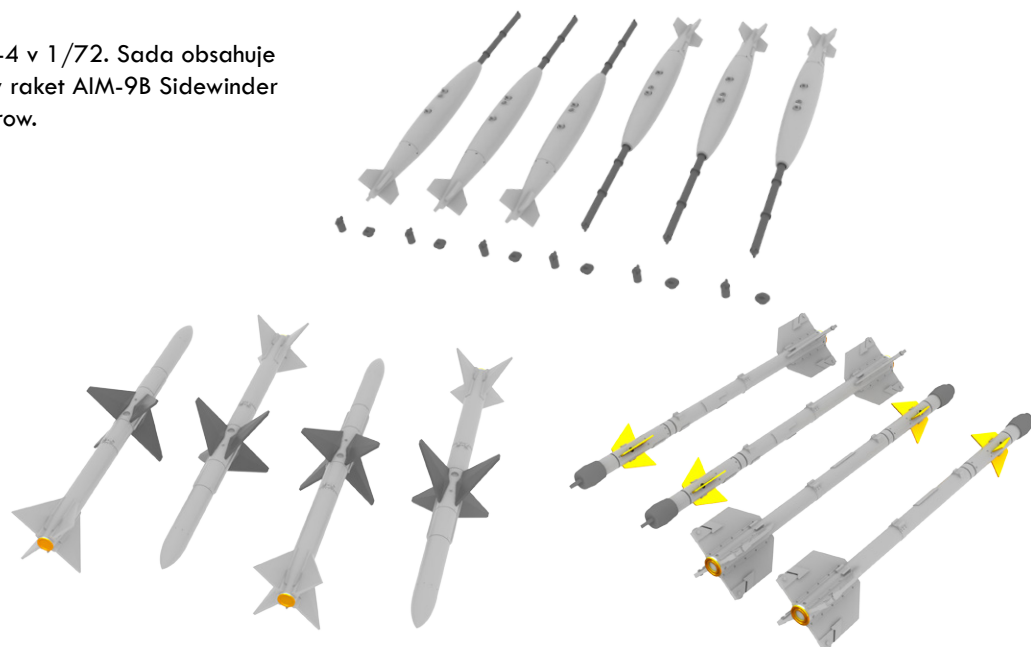

SIN63207 Fw 190F-8 PART II. 1/32 Revell

BIGSIN kolekce obsahující 4 samostatné Brassin sady a krycí masku pro Fw 190F-8 v 1/32 od Revellu.

- kola podvozku,
- podvozkové nohy (bronzové),
- motor,
- vrtule,
- krycí maska.

Všechny sady v této kolekci jsou dostupné samostatně, ovšem jejich spojení v edici BIG SIN znamená slevu až 30%.

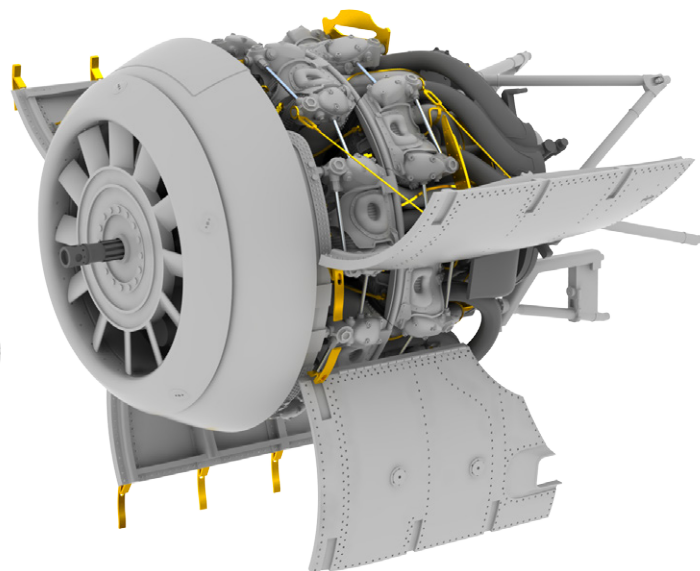
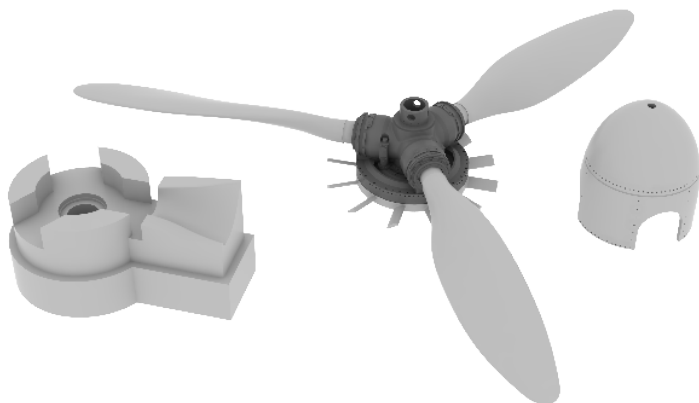
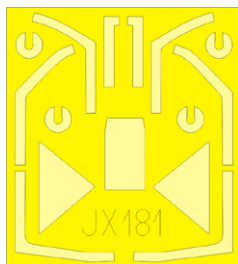

- 17039 HMS Dreadnought 1915
- 17530 Naval Figures Royal Navy
- 17530 Naval Figures Royal Navy

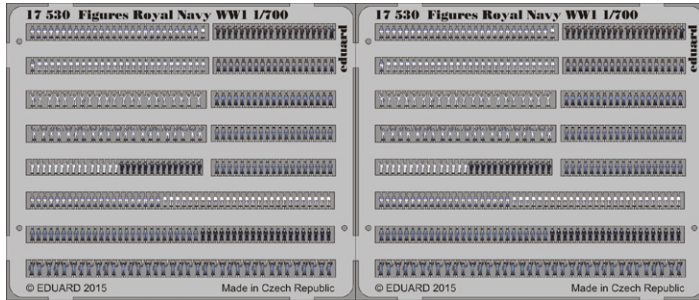
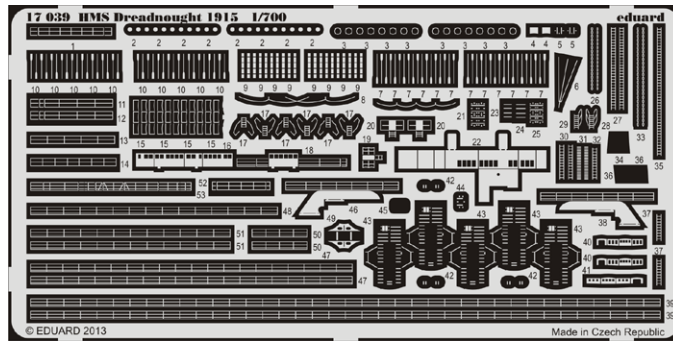

BIG3357 Ju 87G-2 1/32 Trumpeter

- 32378 Ju 87G-2 exterior
- 32847 Ju 87G-2 interior
- 33150 Ju 87G-2 interior
- JX183 Ju 87G-2
- 32848 Ju 87G-2 seatbelts

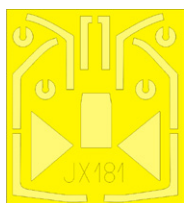
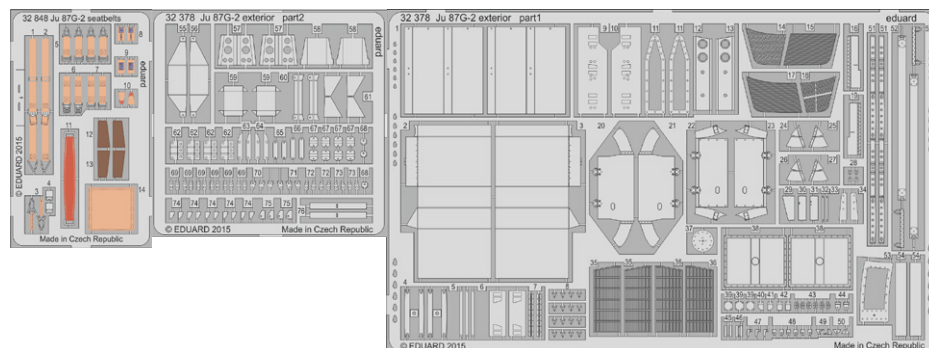
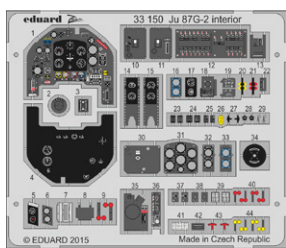
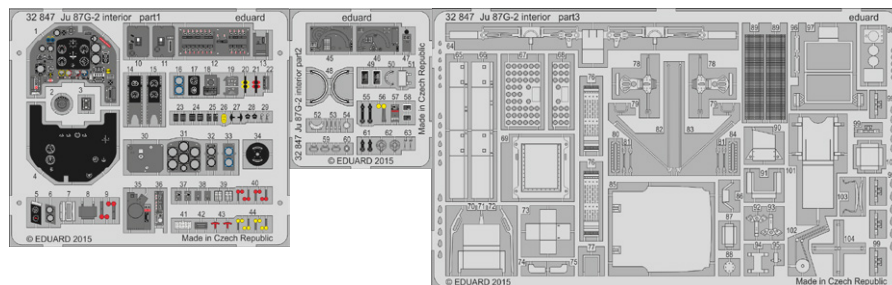

BIG-ED SETS

BIG49137 F-4D 1/48 Academy

- 48855 F-4D air brakes
- 48856 F-4D exterior
- 49729 F-4D interior S.A.
- 49730 F-4D seatbelts
- 49009 Remove Before Flight
- EX475 F-4D

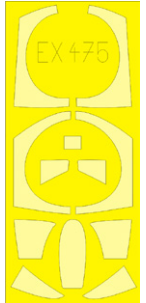
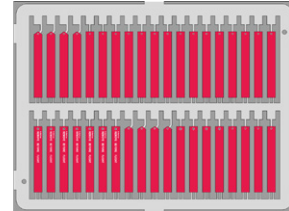
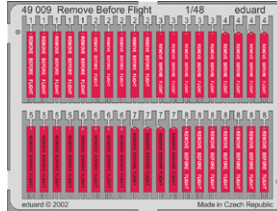
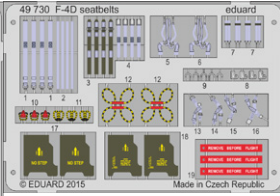
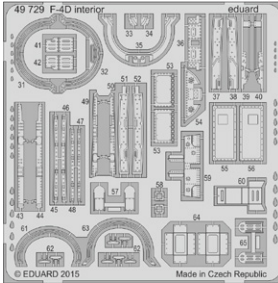
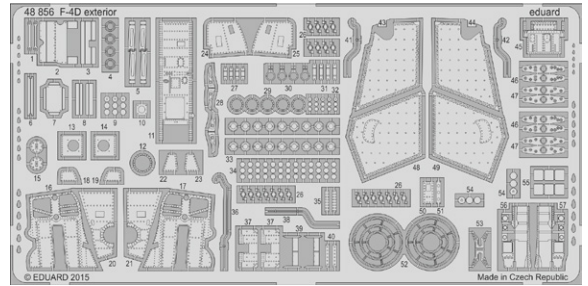
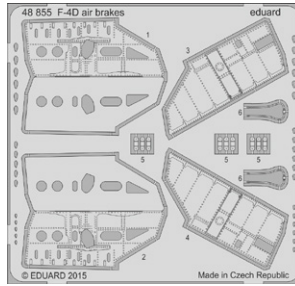

BIG49138 UH-1Y 1/48 KittyHawk

- 49731 UH-1Y S.A.
- 49732 UH-1Y seatbelts
- EX476 UH-1Y
- 49009 Remove Before Flight

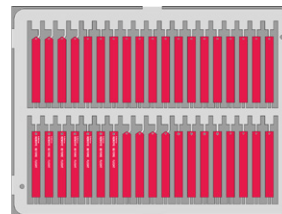
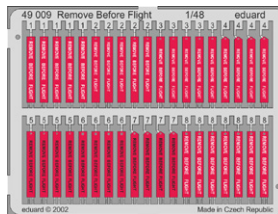
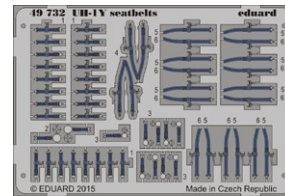
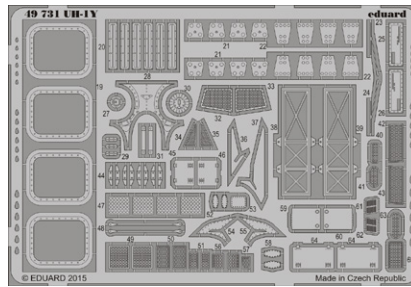
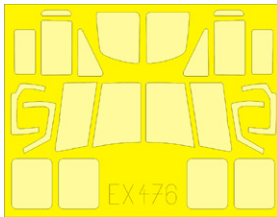

BIG72104 UTI MiG-15 1/72 Eduard

- 72607 UTI MiG-15 landing flaps
- 72608 UTI MiG-15 exterior
- 73490 MiG-15 Weekend
- CX427 UTI MiG-15

