









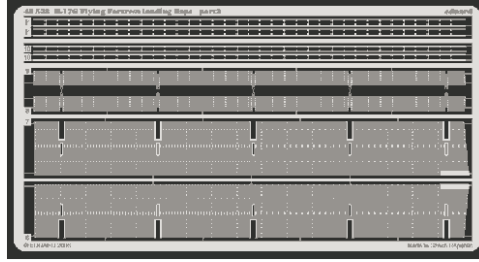
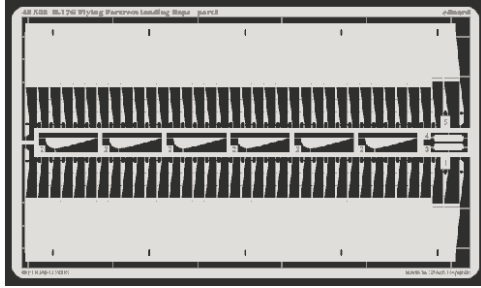

B-17G Flying Fortress landing flaps

1/48 scale detail set for Monogram kits • sada detailů pro modely 1/48 Monogram

eduard

48 528



-  APPLY EXPRESS MASK AND PAINT BEFORE GLUING
POUŽIT EXPRESS MASK NABARVIT PŘED SLEPENÍM
-  SYMMETRICAL ASSEMBLY
SYMETRICKÁ MONTÁŽ
-  REMOVE
ODSTRANIT
-  GRIND
OBROUSIT
-  DRILL HOLE
VRTAT OTVOR
-  BEND
OHNOUT
-  OPTION
VOLBA
-  REPLACE
NAHRADIT

 ORIGINAL KIT PARTS
PŮVODNÍ DÍLY STAVEBNICE

 PHOTO-ETCHED PARTS
LEPTANÉ DÍLY

 PARTS TO BE REMOVED
DÍLY K ODSTRANĚNÍ

 FILL
TMELIT

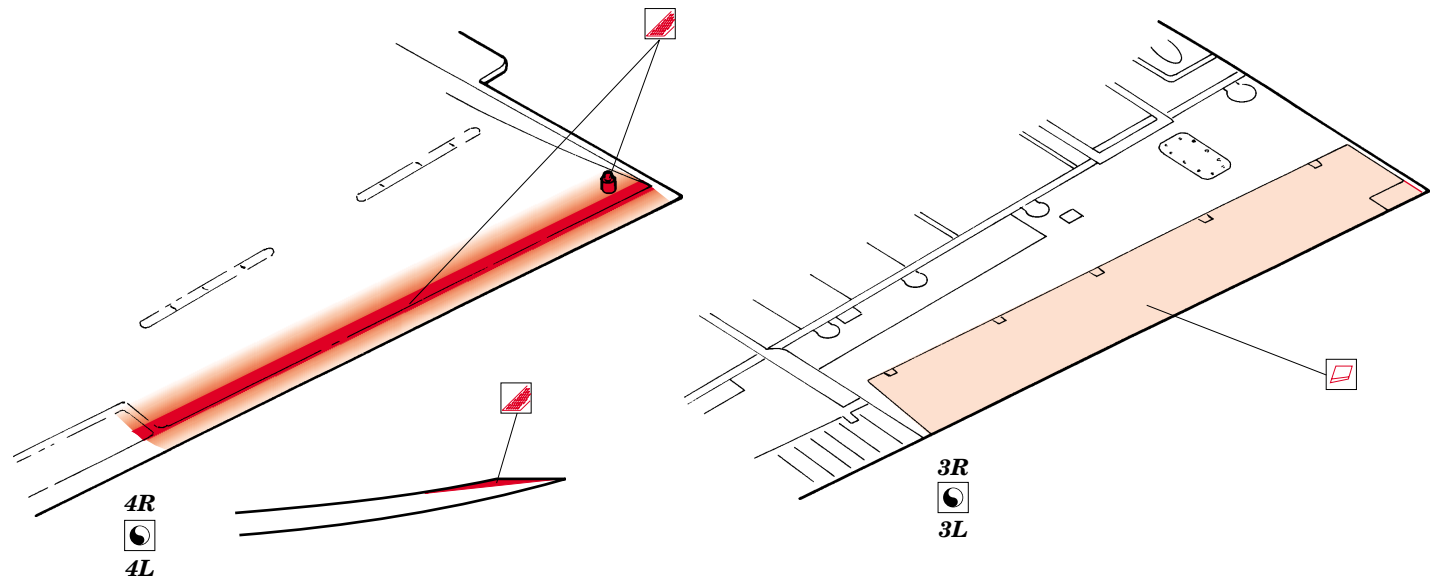

References : Aero Detail No.19 - Boeing B-17G
Squadron/Signal No.5516 - Walk Around B-17
War Bird Tech Series Vol.7 - Boeing B-17

