

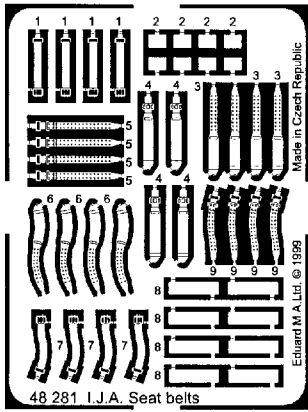







I.J.A. Seat belts

1/48 scale detail set for plastic kits



-  OPPOSITE SIDE
-  REMOVE
-  BEND
-  REPLACE
-  GRIND
-  OPTION

Ki-45, and so on

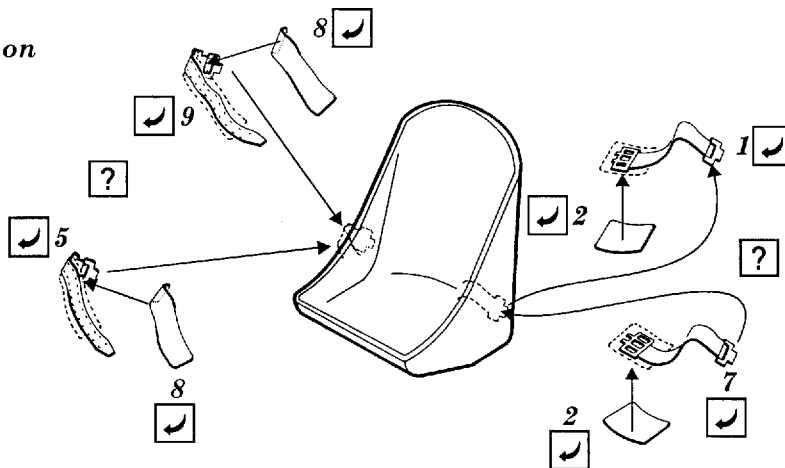

Ki-44, and so on

